

US00D561632S

(12) **United States Design Patent**
Allin

(10) **Patent No.:** **US D561,632 S**

(45) **Date of Patent:** **** Feb. 12, 2008**

(54) **RING**

(75) Inventor: **Miyuki Allin**, Paris (FR)

(73) Assignee: **Cartier Creation Studio, S.A.**, Geneva (CH)

(**) Term: **14 Years**

(21) Appl. No.: **29/255,478**

(22) Filed: **Mar. 8, 2006**

(30) **Foreign Application Priority Data**

Sep. 9, 2005 (EM) 000398748-0004

(51) **LOC (8) Cl.** **11-01**

(52) **U.S. Cl.** **D11/34**

(58) **Field of Classification Search** D11/3,
D11/26-39, 91, 92; 63/15, 15.1-15.4, 15.45,
63/15.5, 15.6, 15.65, 15.7, 37-28

See application file for complete search history.

(56) **References Cited**

U.S. PATENT DOCUMENTS

D363,252 S * 10/1995 Ambar et al. D11/34

D374,411 S * 10/1996 Ambar D11/34
D443,548 S * 6/2001 Haquet D11/26
D454,514 S * 3/2002 Gruosi D11/34
D493,741 S * 8/2004 Pachachi D11/26

* cited by examiner

Primary Examiner—Ian Simmons

Assistant Examiner—Melanie Levy

(74) *Attorney, Agent, or Firm*—Kalow & Springut LLP

(57) **CLAIM**

I claim the ornamental design for a ring, as shown and described.

DESCRIPTION

FIG. 1 is a perspective view of a ring.

FIG. 2 is a top view of a ring.

FIG. 3 is a bottom view of a ring.

FIG. 4 is a right side view of a ring.

FIG. 5 is a left side view of a ring.

FIG. 6 is a rear view of a ring; and,

FIG. 7 is a front view of a ring.

1 Claim, 4 Drawing Sheets

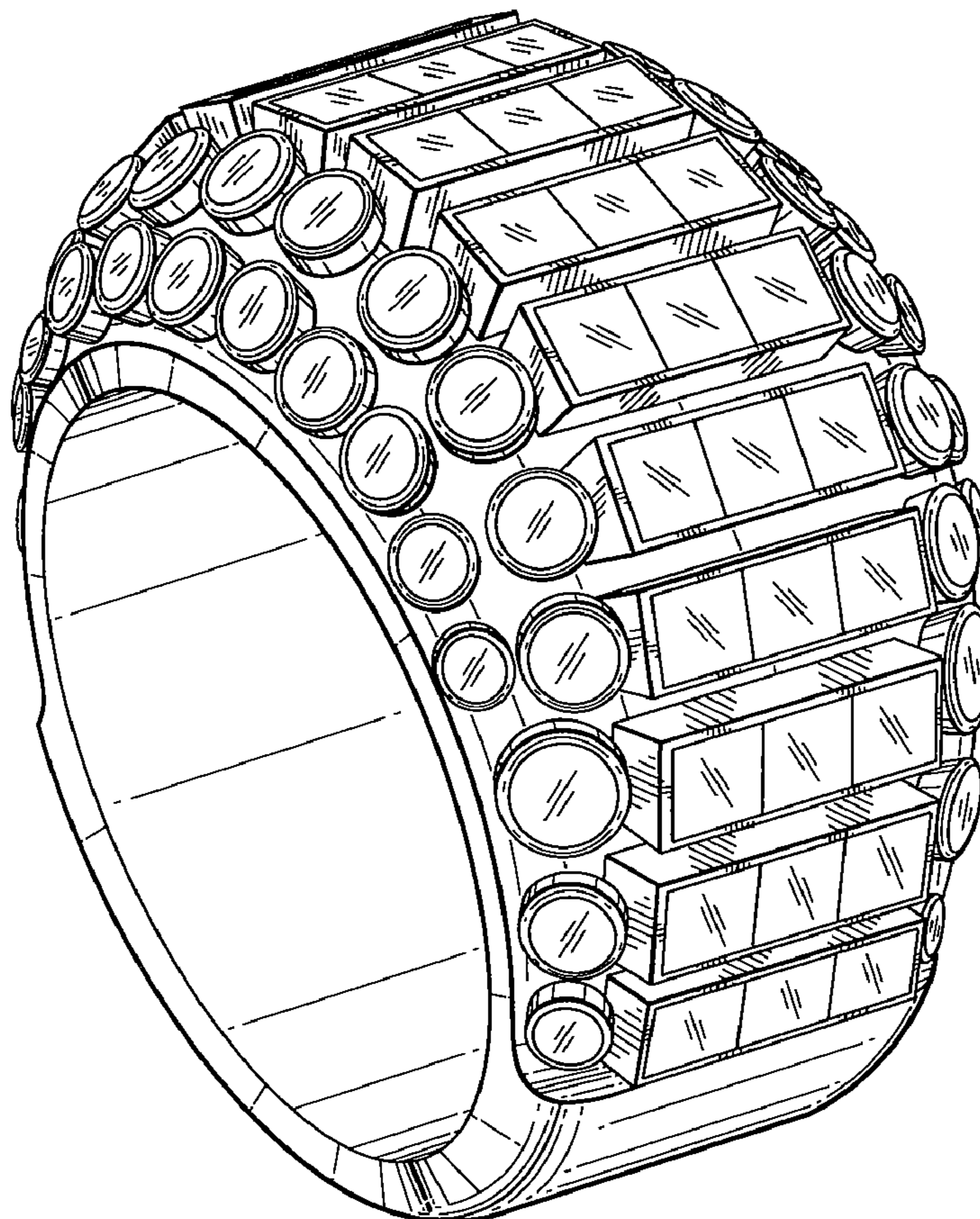

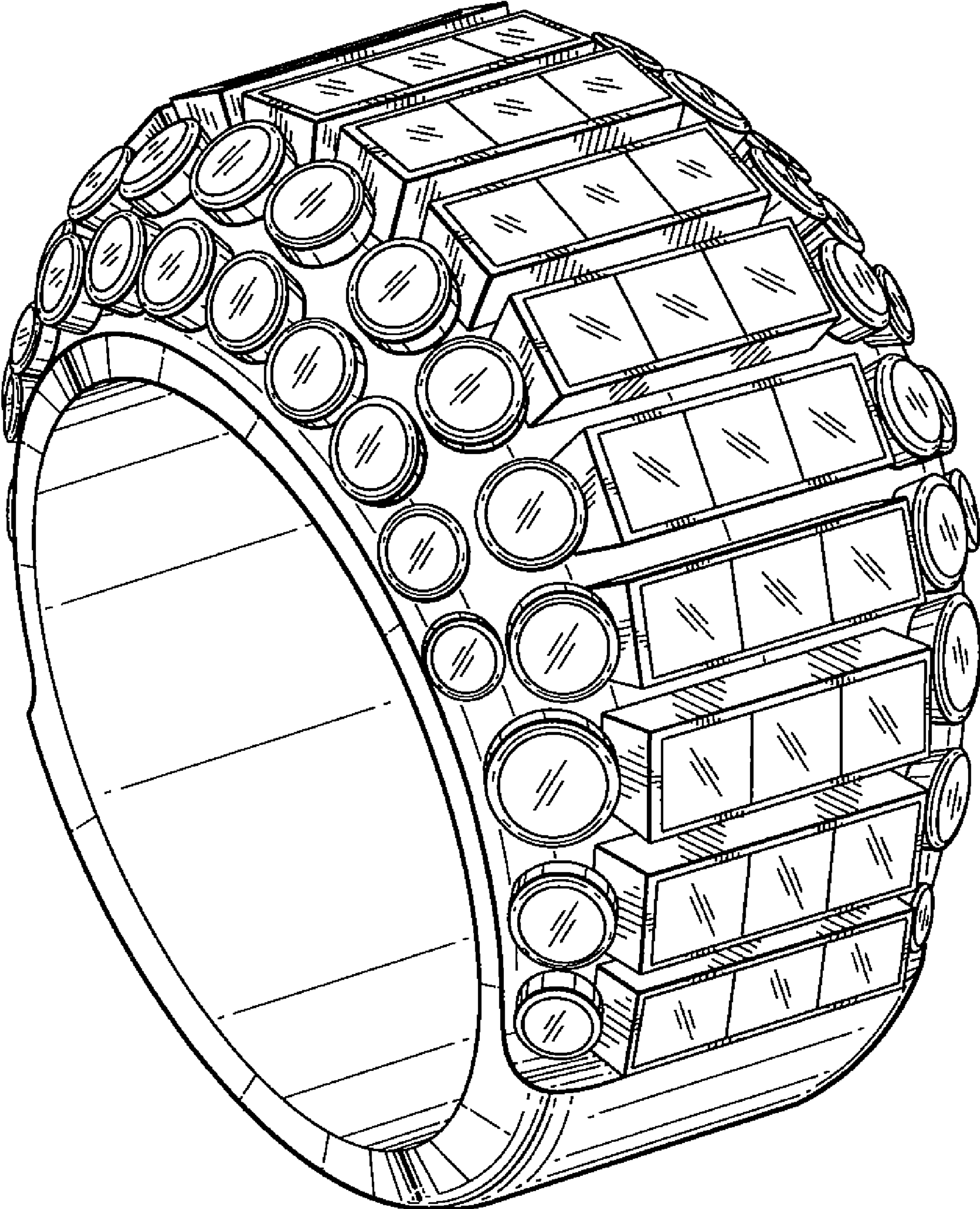

FIG. 1

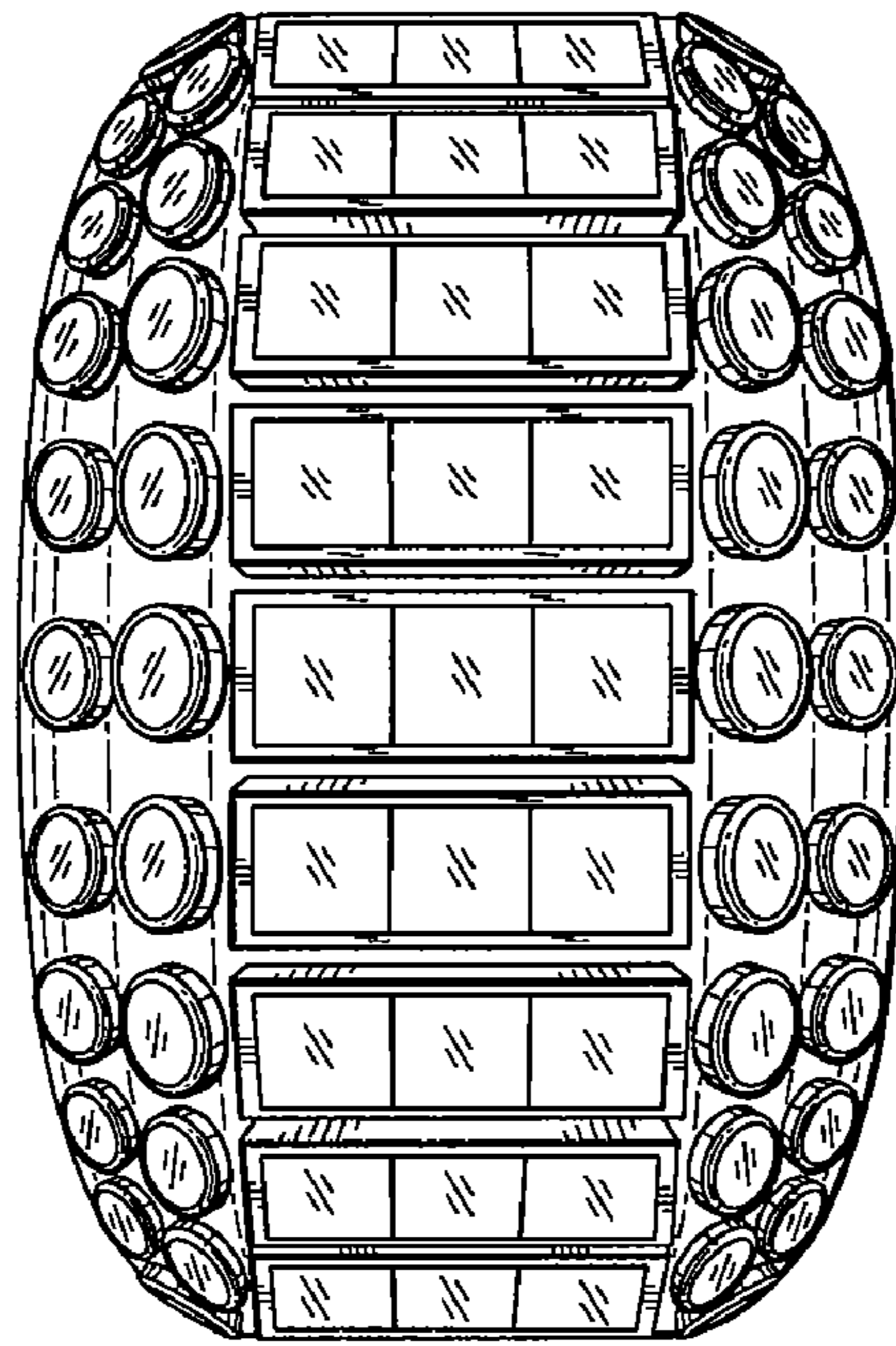

FIG. 2

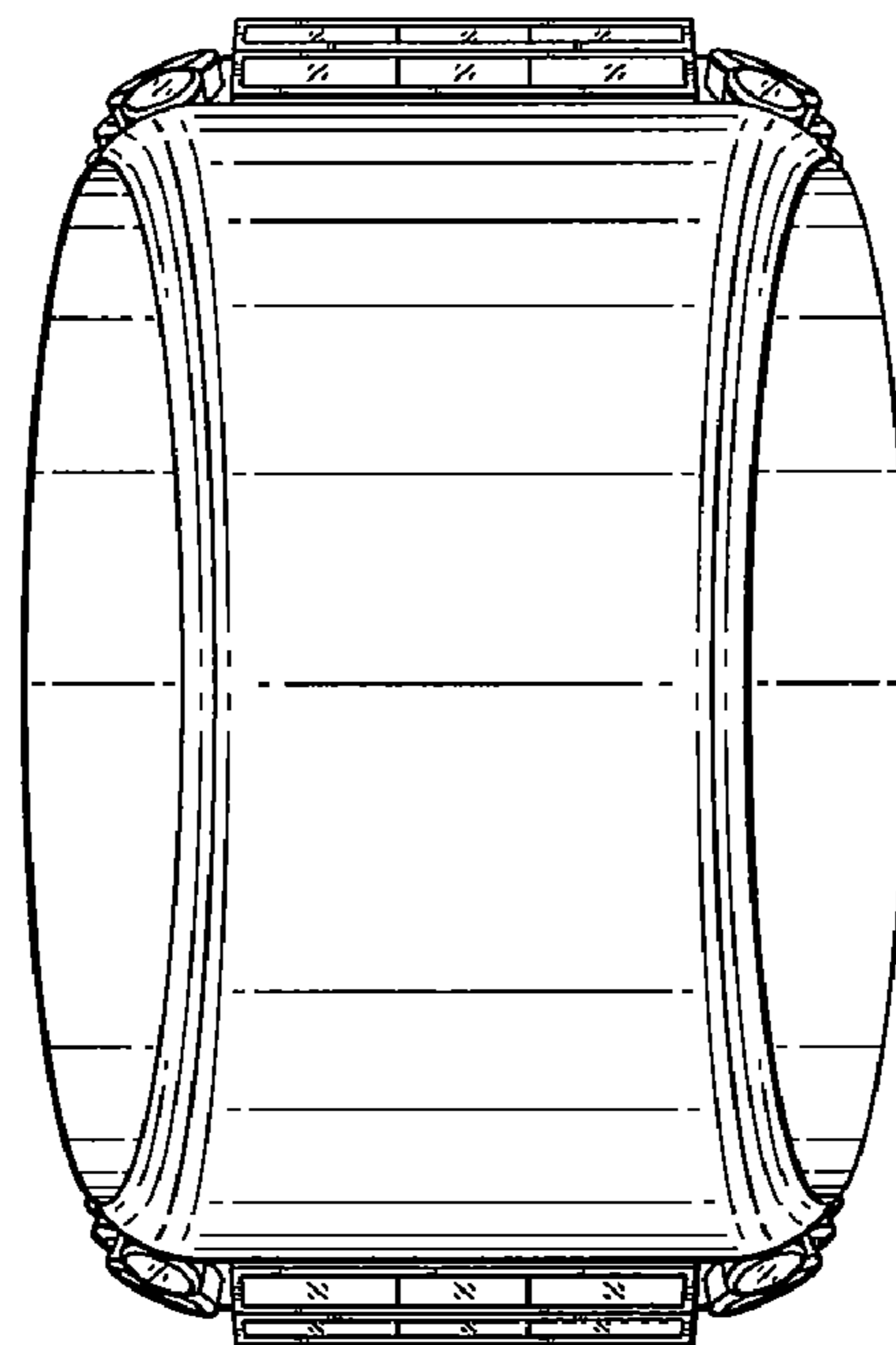

FIG. 3

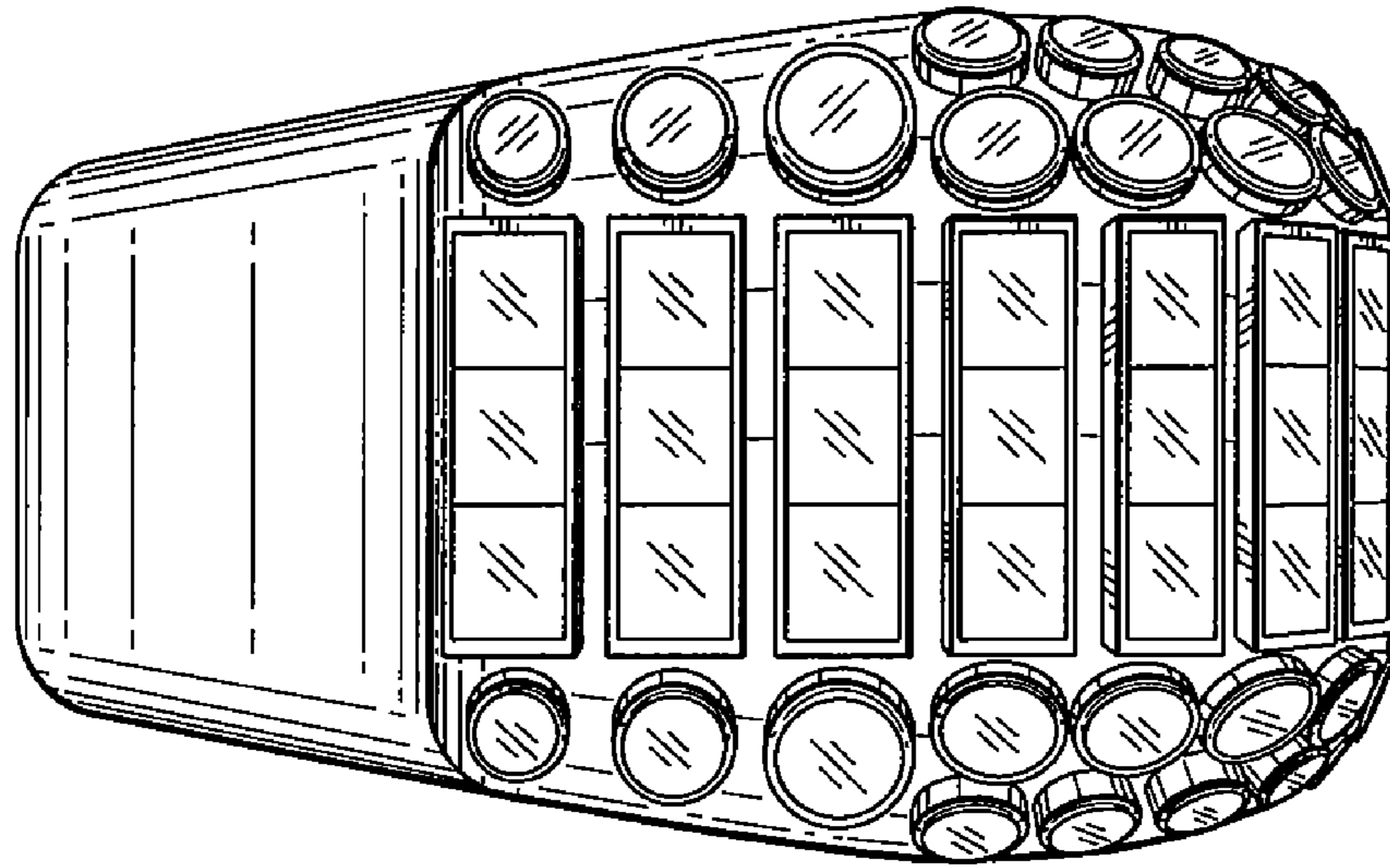

FIG. 4

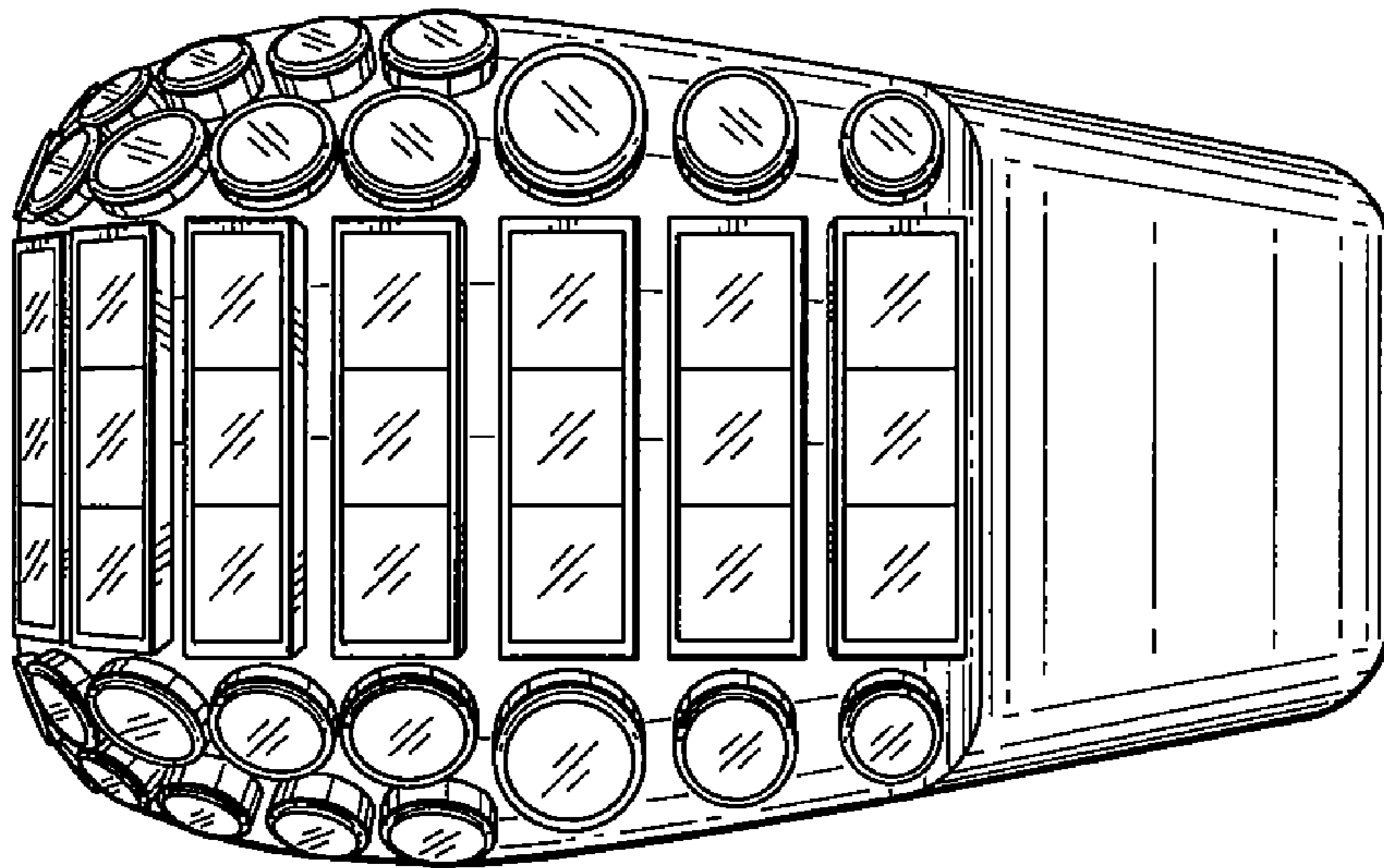

FIG. 5

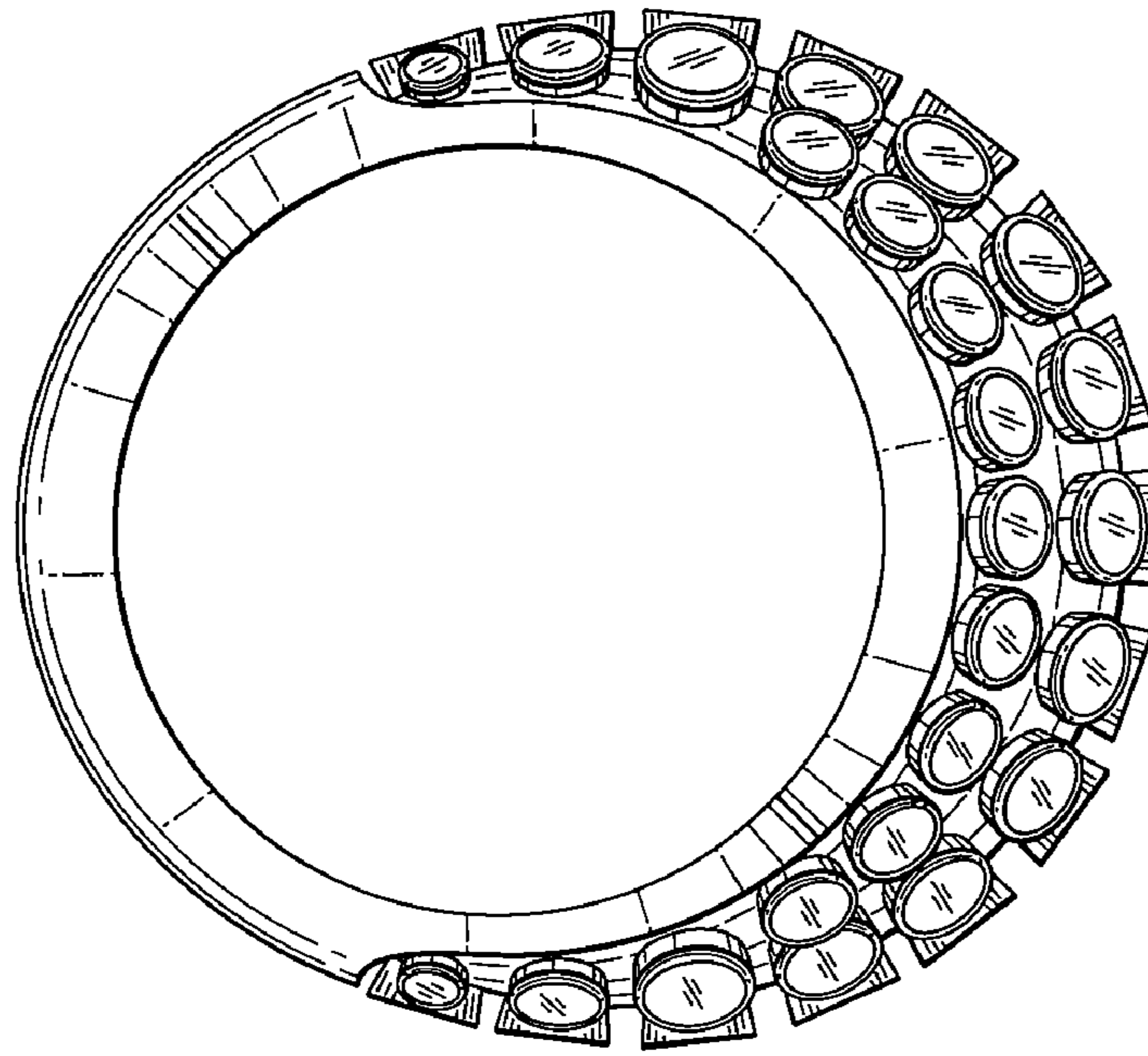

FIG. 6

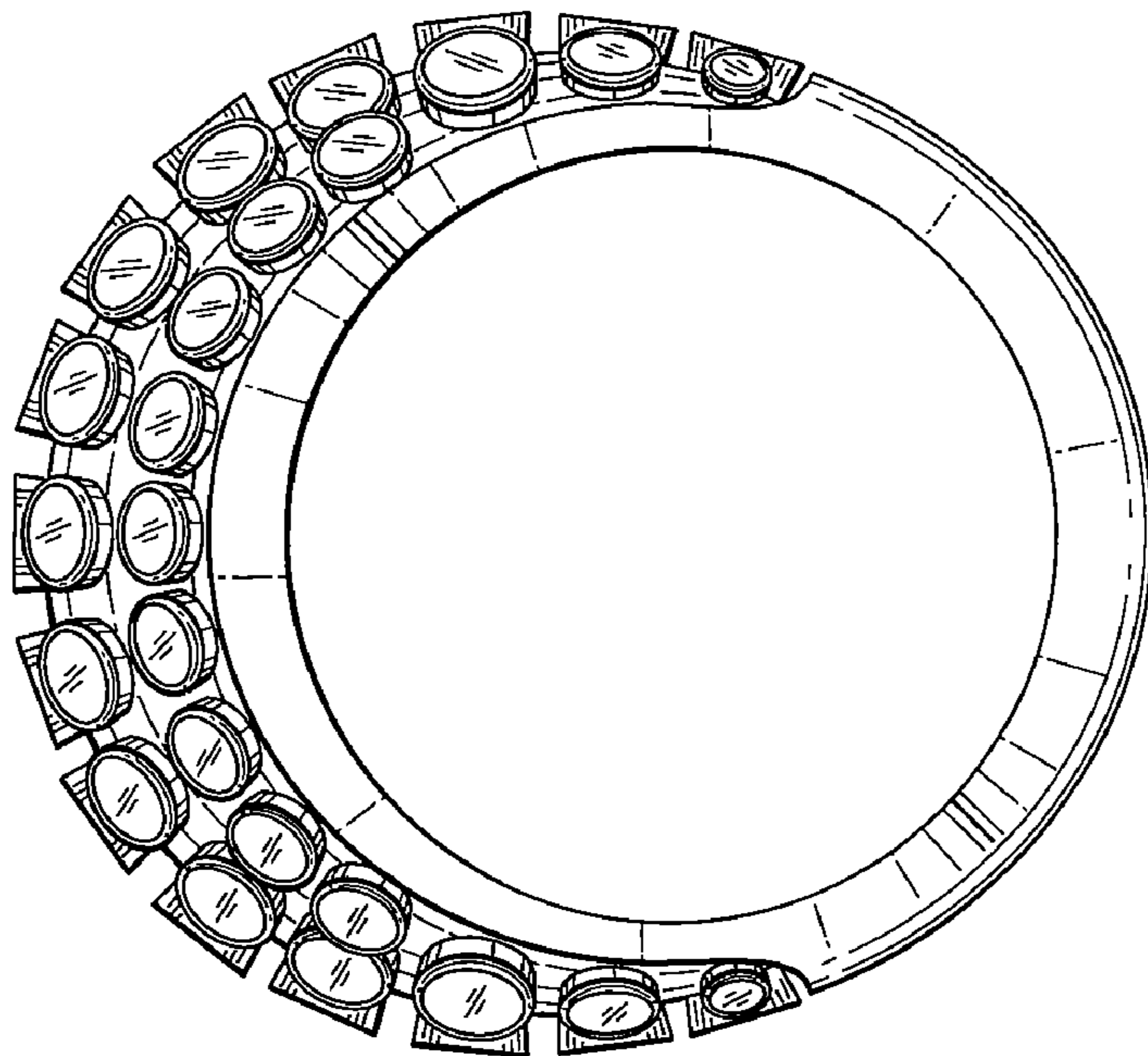

FIG. 7