



US00D561485S

(12) **United States Design Patent**
Hock

(10) **Patent No.:** **US D561,485 S**

(45) **Date of Patent:** **** Feb. 12, 2008**

(54) **CHAIR**

(76) Inventor: **Koh Tuang Hock**, 235 Chung-Ho Box
8-24, Taipei (TW)

(**) Term: **14 Years**

(21) Appl. No.: **29/288,310**

(22) Filed: **Jun. 7, 2007**

(51) **LOC (8) Cl.** **06-01**

(52) **U.S. Cl.** **D6/379**

(58) **Field of Classification Search** D6/334-336,
D6/364, 365, 366, 367, 369, 372-374, 376,
D6/379, 380, 500-502; 297/239, 445.1,
297/446.1, 452.46

See application file for complete search history.

(56) **References Cited**

U.S. PATENT DOCUMENTS

D477,471 S * 7/2003 Brooks D6/379
D485,084 S * 1/2004 Bales D6/379
D498,072 S * 11/2004 Barile et al. D6/380

D505,801 S * 6/2005 Cesaroni et al. D6/379
D513,457 S * 1/2006 Asano et al. D6/380
D541,067 S * 4/2007 Lin D6/380

* cited by examiner

Primary Examiner—Mimosa De

(57) **CLAIM**

The ornamental design for a chair, as shown and described.

DESCRIPTION

FIG. 1 is a perspective view of a chair showing my new design.

FIG. 2 is a front elevational view thereof.

FIG. 3 is a rear elevational view thereof.

FIG. 4 is a left side view thereof;

FIG. 5 is a right side view thereof.

FIG. 6 is a top plan view thereof; and,

FIG. 7 is a bottom plan view thereof.

1 Claim, 7 Drawing Sheets

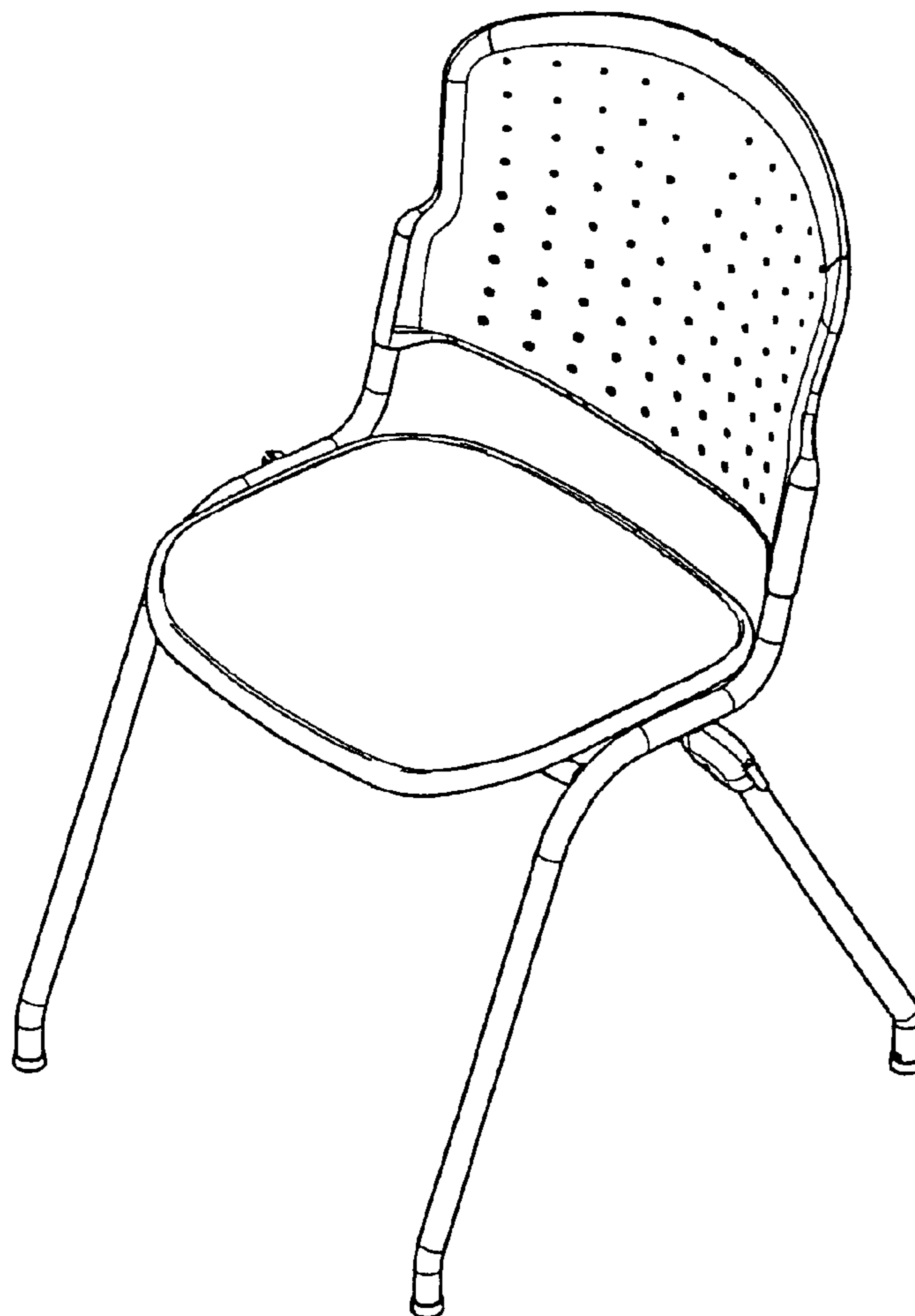

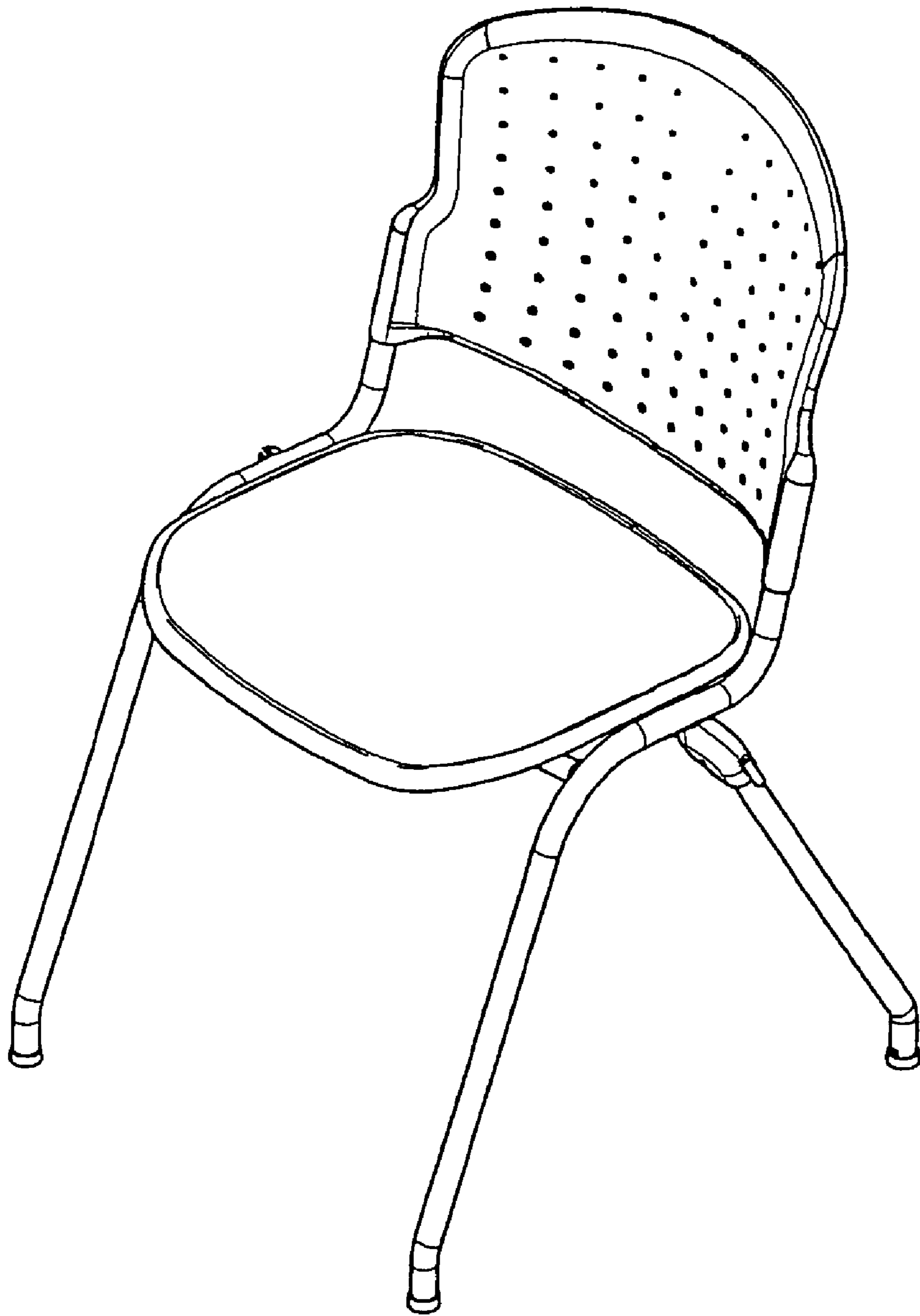

FIG. 1

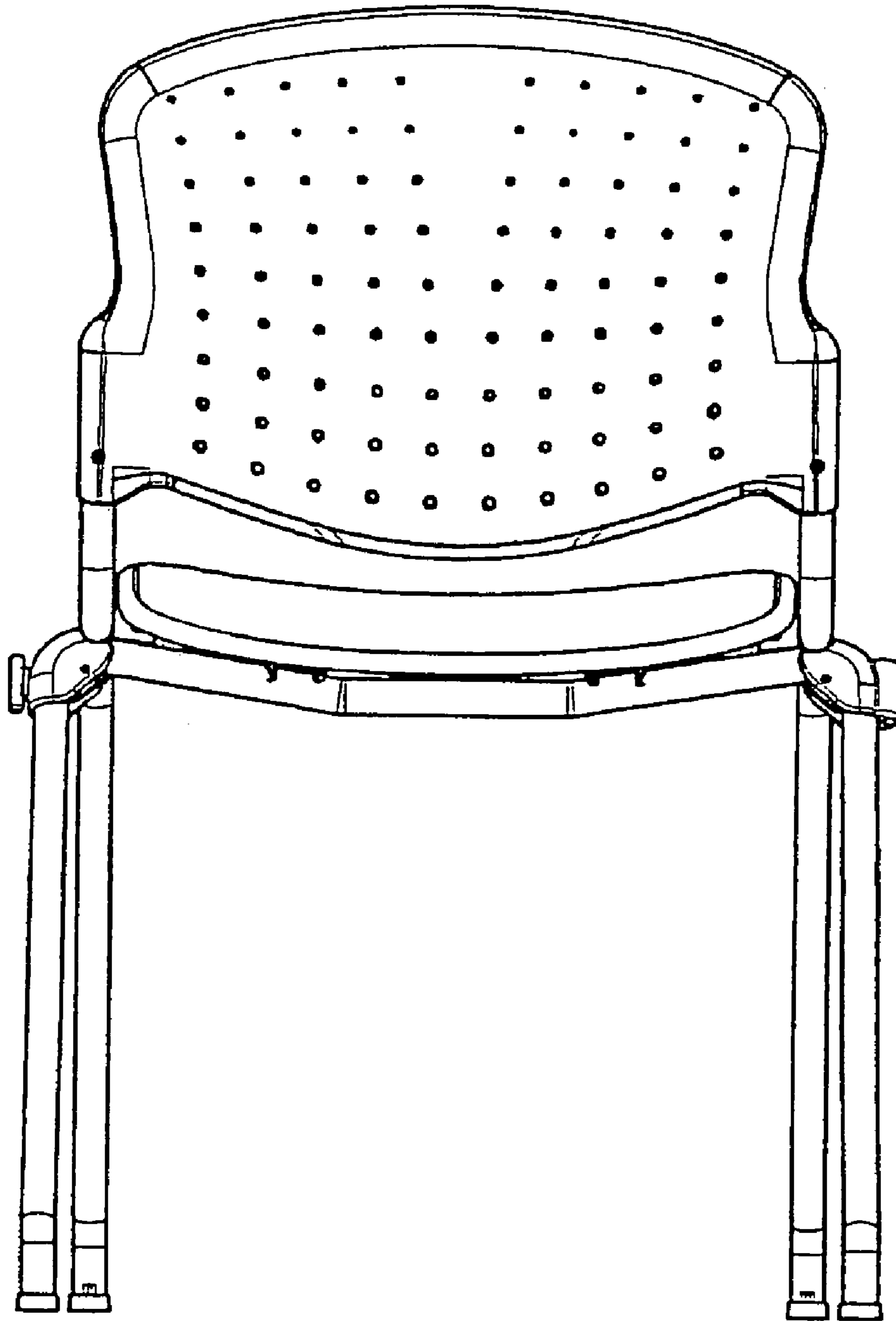

FIG. 2

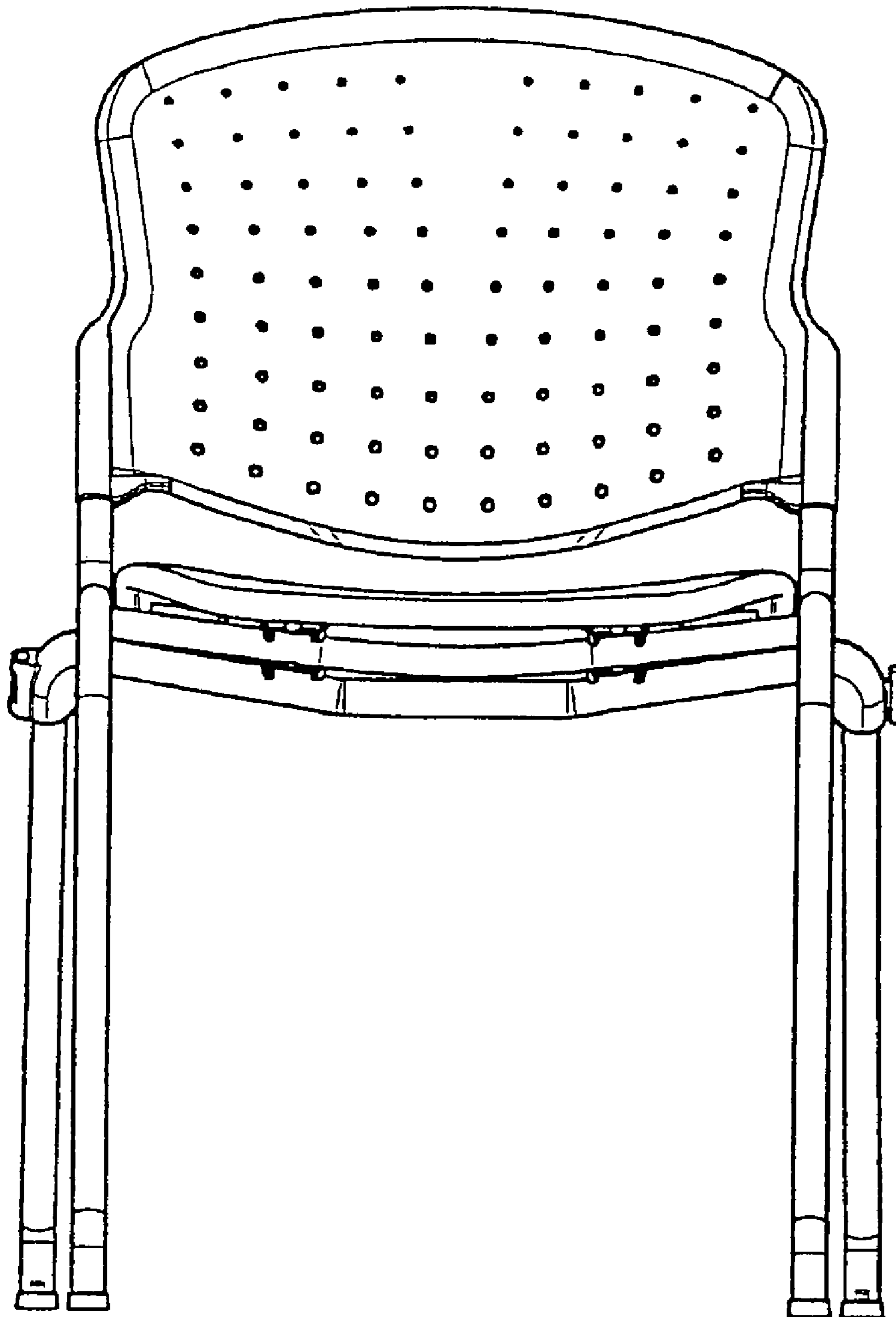

FIG. 3

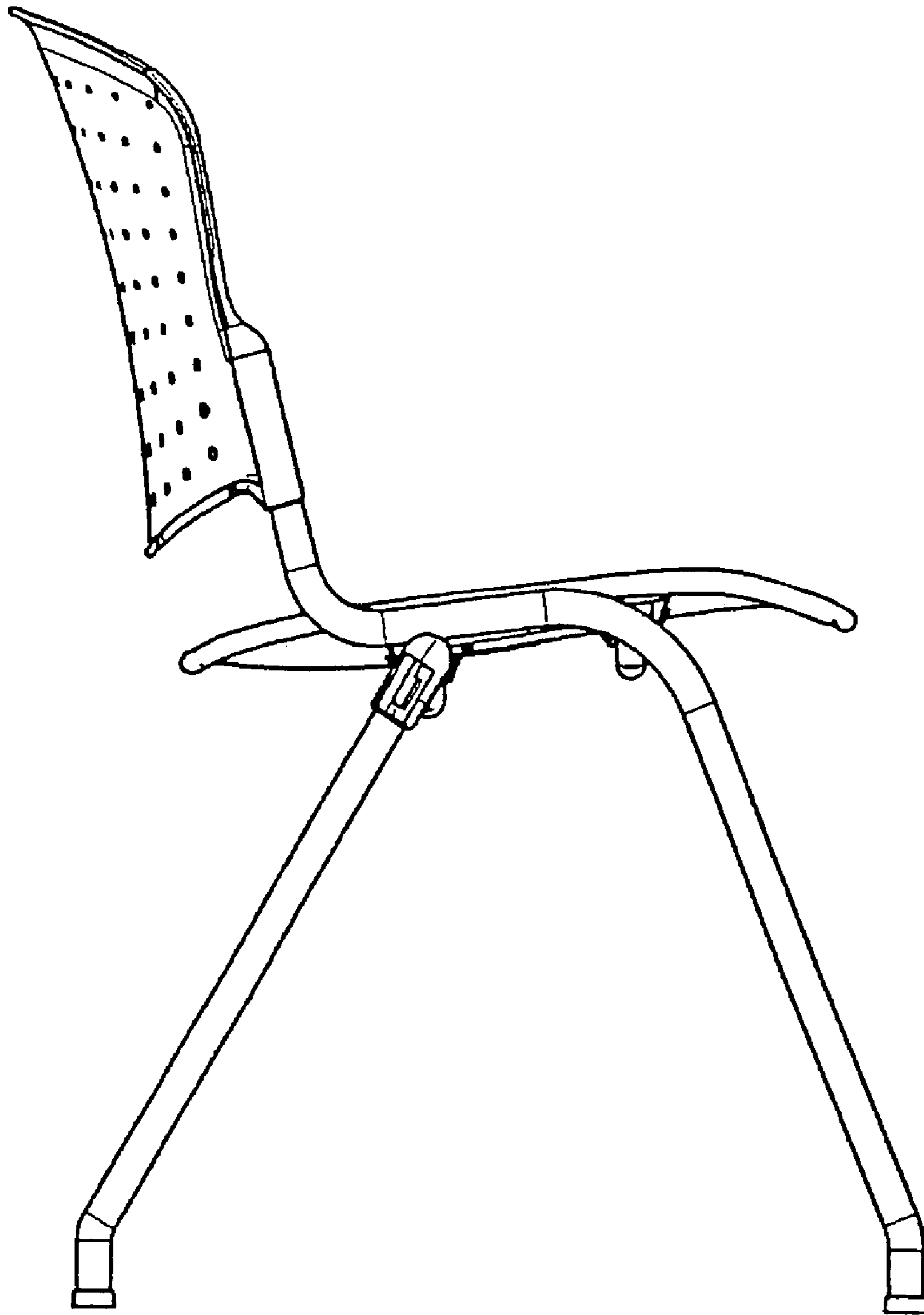

FIG. 4

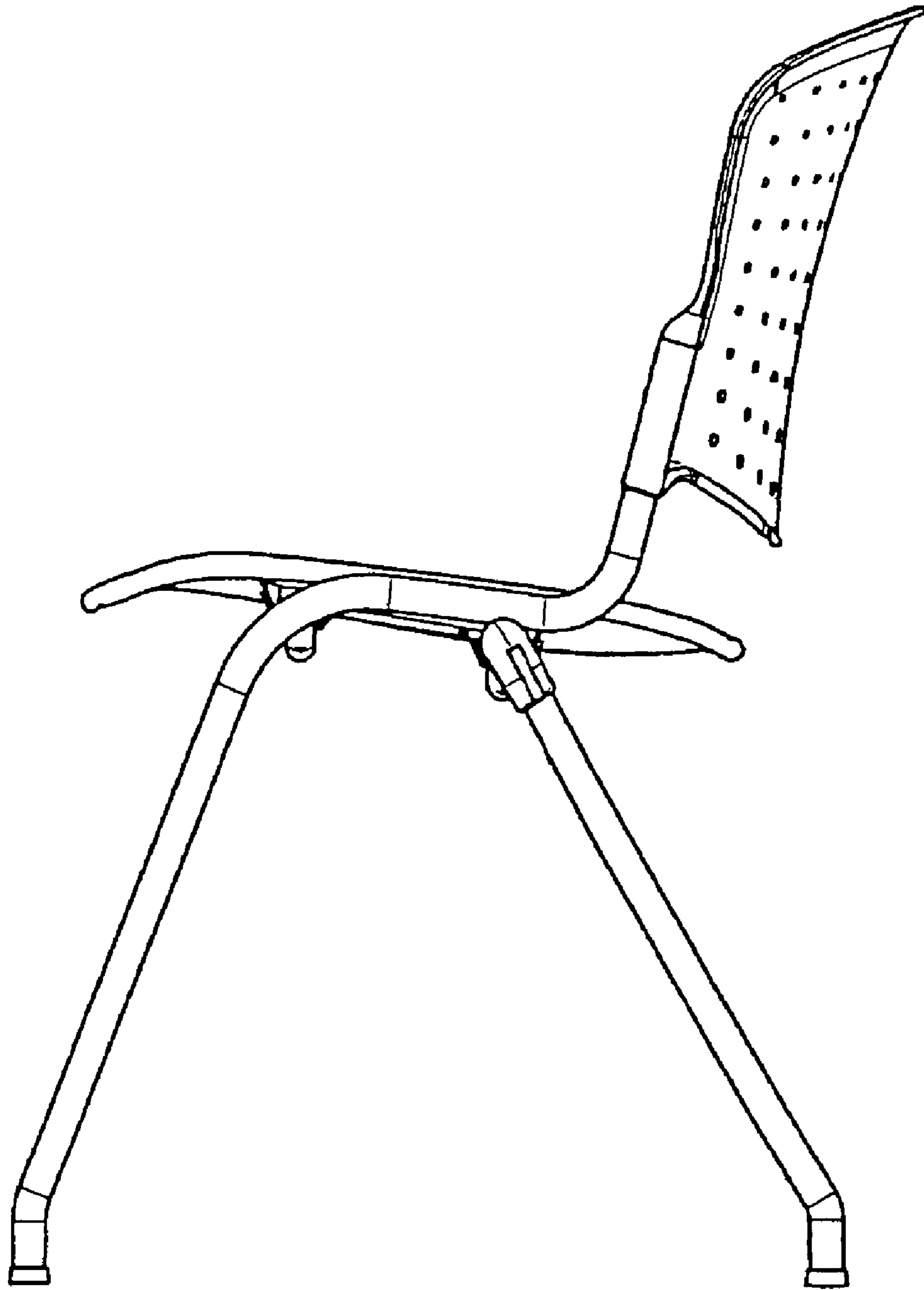

FIG. 5

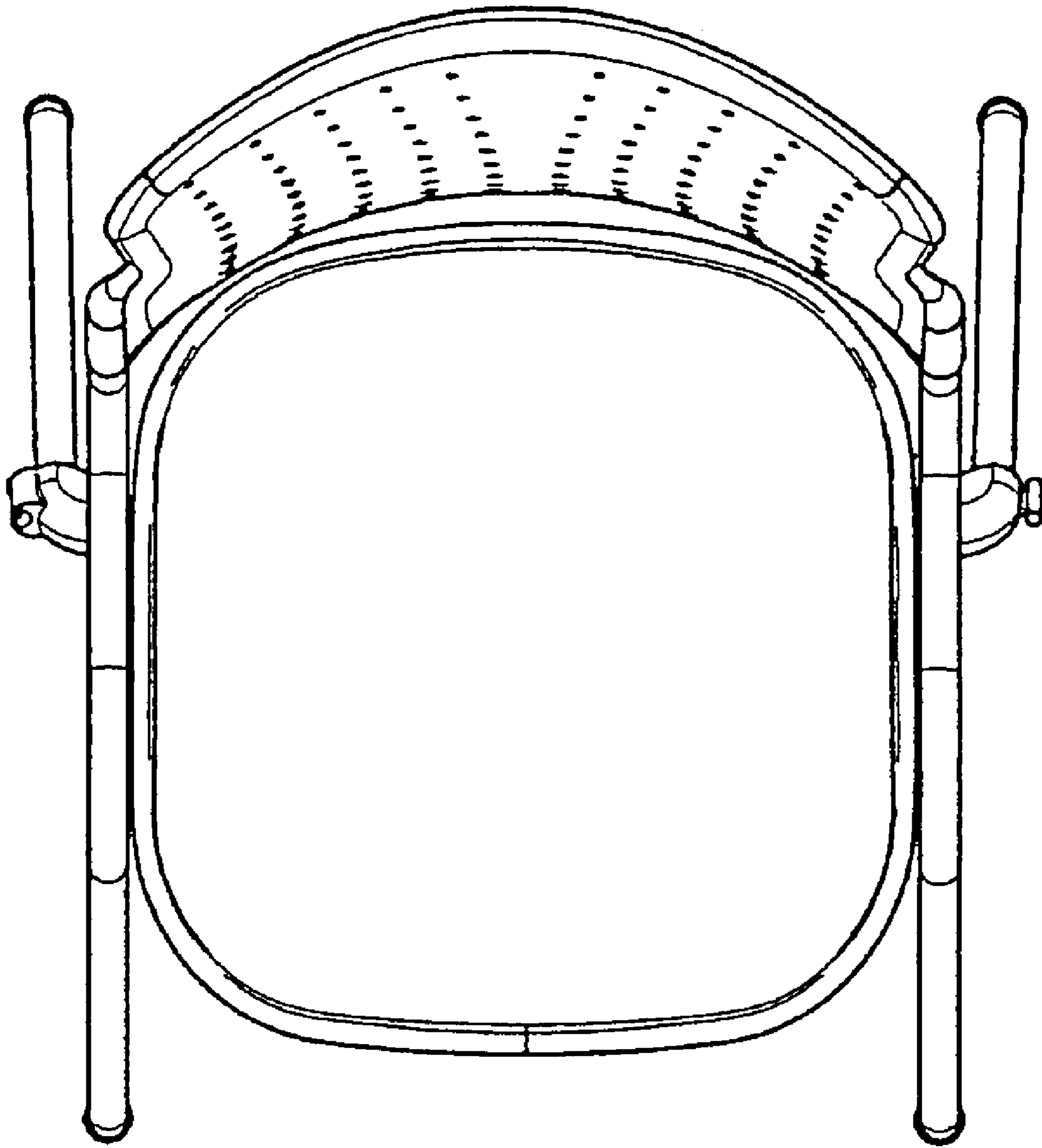

FIG. 6

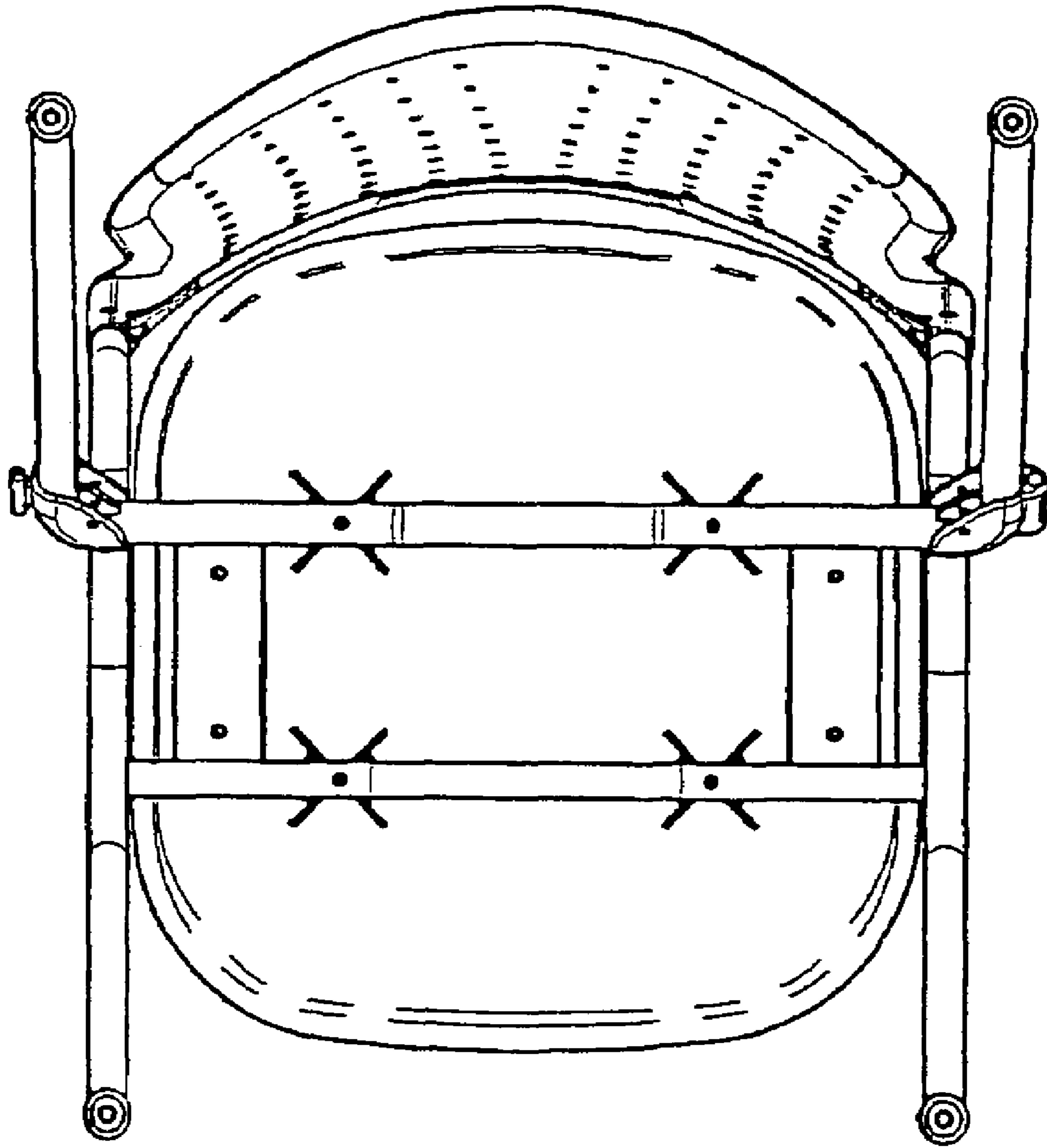

FIG. 7