



US00D561474S

(12) **United States Design Patent**
Nakamura

(10) **Patent No.:** **US D561,474 S**
(45) **Date of Patent:** **** Feb. 12, 2008**

(54) **CASE FOR ELECTRONIC DEVICE**

(75) Inventor: **Takatoshi Nakamura**, Tokyo (JP)
(73) Assignee: **Sony Computer Entertainment Inc.**,
Tokyo (JP)

(**) Term: **14 Years**

(21) Appl. No.: **29/268,484**

(22) Filed: **Nov. 8, 2006**

(30) **Foreign Application Priority Data**

May 8, 2006 (JP) 2006-011634

(51) **LOC (8) Cl.** **03-01**

(52) **U.S. Cl.** **D3/318**

(58) **Field of Classification Search** D3/201,
D3/203.1, 203.6, 205, 273, 294–295, 318,
D3/903, 905; D9/414, 422, 424, 430, 432,
D9/434; D14/356, 432, 435–436; D21/333;
D27/183, 186.7, 189; 206/216, 307, 307.1,
206/308.2, 387.1, 387.11

See application file for complete search history.

(56) **References Cited**

U.S. PATENT DOCUMENTS

D168,287 S * 12/1952 Burgess D3/294
D258,705 S * 3/1981 Wheeler D3/295
4,271,961 A * 6/1981 Blankenmeister 206/216
4,469,225 A * 9/1984 Takahashi 206/387.1
4,913,287 A * 4/1990 Kagano 206/387.1

* cited by examiner

Primary Examiner—Philip S. Hyder

Assistant Examiner—RoseLynne (Ulm) Cody

(74) *Attorney, Agent, or Firm*—Rader, Fishman & Grauer,
PLLC

(57) **CLAIM**

The ornamental design for a case for electronic device, as shown and described.

DESCRIPTION

FIG. 1 is a front elevational view of a case for electronic device showing my new design;

FIG. 2 is a right side elevational view thereof, a left side elevational view thereof being a mirror image;

FIG. 3 is a top, right perspective view thereof;

FIG. 4 is a bottom, left perspective view thereof;

FIG. 5 is a cross-sectional view thereof taken along the line V—V shown in FIG. 1; and

FIG. 6 is a cross-sectional view thereof taken along the line VI—VI shown in FIG. 1.

FIG. 7 is a rear elevational view thereof;

FIG. 8 is a top plan view thereof;

FIG. 9 is a bottom plan view thereof;

FIG. 10 is a reference front elevational view thereof in a closed state;

FIG. 11 is a reference right side elevational view thereof in a closed state, a reference left side elevational view thereof being a mirror image;

FIG. 12 is a reference top plan view thereof in a closed state;

FIG. 13 is a reference bottom plan view thereof in a closed state; and,

FIG. 14 is a reference top, right perspective view thereof in a closed state.

The broken lines shown in all figures are illustrative of environment and form no part of the claimed design.

1 Claim, 14 Drawing Sheets

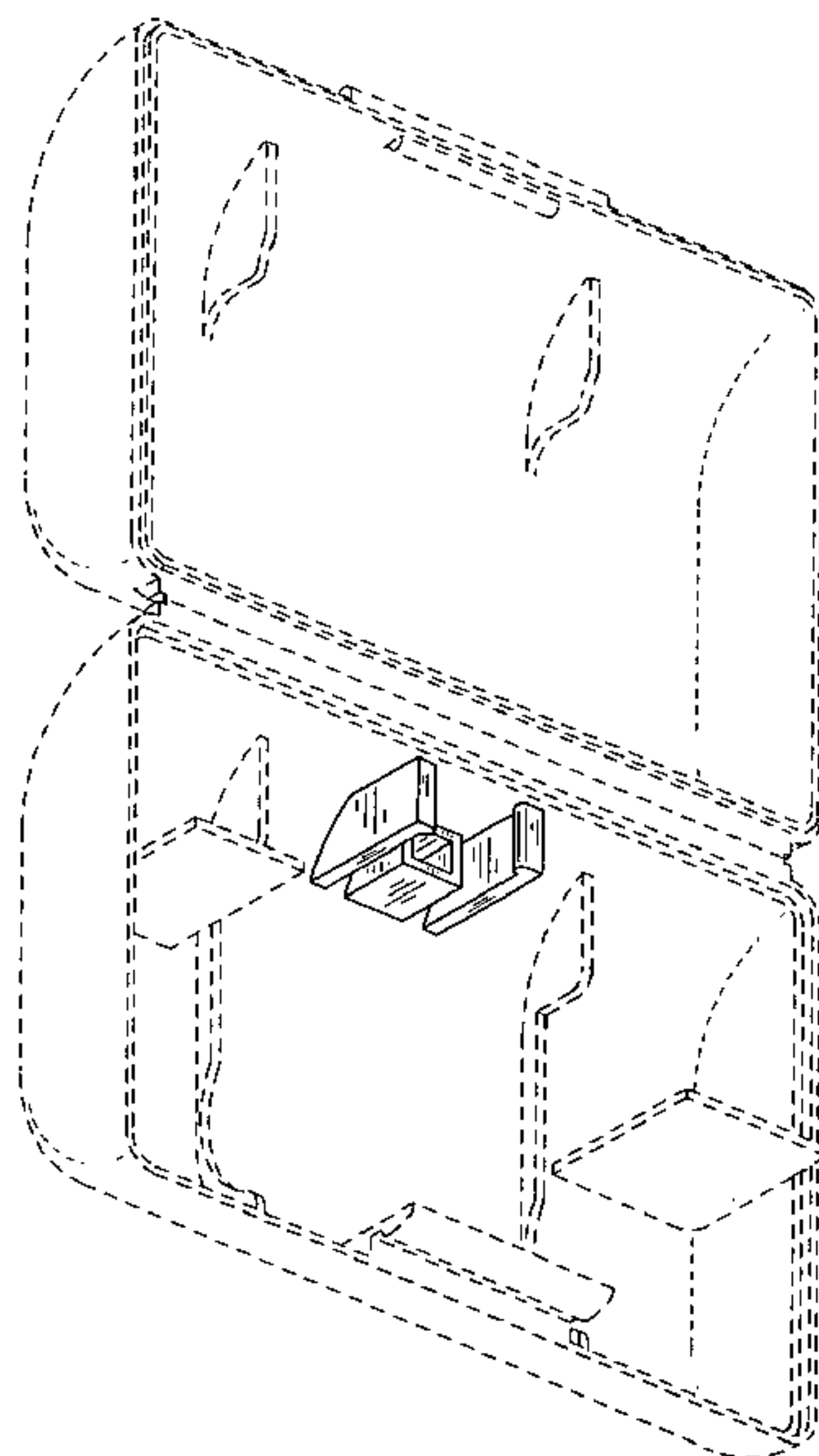

Fig. 1

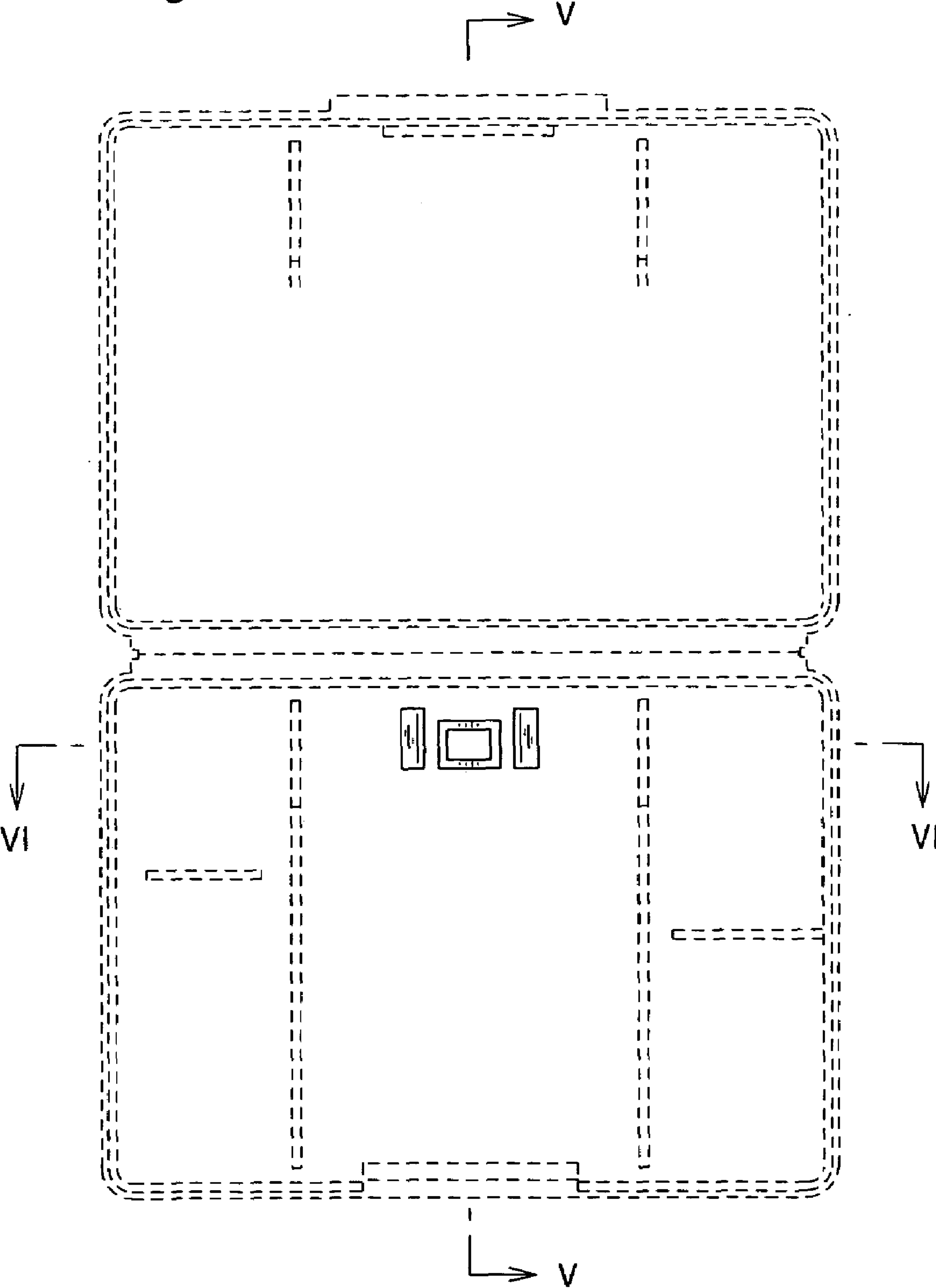

Fig.2

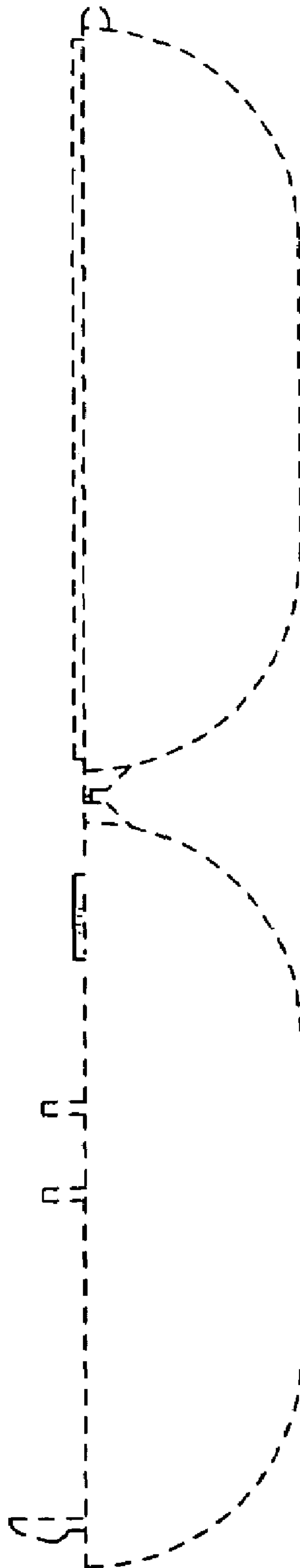

Fig.3

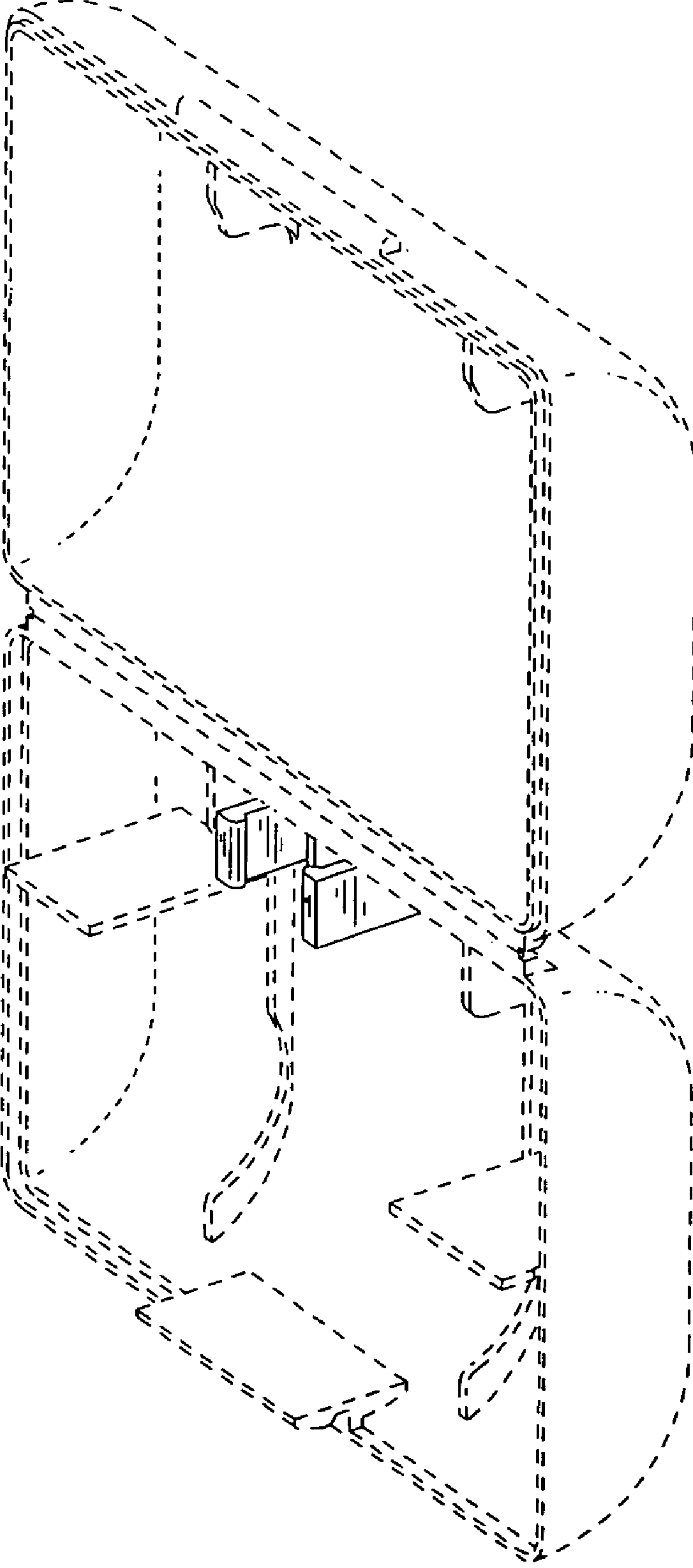

Fig.4

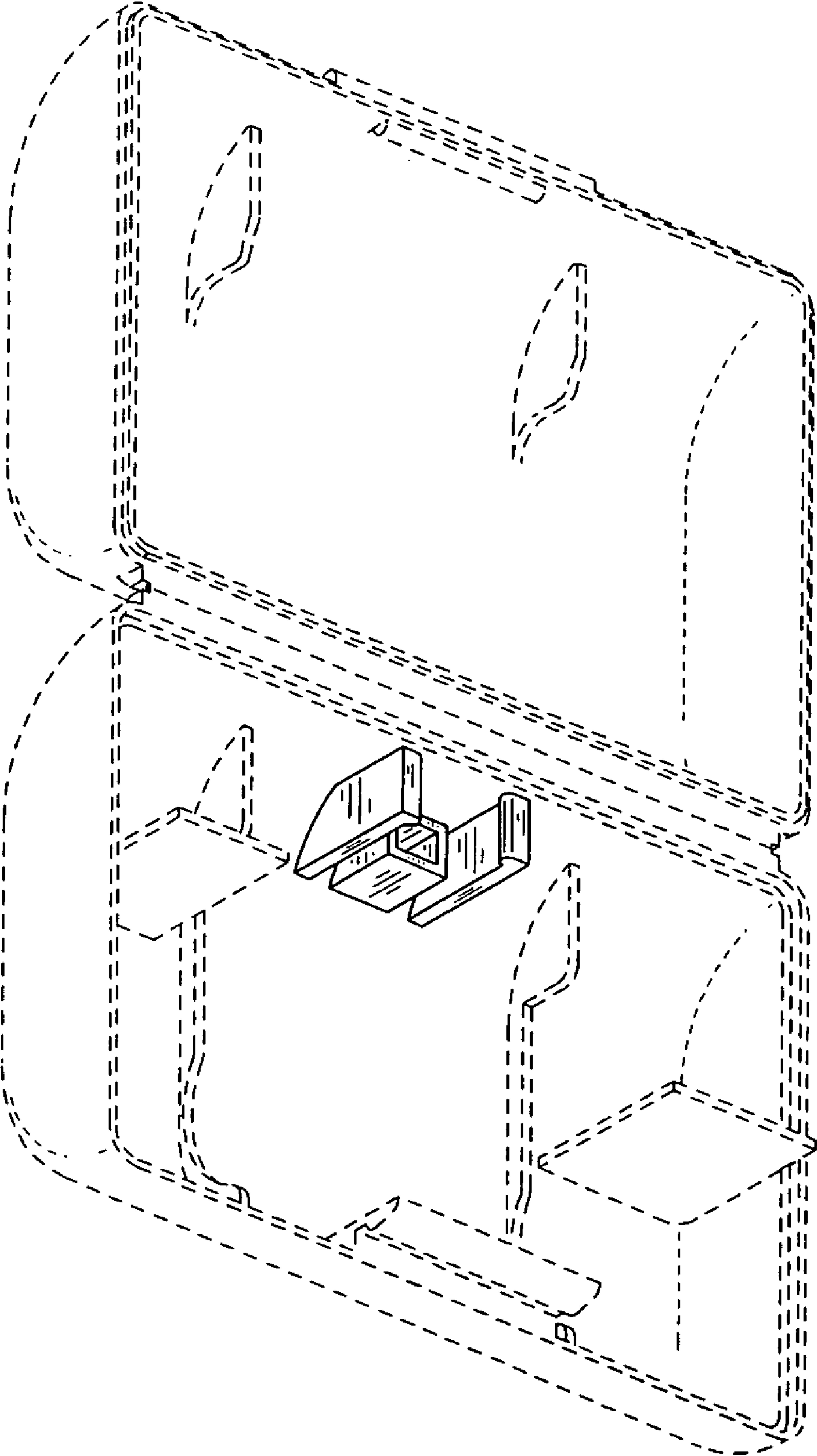

Fig.5

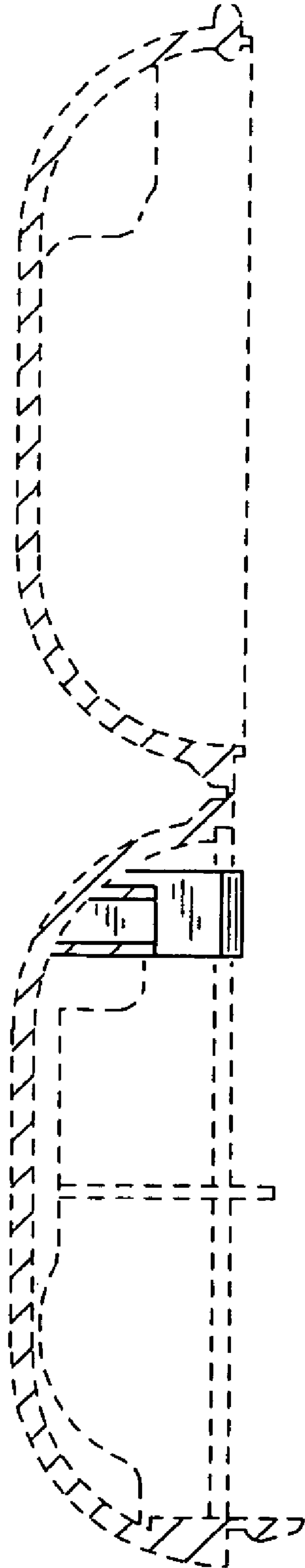

Fig.6

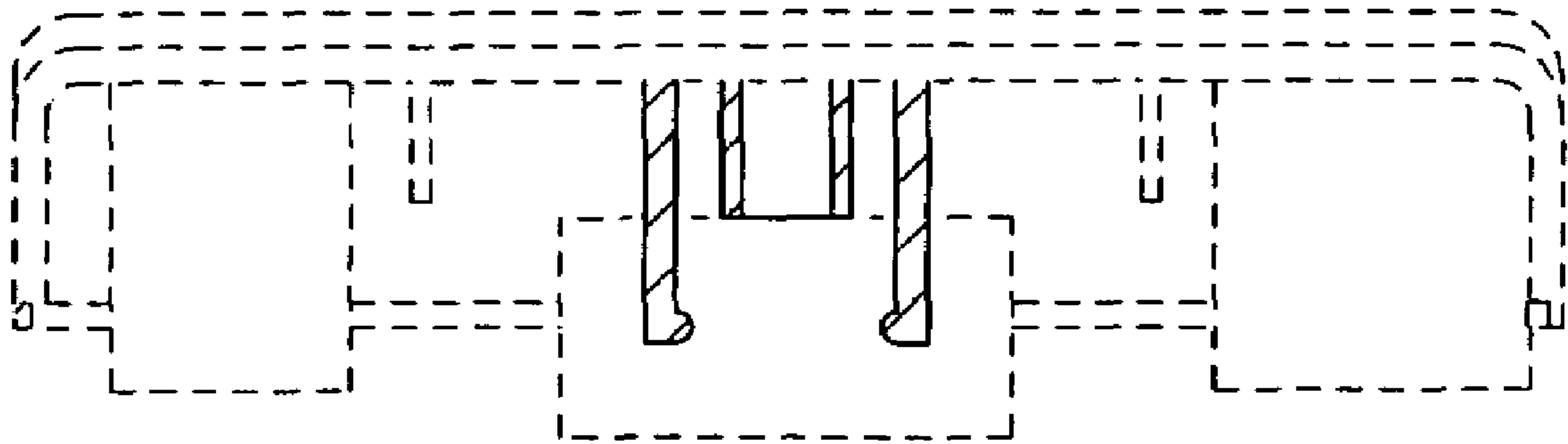

Fig.7

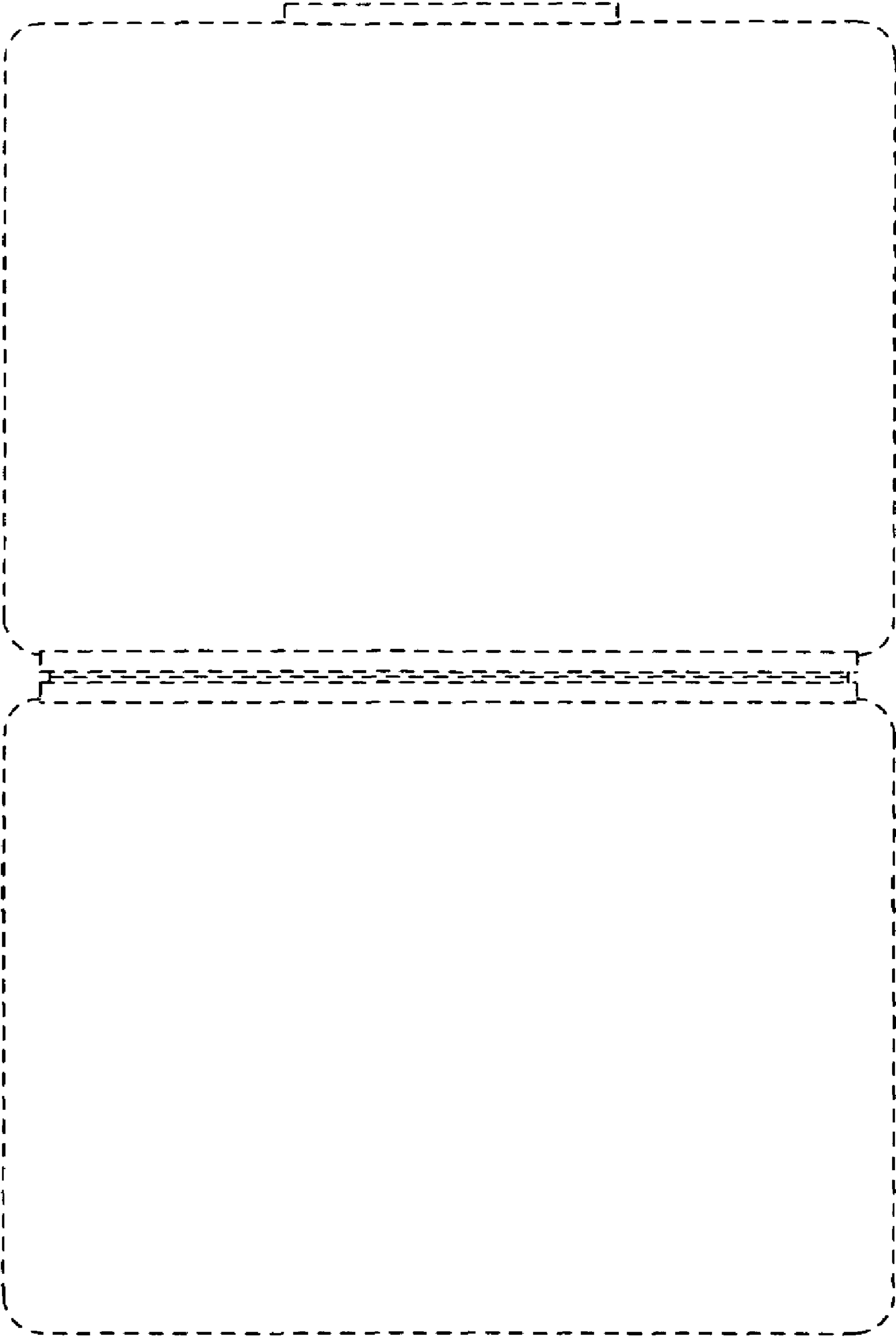

Fig.8

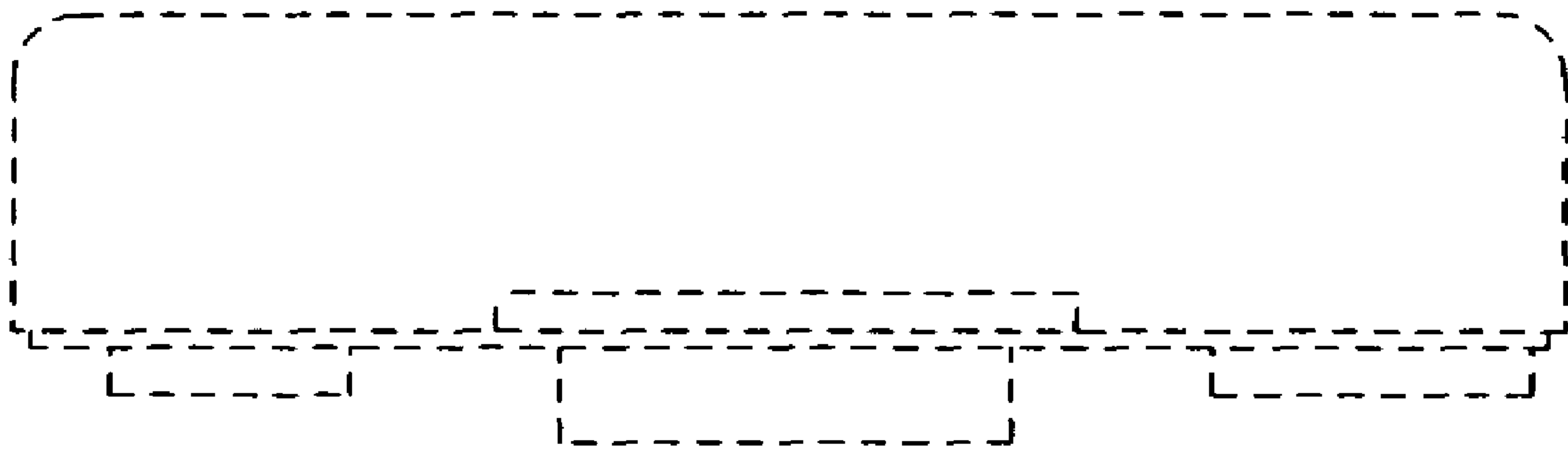

Fig.9

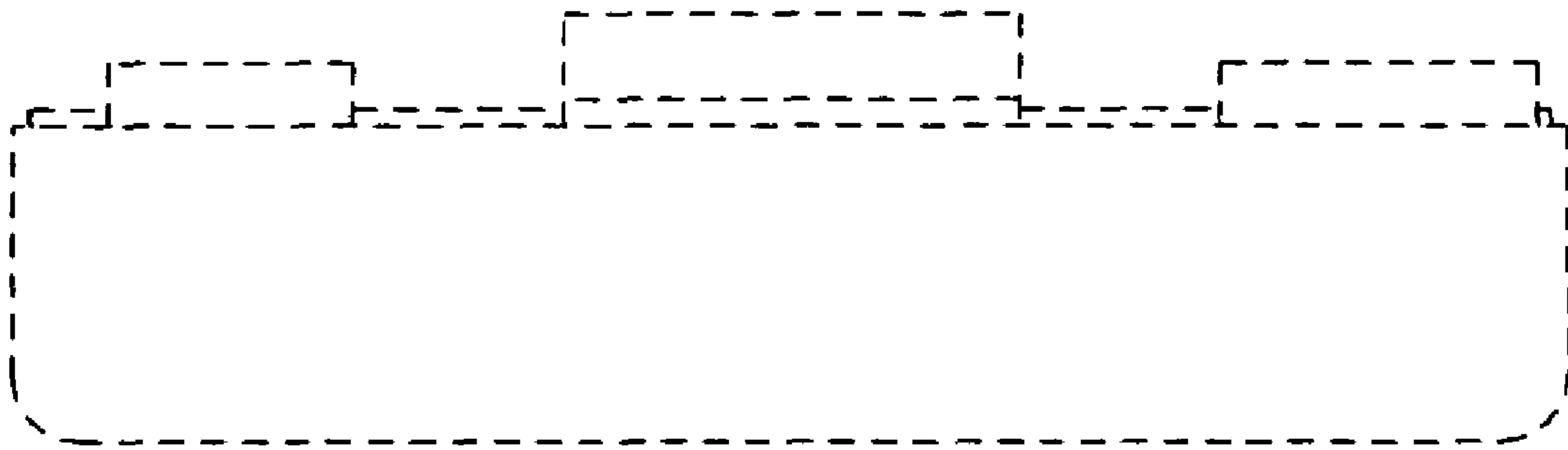

Fig.10

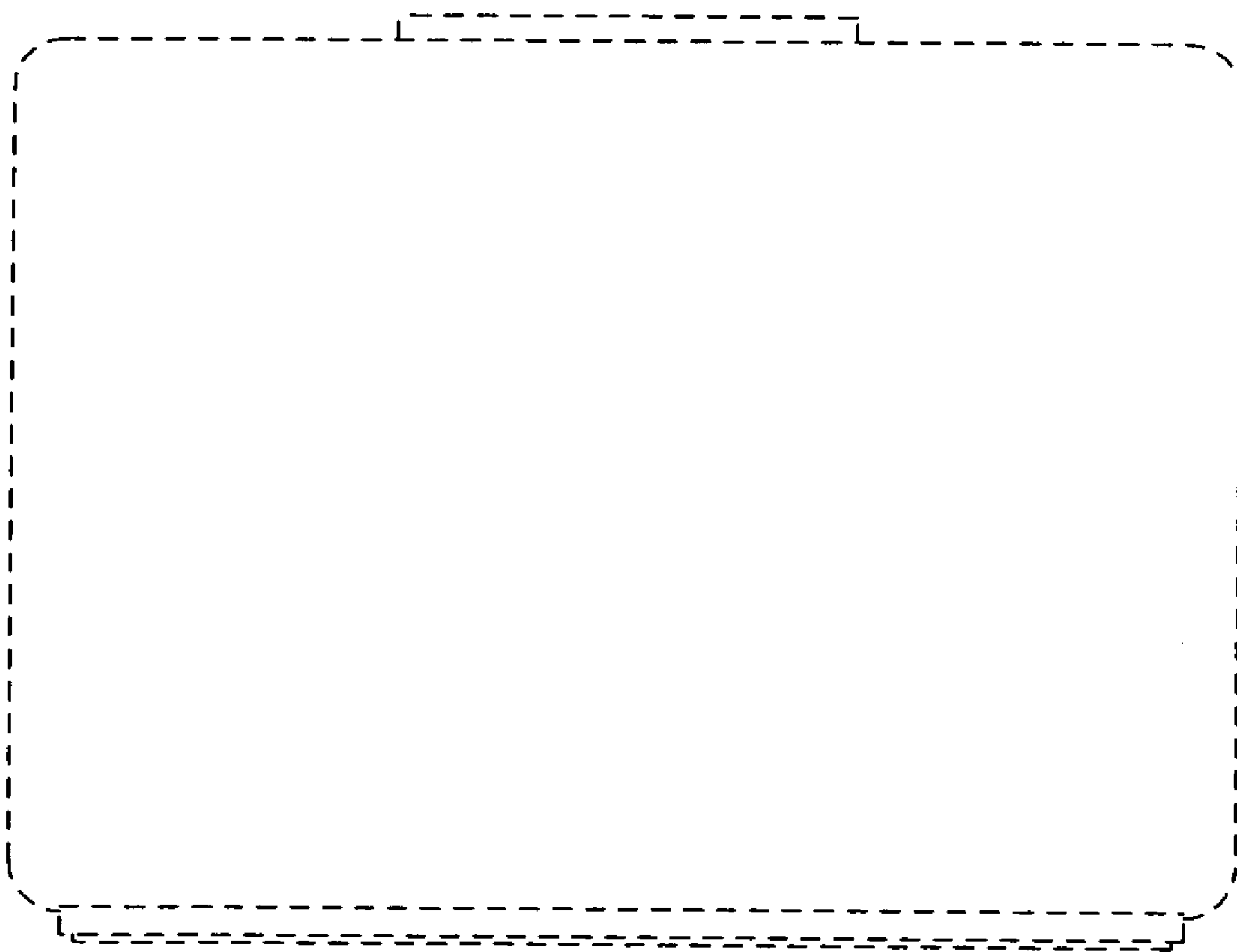

Fig. 11

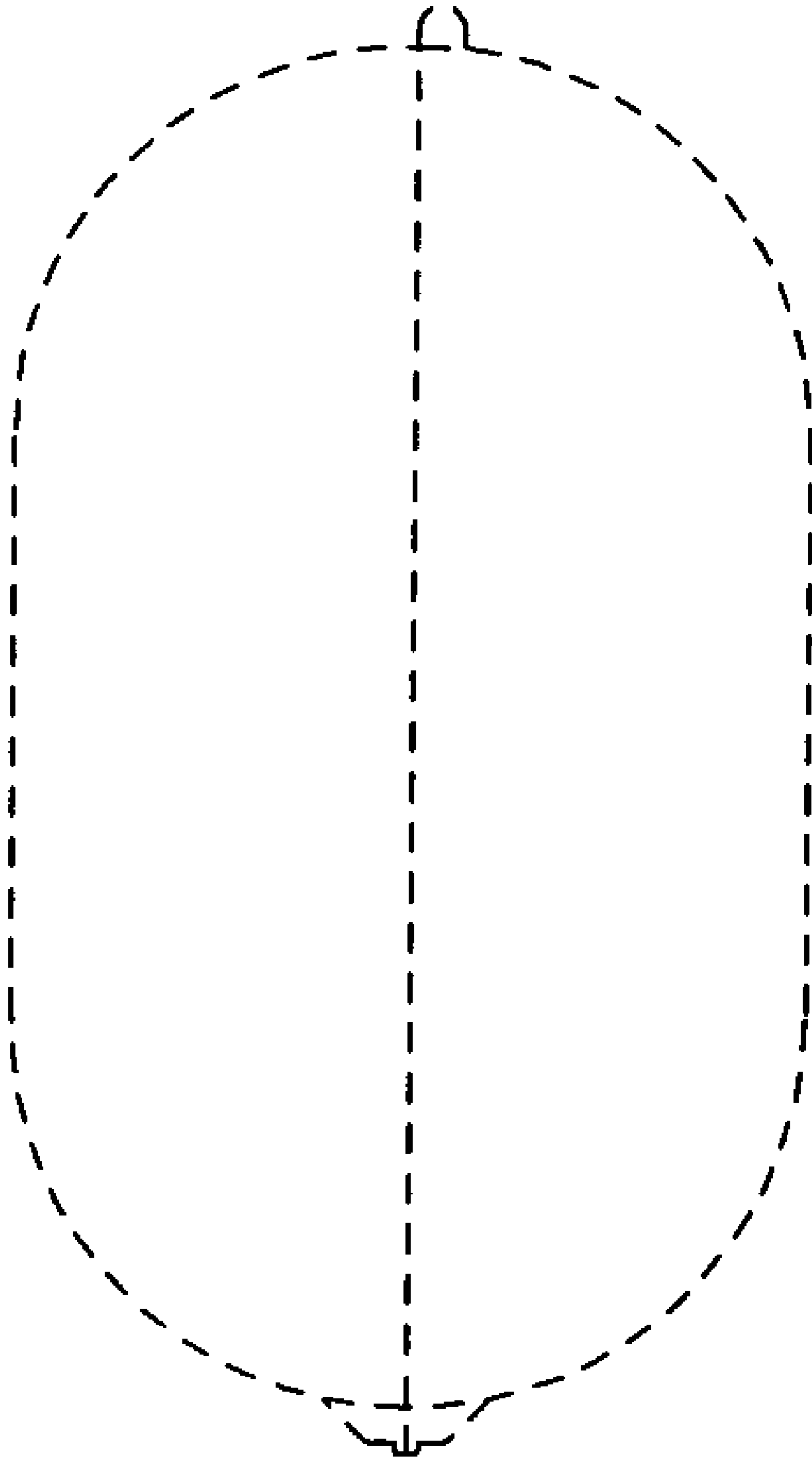

Fig. 12

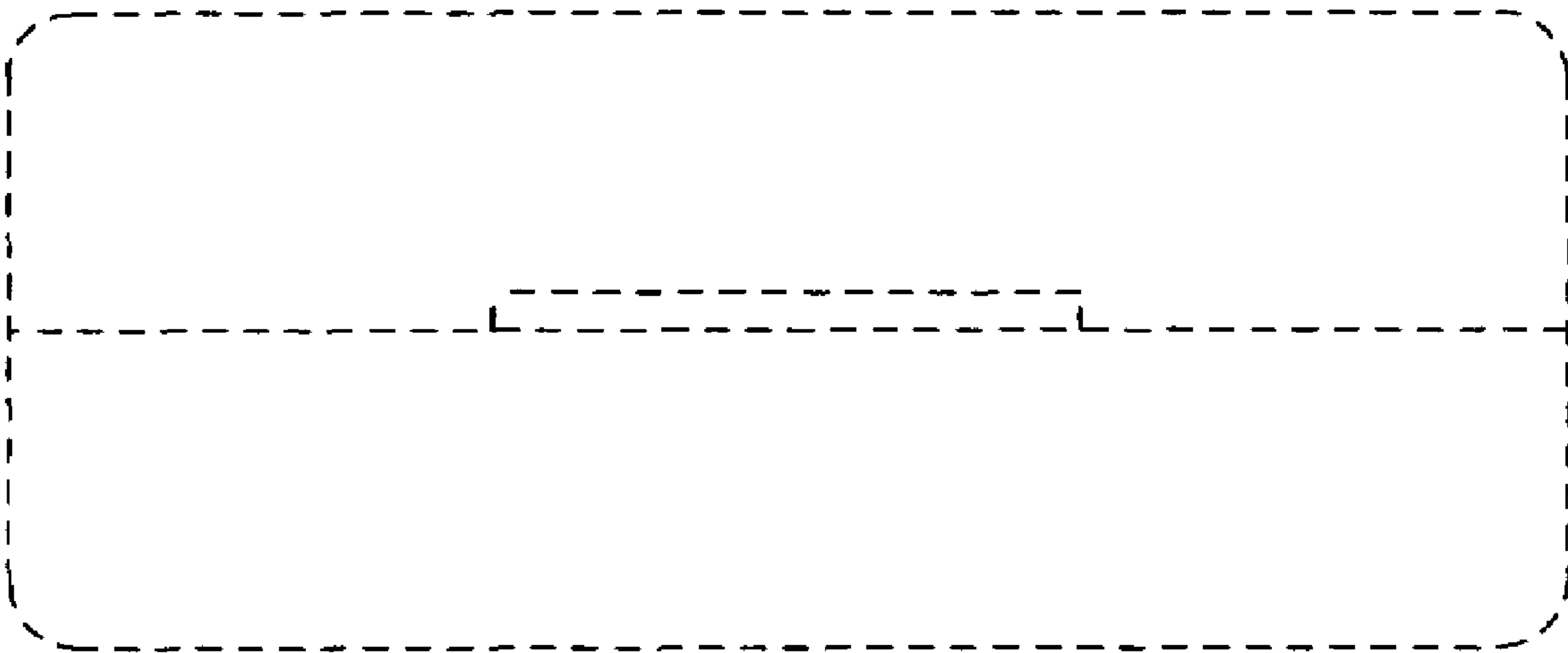

Fig.13

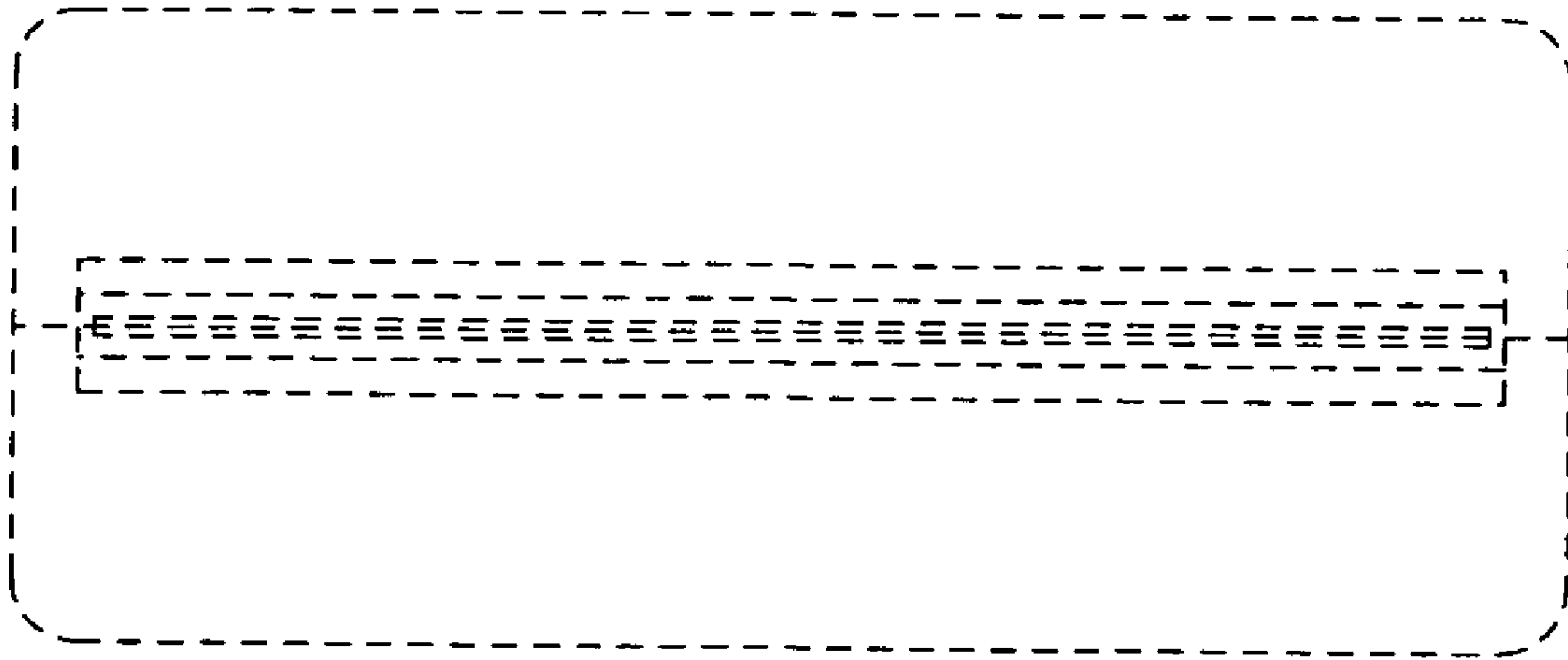

Fig. 14

