



US00D561366S

(12) **United States Design Patent**
Wang

(10) **Patent No.:** **US D561,366 S**

(45) **Date of Patent:** **** Feb. 5, 2008**

(54) **HAND-OPERATED FLASHLIGHT**

D547,890 S * 7/2007 Lee D26/37

(76) Inventor: **Hsiao-Chun Wang**, 3F., No. 26, Lane
81, Wunhu St., Neihu District, Taipei
City 11445 (TW)

* cited by examiner

Primary Examiner—Marcus A. Jackson
(74) *Attorney, Agent, or Firm*—Banger Shia

(**) Term: **14 Years**

(57) **CLAIM**

(21) Appl. No.: **29/281,856**

The ornamental design for a hand-operated flashlight, as shown and described.

(22) Filed: **Jul. 3, 2007**

(51) **LOC (8) Cl.** **26-02**

(52) **U.S. Cl.** **D26/37**

(58) **Field of Classification Search** D26/37-50;
362/157, 158, 171-174, 183-208
See application file for complete search history.

DESCRIPTION

FIG. 1 is a perspective view of a hand-operated flashlight showing my new design;

FIG. 2 is a front elevational view thereof;

FIG. 3 is a rear elevational view thereof;

FIG. 4 is a left side elevational view thereof;

FIG. 5 is a right side elevational view thereof;

FIG. 6 is a top plan view thereof; and,

FIG. 7 is a bottom plan view to that shown.

(56) **References Cited**

U.S. PATENT DOCUMENTS

- D511,586 S * 11/2005 Yeh D26/37
- D520,160 S * 5/2006 Lee D26/37
- D544,616 S * 6/2007 Chen D26/37
- D544,975 S * 6/2007 Lee D26/37
- D546,990 S * 7/2007 Wang et al. D26/37

1 Claim, 4 Drawing Sheets

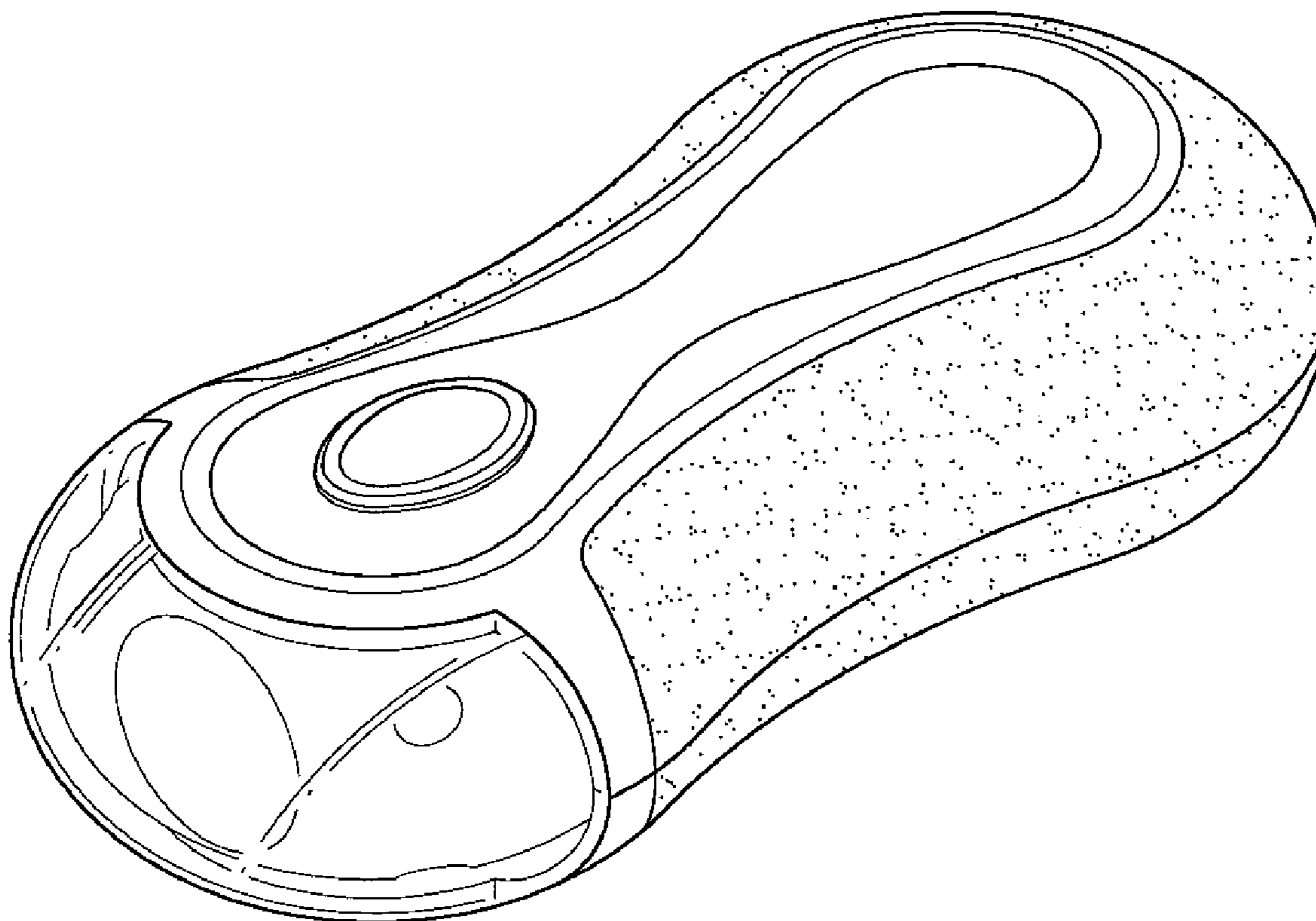

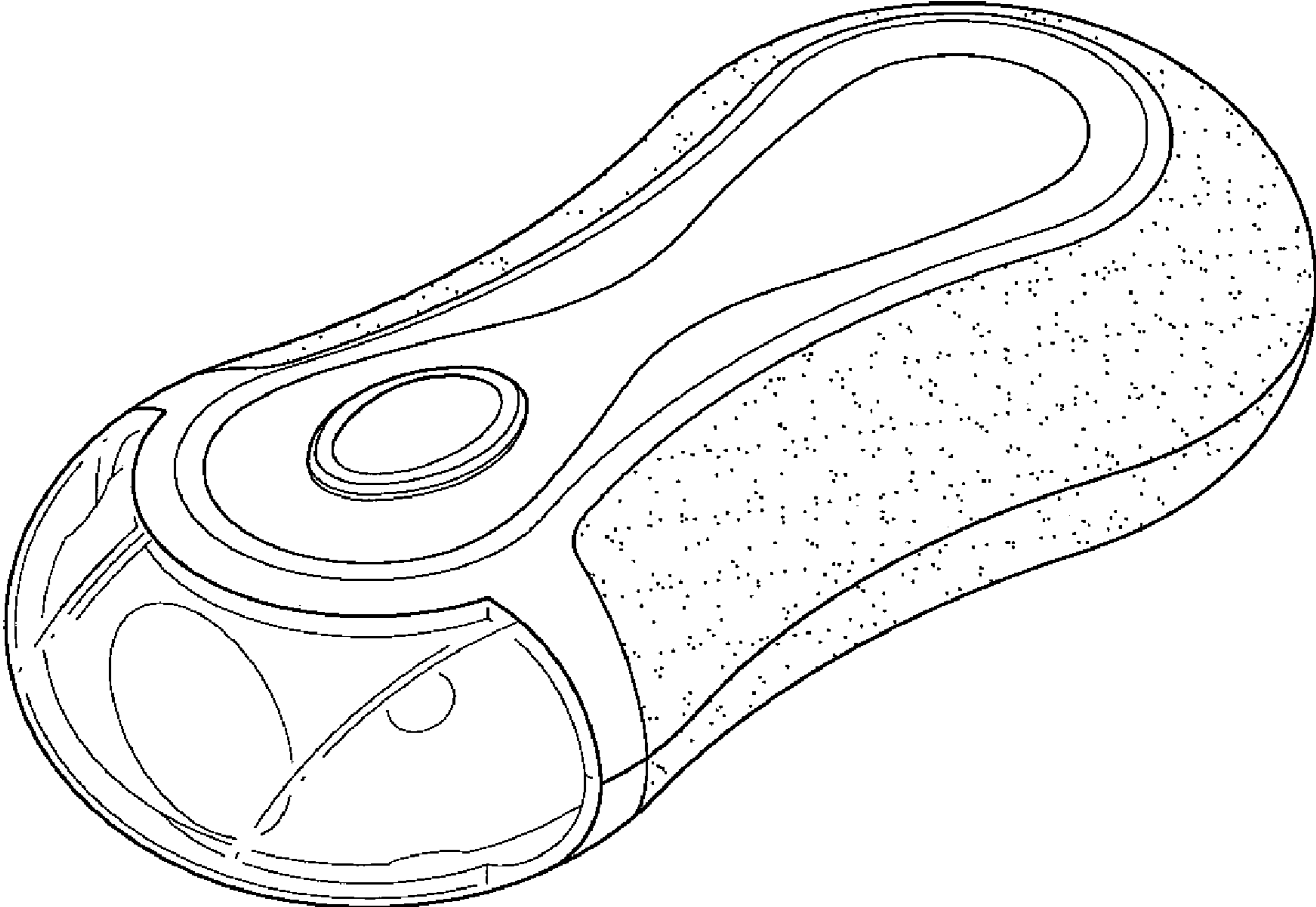

FIG. 1

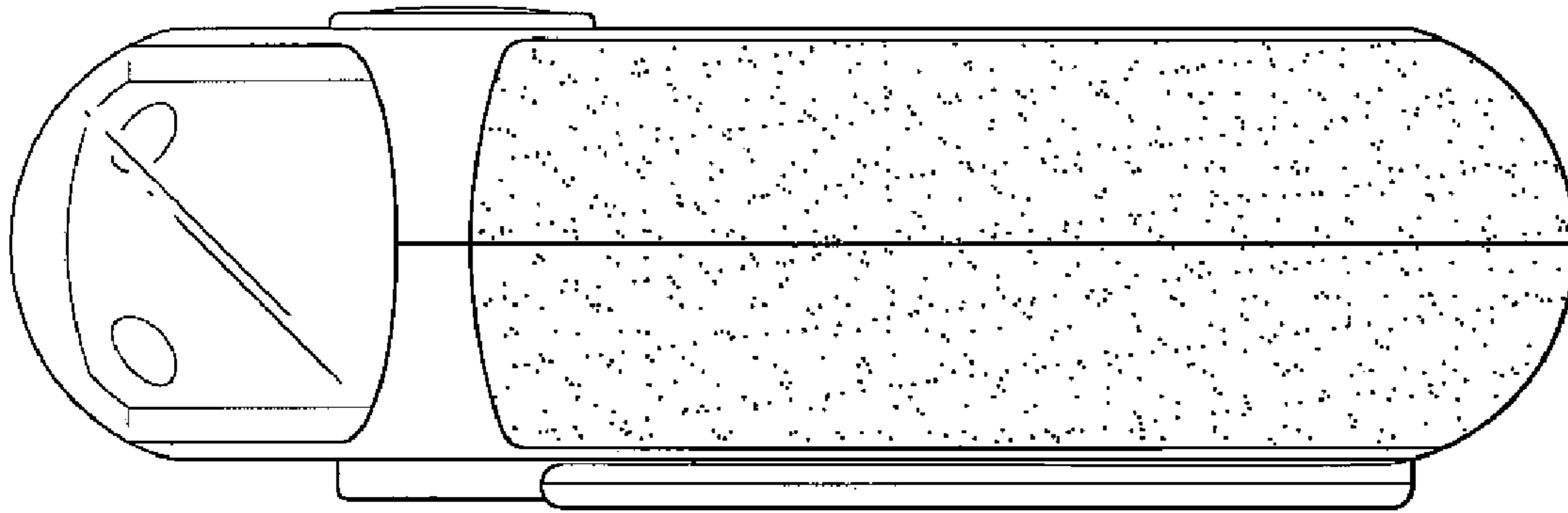

FIG. 2

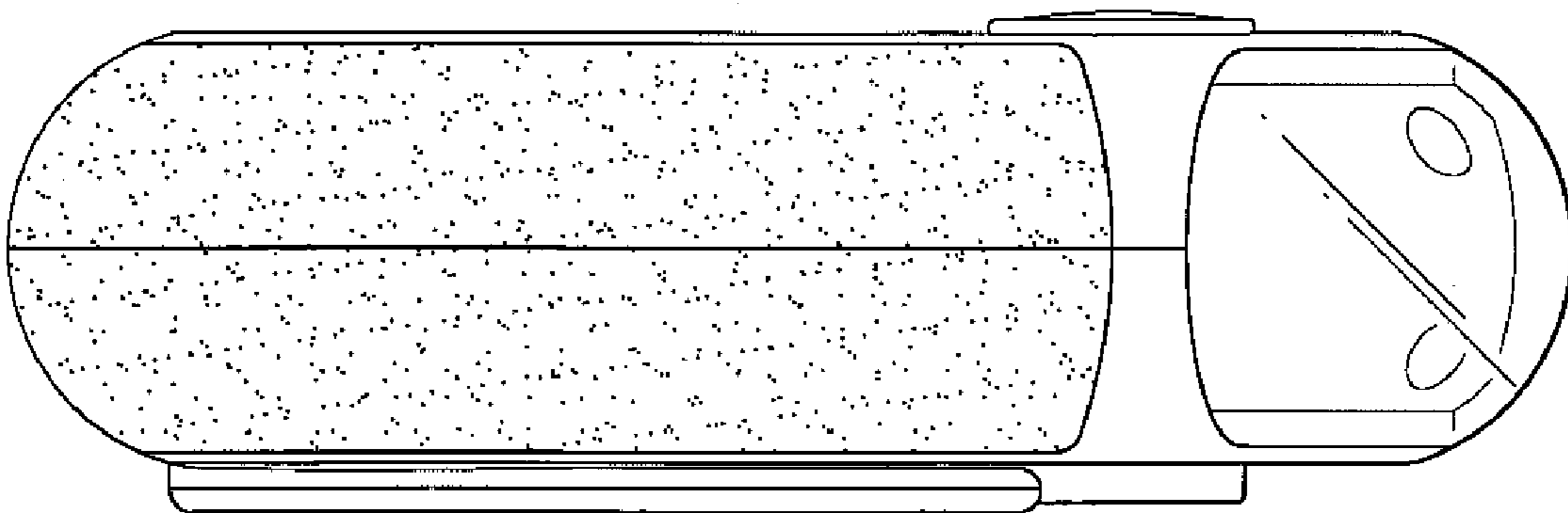

FIG. 3

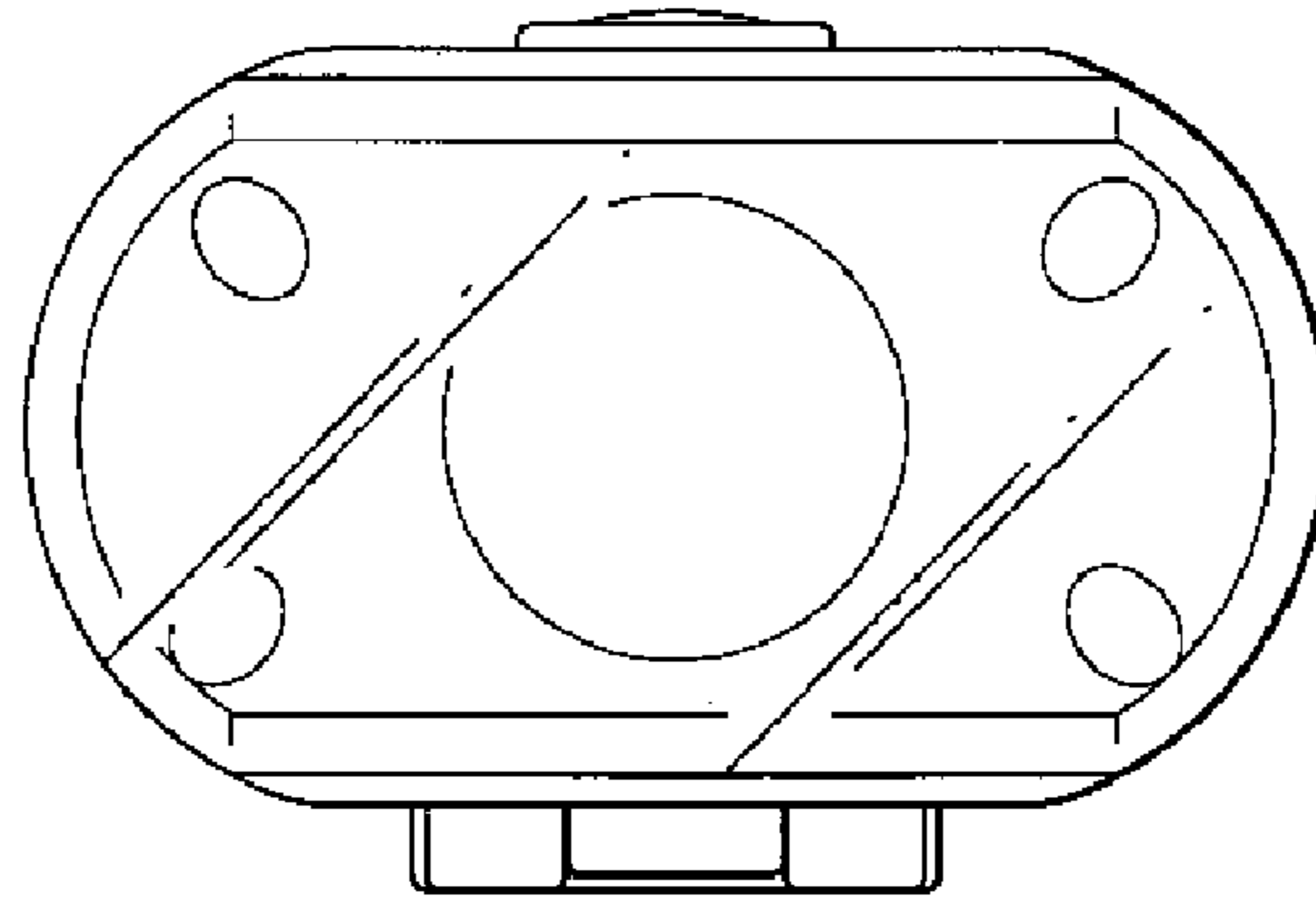

FIG. 4

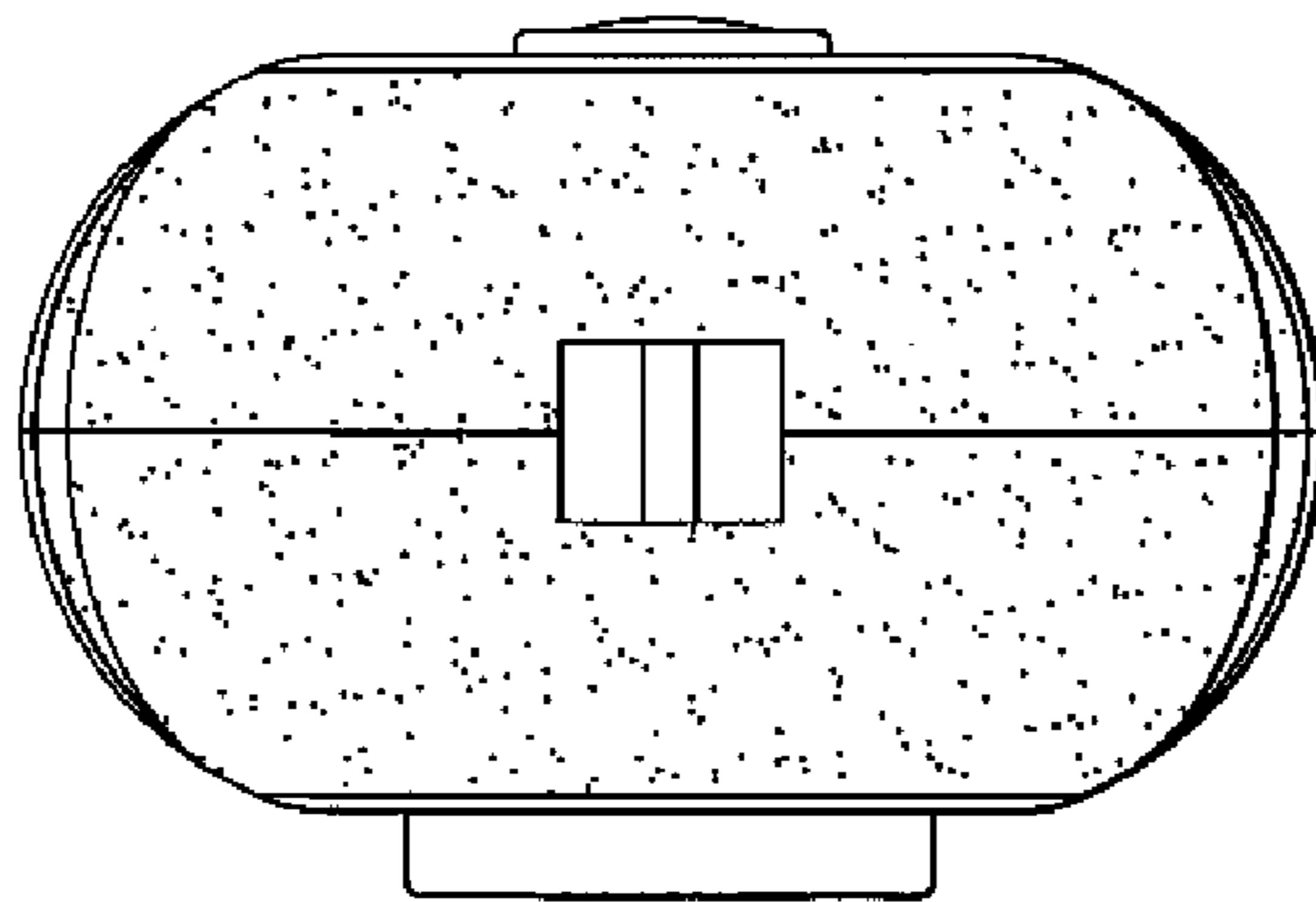

FIG. 5

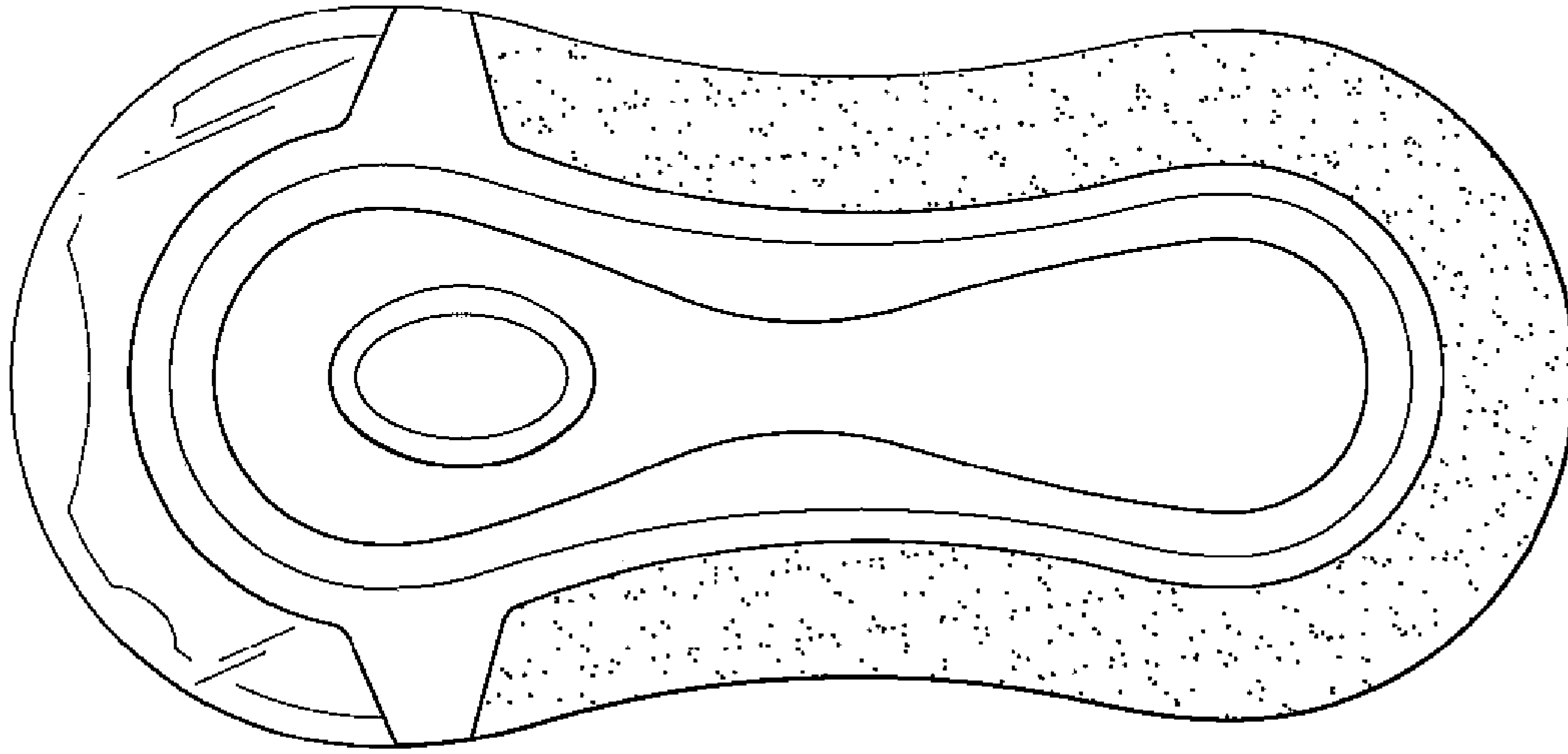

FIG. 6

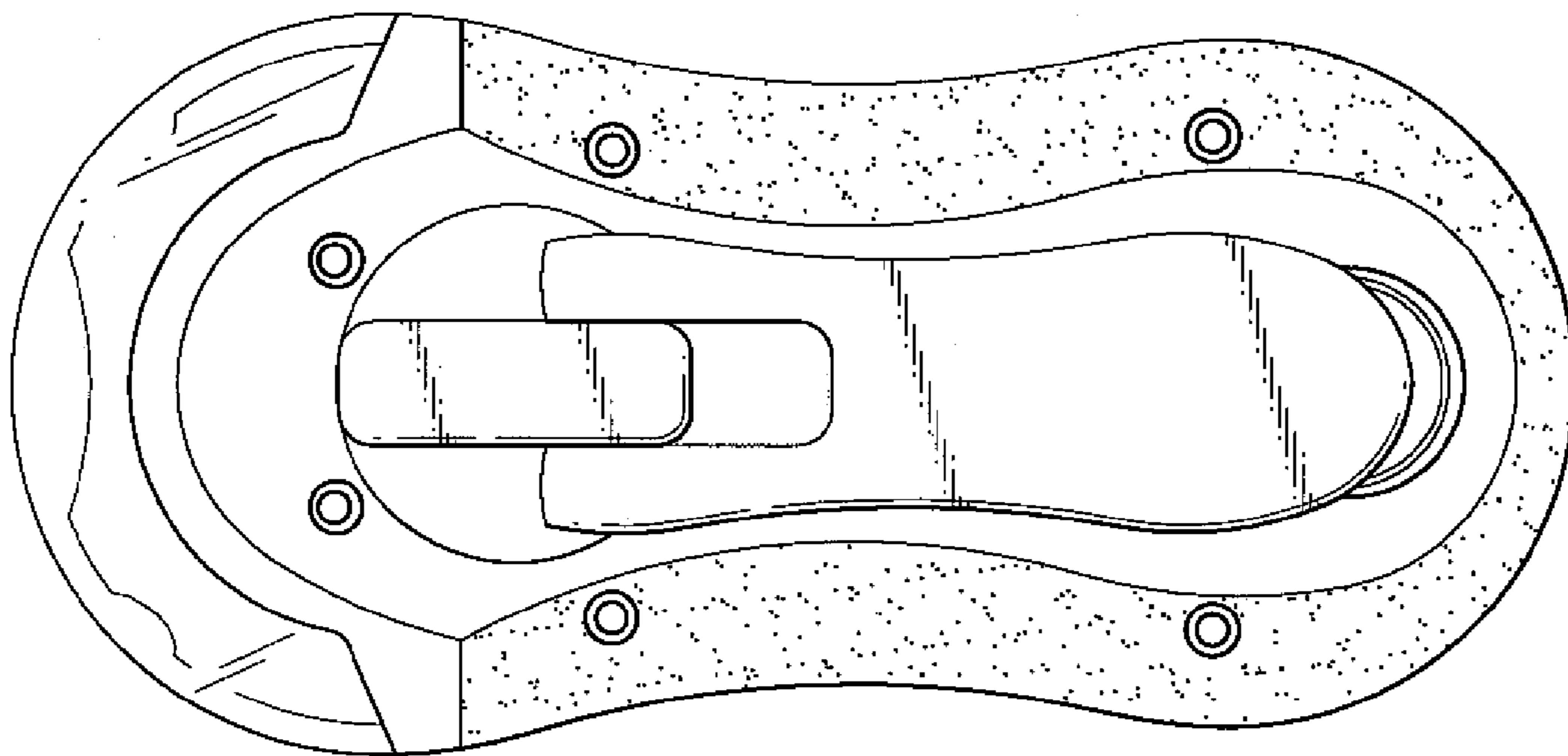

FIG. 7