

US00D561344S

(12) **United States Design Patent** (10) **Patent No.:** **US D561,344 S**  
**Kozak et al.** (45) **Date of Patent:** **\*\* Feb. 5, 2008**

(54) **LATERAL FLOW ASSAY DEVICE**

(75) Inventors: **Kenneth J. Kozak**, Cincinnati, OH (US); **Jeffrey A. Kraft**, Cincinnati, OH (US); **Jonathan Scott Maher**, Hebron, KY (US)

(73) Assignee: **Meridian Bioscience, Inc.**, Cincinnati, OH (US)

(\*\*) Term: **14 Years**

(21) Appl. No.: **29/249,355**

(22) Filed: **Oct. 3, 2006**

(51) **LOC (8) Cl.** ..... **24-02**

(52) **U.S. Cl.** ..... **D24/216**

(58) **Field of Classification Search** ..... D24/216-230;  
D10/81; 422/55, 56, 58, 61, 101, 102, 104;  
435/288.1, 304.1

See application file for complete search history.

(56) **References Cited**

**U.S. PATENT DOCUMENTS**

D221,751 S *	9/1971	Kronish et al. ....	D24/223
4,943,522 A *	7/1990	Eisinger et al. ....	422/101
D373,829 S *	9/1996	Pallender ....	D24/224
D412,990 S *	8/1999	Woolston et al. ....	D24/223
6,046,057 A *	4/2000	Nazareth et al. ....	422/56
D426,313 S *	6/2000	Woolston et al. ....	D24/223
6,299,842 B1 *	10/2001	Kozak et al. ....	422/102
D456,082 S *	4/2002	Bouse et al. ....	D24/223
6,372,516 B1 *	4/2002	Sun ....	422/56
6,998,273 B1 *	2/2006	Fleming et al. ....	422/56

\* cited by examiner

*Primary Examiner*—Ian Simmons

*Assistant Examiner*—Anhdao Doan

(74) *Attorney, Agent, or Firm*—Frost Brown Todd LLC

(57) **CLAIM**

The ornamental design for a lateral flow assay device, as shown and described.

**DESCRIPTION**

FIG. 1 is a perspective view of the first embodiment of a lateral flow assay device showing our new design;

FIG. 2 is a front elevation view thereof;

FIG. 3 is a rear elevation view thereof;

FIG. 4 is a left side elevation view thereof;

FIG. 5 is a right side elevation view thereof;

FIG. 6 is a top plan view thereof;

FIG. 7 is a bottom plan view thereof;

FIG. 8 is a perspective view of the second embodiment of a lateral flow assay device showing our new design;

FIG. 9 is a front elevation view thereof;

FIG. 10 is a rear elevation view thereof;

FIG. 11 is a left side elevation view thereof;

FIG. 12 is a right side elevation view thereof;

FIG. 13 is a top plan view thereof; and,

FIG. 14 is a bottom plan view thereof.

The broken lines in FIGS. 8-12 and 14 are for illustrative purposes only and form no part of the claimed design.

**1 Claim, 8 Drawing Sheets**

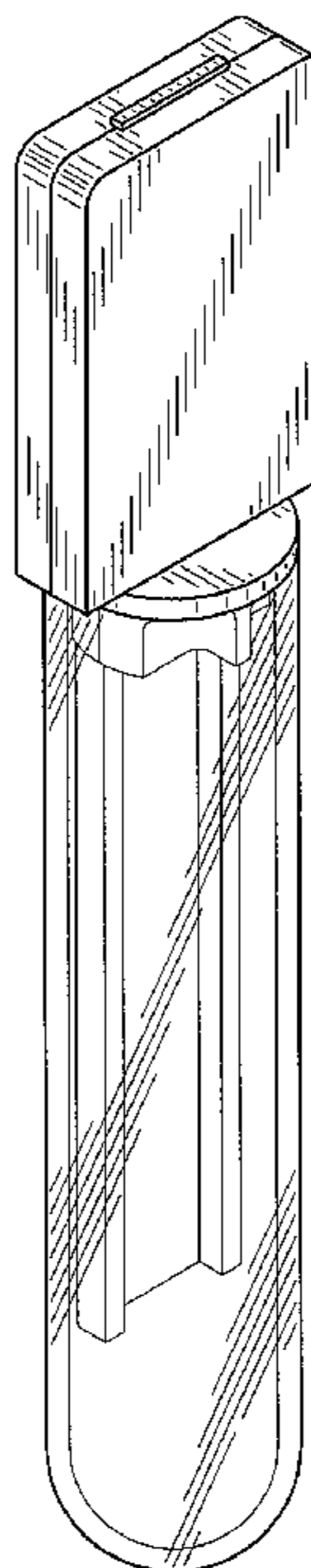

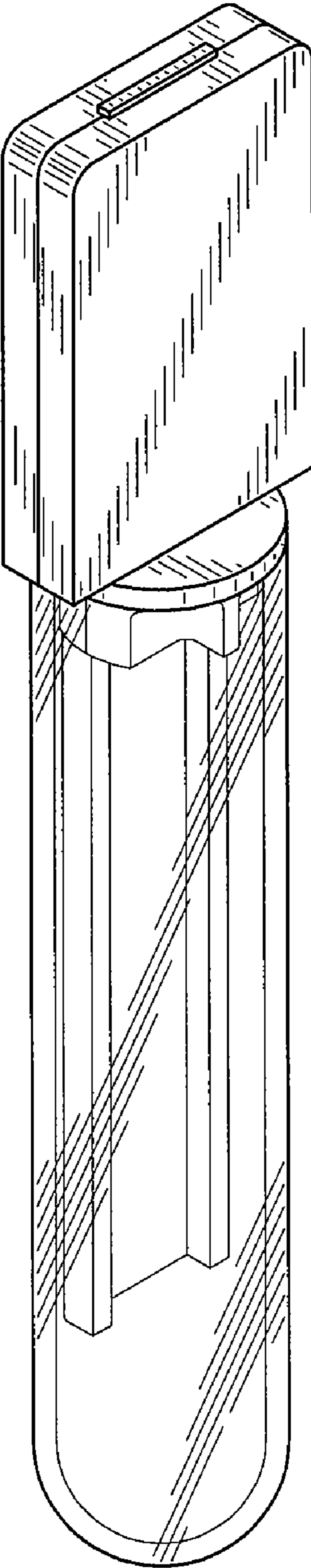

FIG. 1

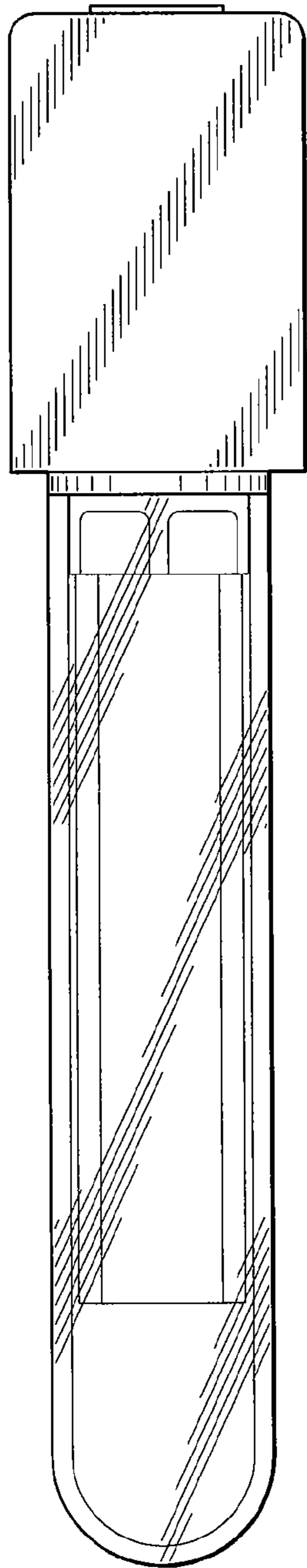

FIG. 2

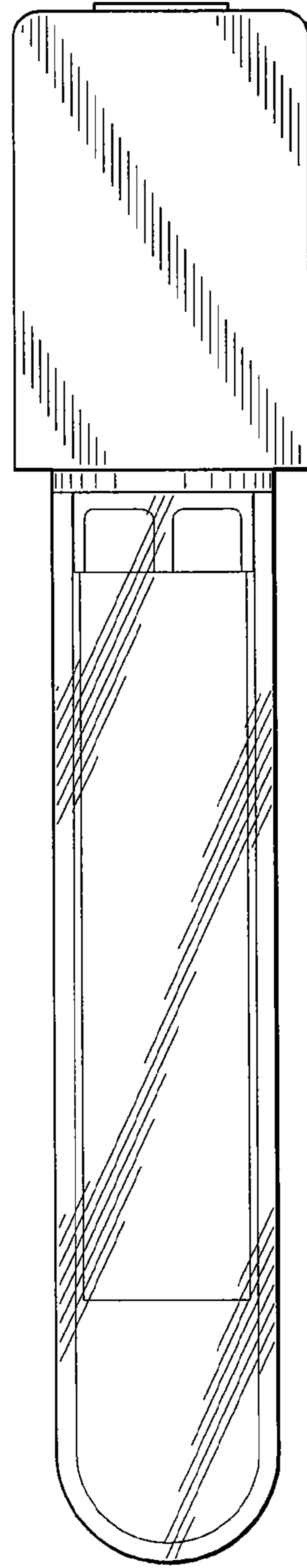

FIG. 3

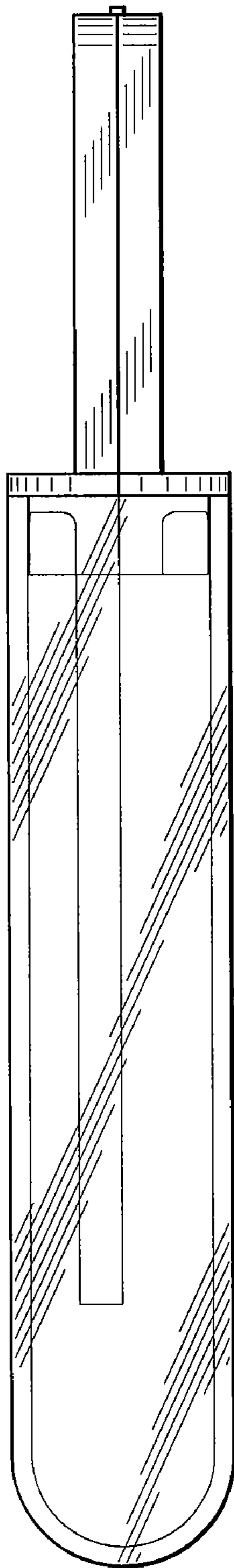

FIG. 4

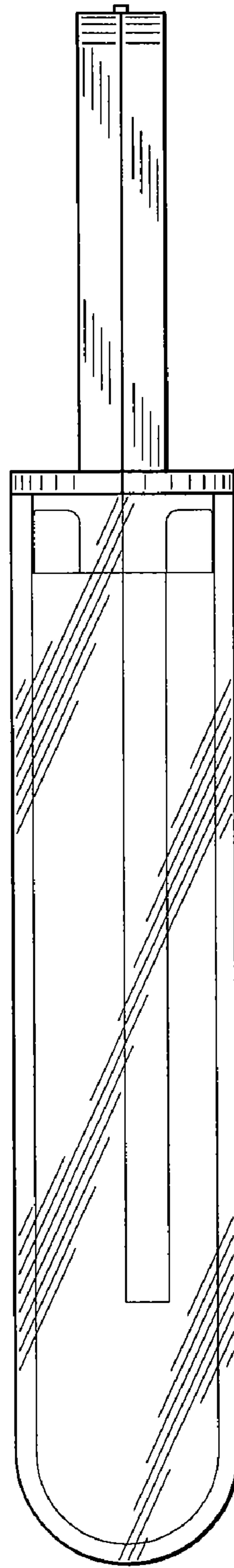

FIG. 5

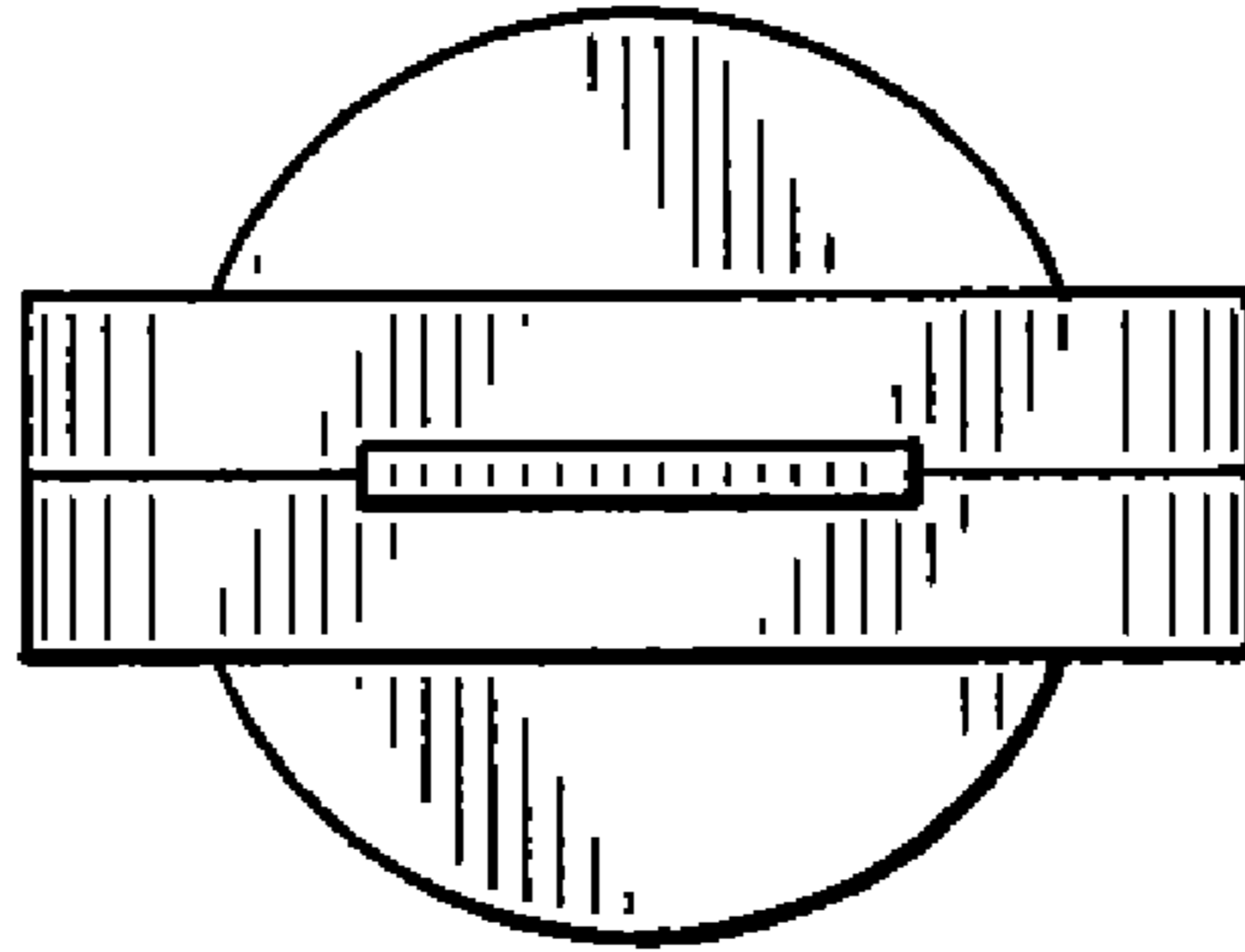

FIG. 6

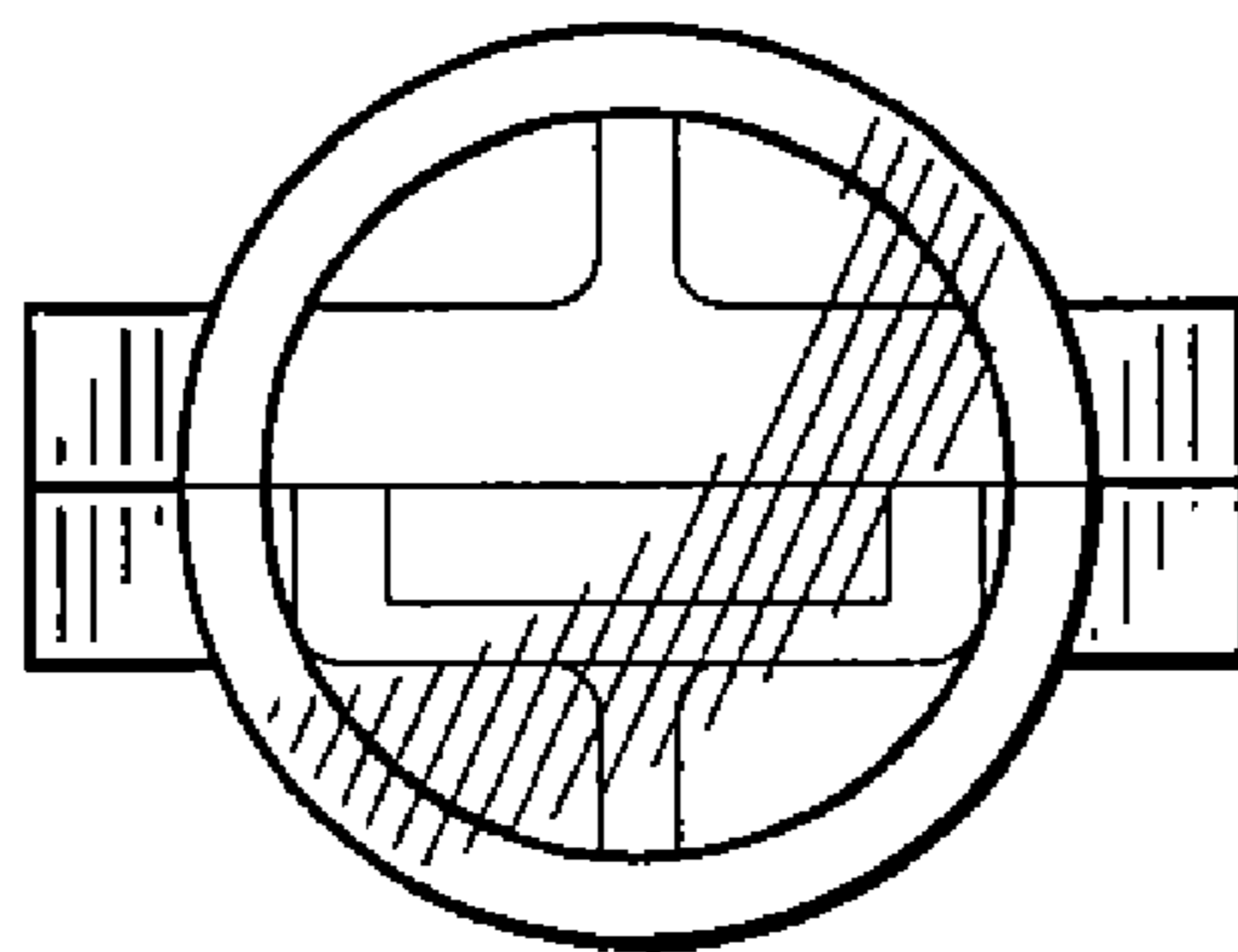

FIG. 7

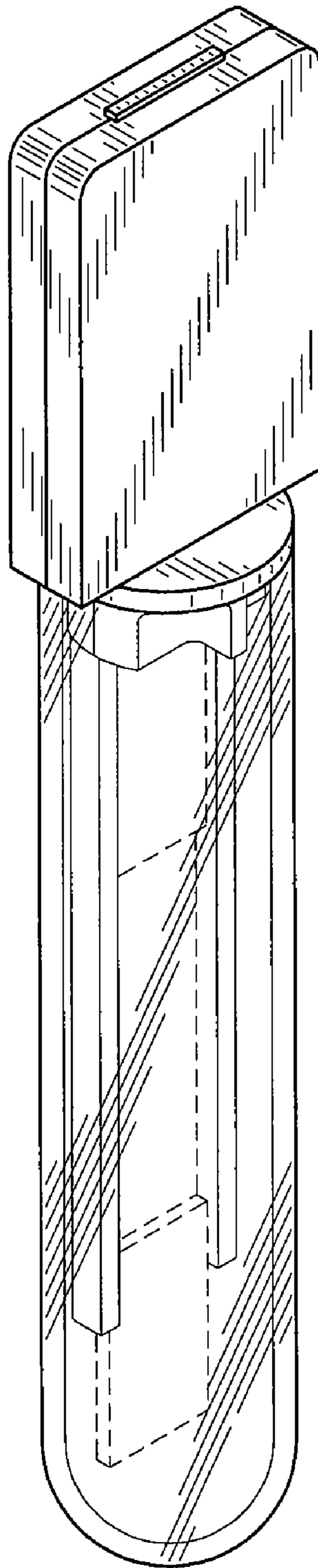

FIG. 8

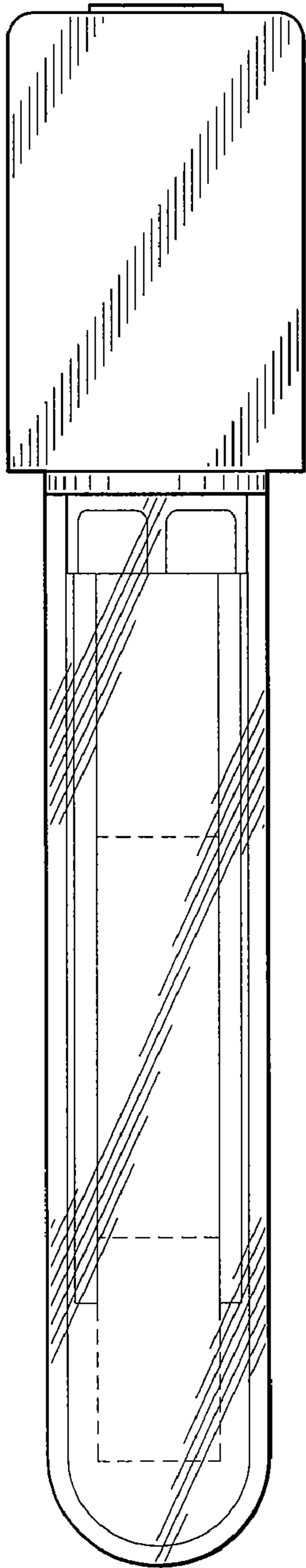

FIG. 9

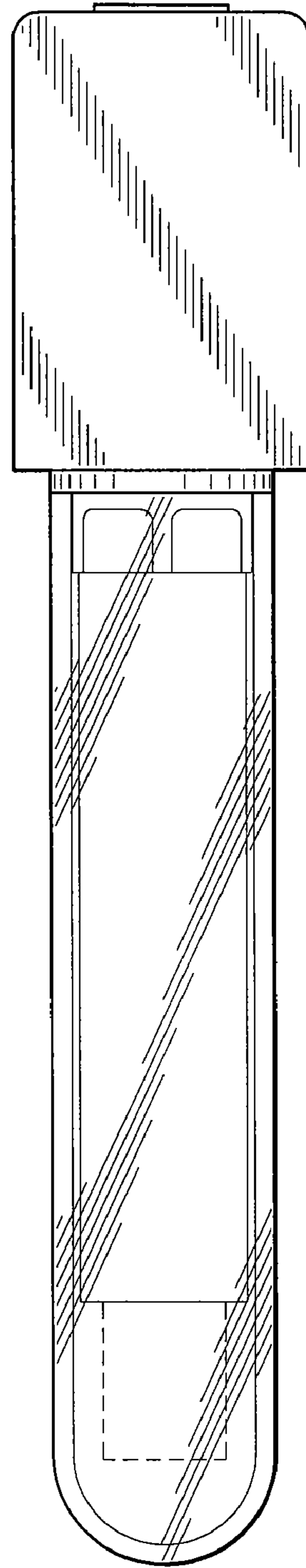

FIG. 10

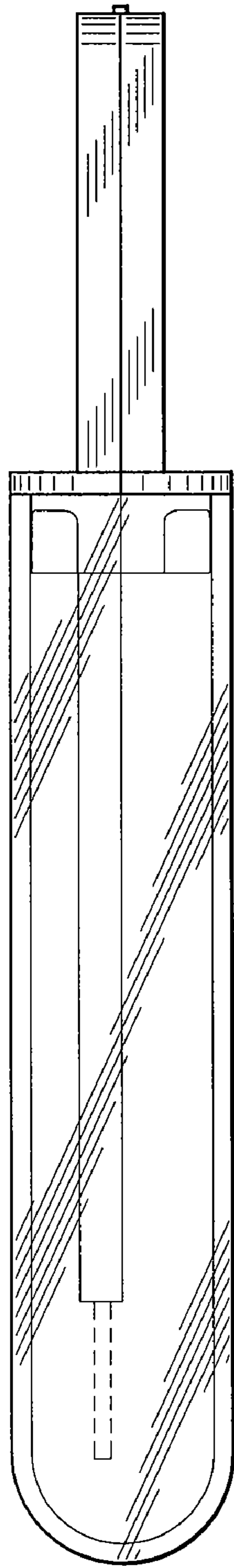

FIG. 11

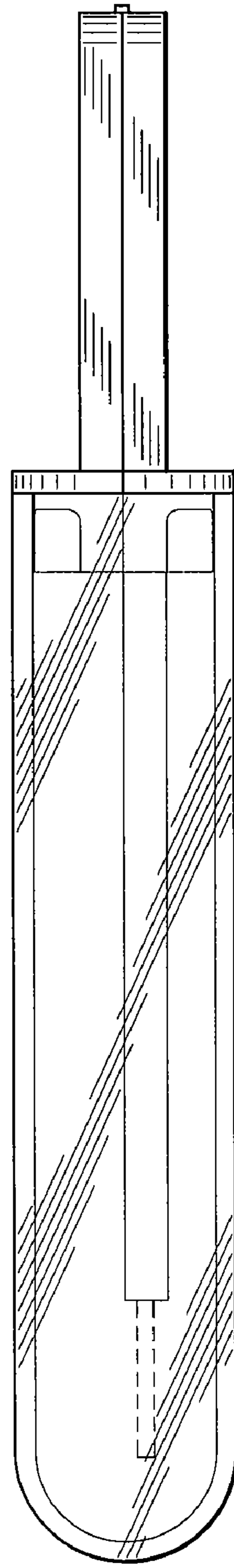

FIG. 12



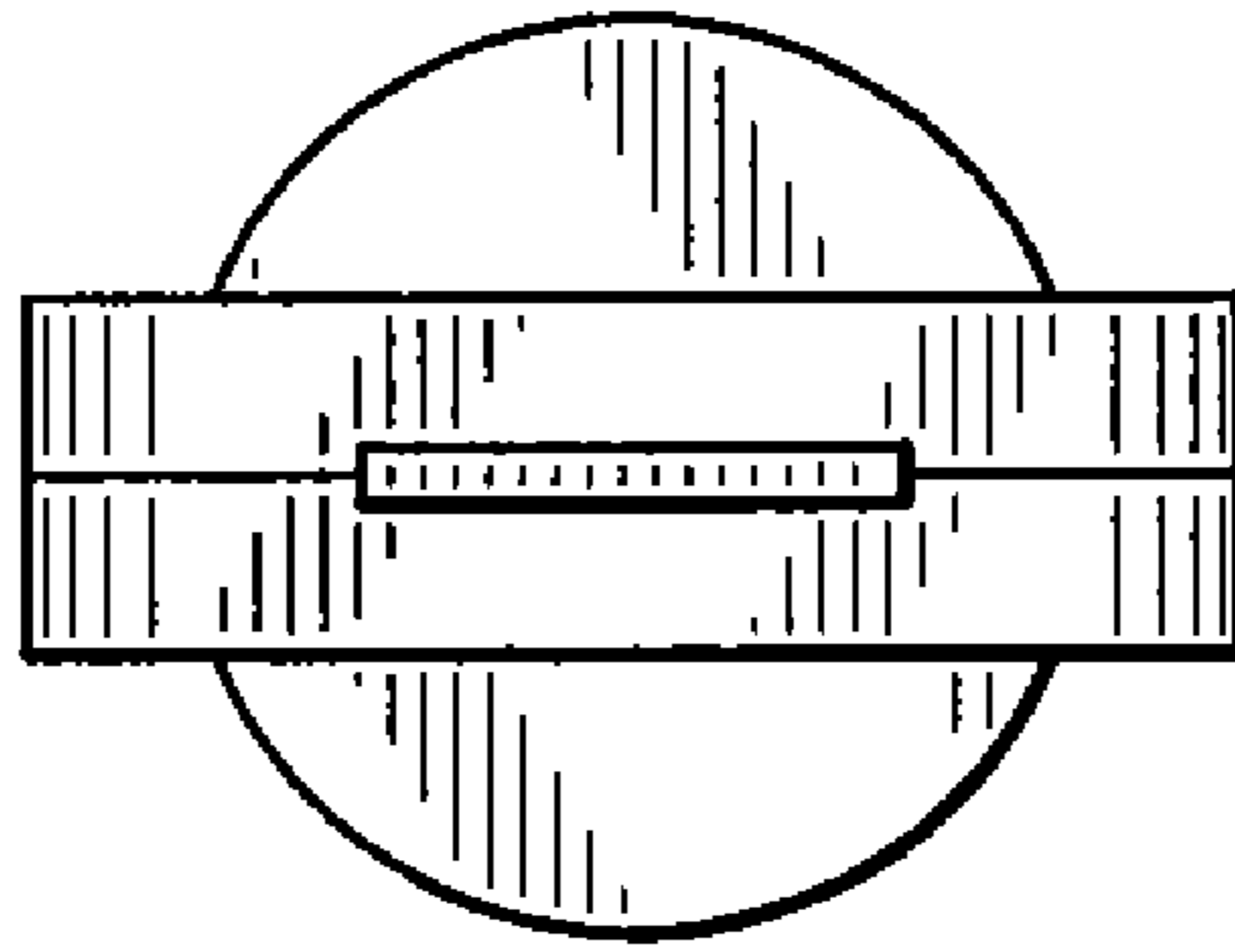

FIG. 13

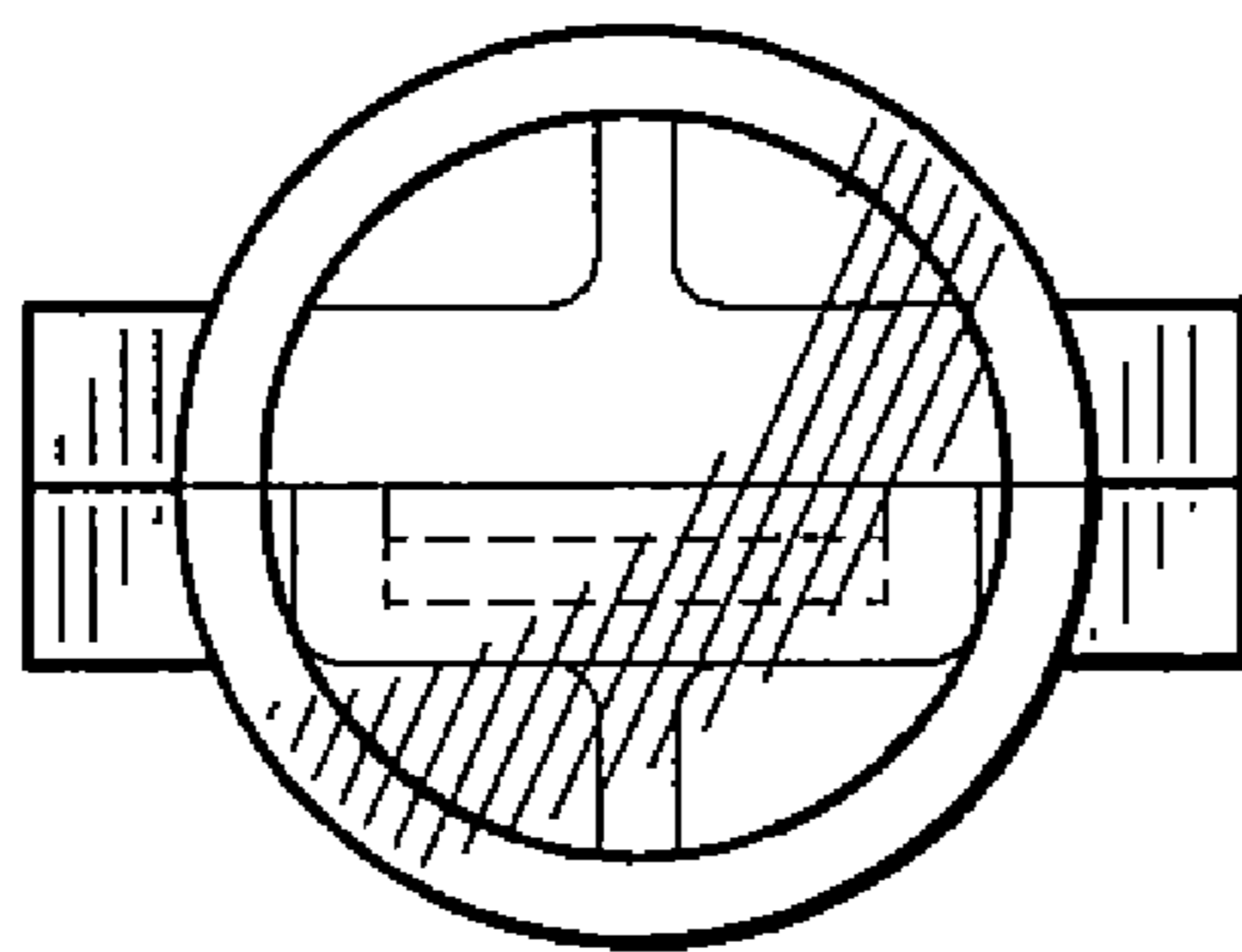

FIG. 14