



US00D561321S

(12) **United States Design Patent**
Hong

(10) **Patent No.:** **US D561,321 S**

(45) **Date of Patent:** **** Feb. 5, 2008**

(54) **SLIM CONVERTER**

6,999,315 B2 * 2/2006 Inoue 361/700

(75) Inventor: **Weibi Hong**, Shanghai (CN)

* cited by examiner

(73) Assignee: **New Focus Lighting and Power Technology (Shanghai) Co., Ltd.**, Shanghai (CN)

Primary Examiner—Lisa Lichtenstein

(74) *Attorney, Agent, or Firm*—Raymond Y. Chan; David and Raymond Patent Firm

(**) Term: **14 Years**

(57) **CLAIM**

(21) Appl. No.: **29/237,210**

The ornamental design for a slim converter, as shown.

(22) Filed: **Aug. 29, 2005**

DESCRIPTION

(51) **LOC (8) Cl.** **23-04**

FIG. 1 is a perspective view showing my new design.

(52) **U.S. Cl.** **D23/370**

FIG. 2 is a front view thereof.

(58) **Field of Classification Search** D23/370;
361/695–697

FIG. 3 is a rear view thereof.

See application file for complete search history.

FIG. 4 is a right end view thereof.

FIG. 5 is a left end view thereof.

(56) **References Cited**

FIG. 6 is a top view thereof; and,

FIG. 7 is a bottom view thereof.

U.S. PATENT DOCUMENTS

5,502,618 A * 3/1996 Chiou 361/695

1 Claim, 7 Drawing Sheets

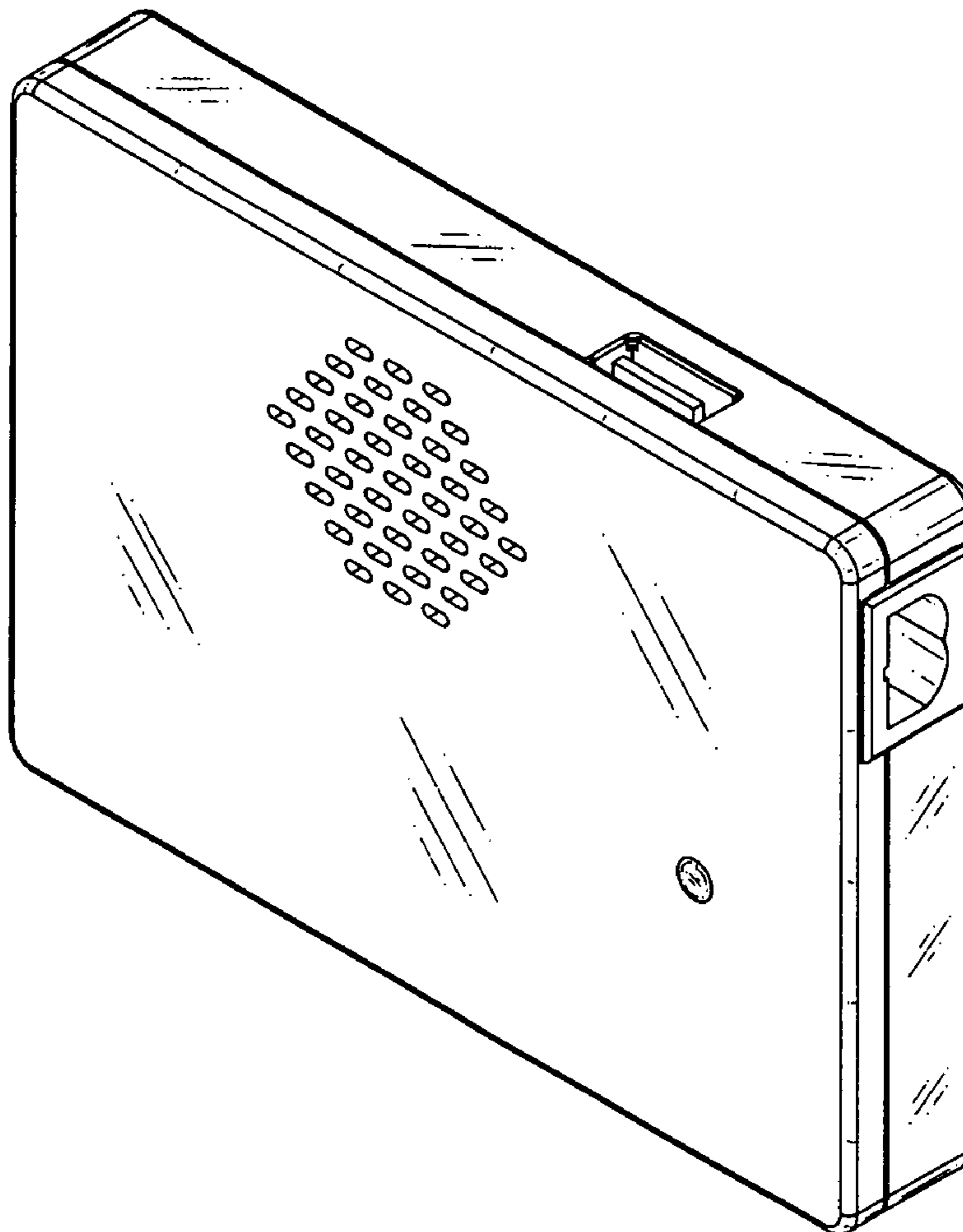

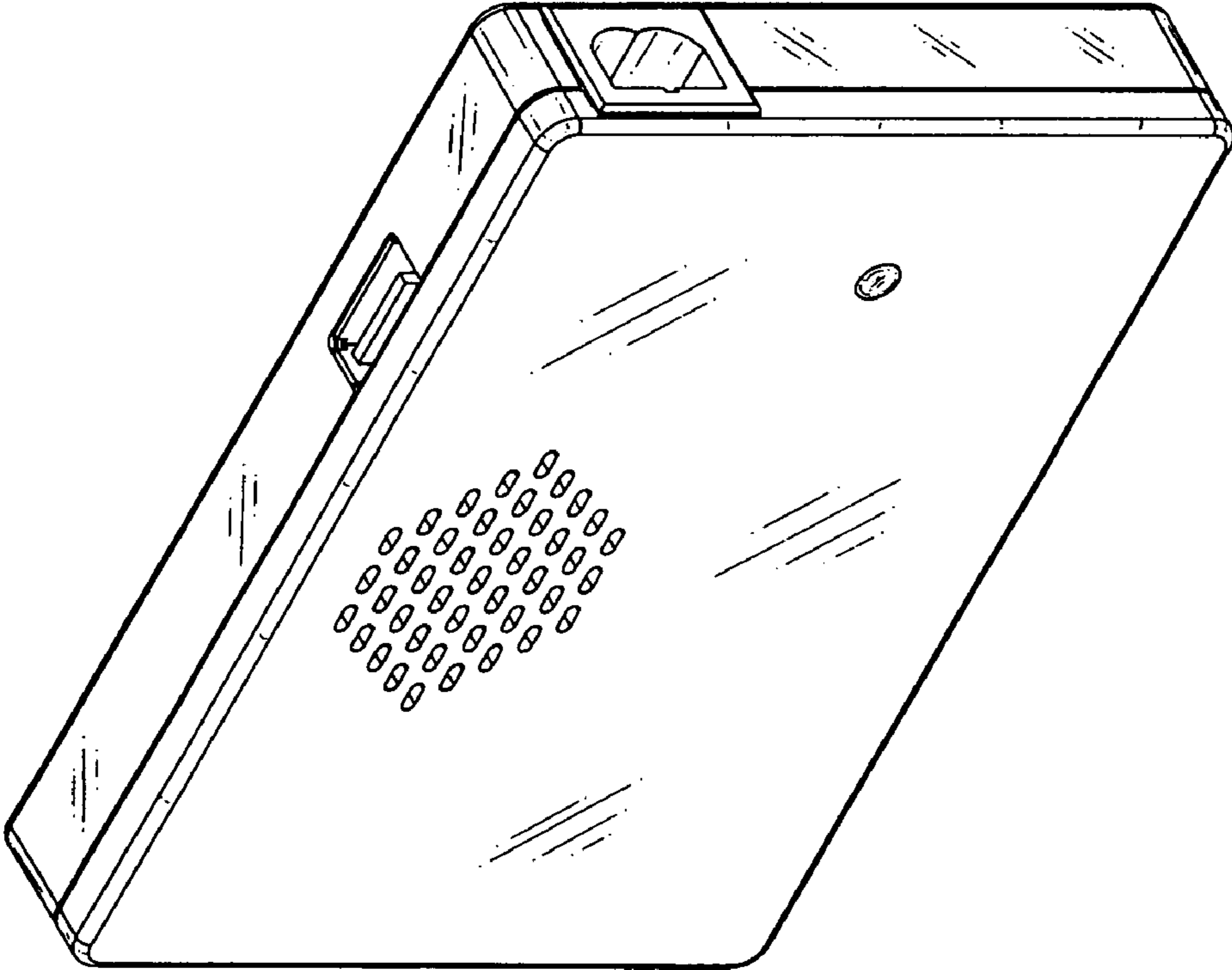

FIG. 1

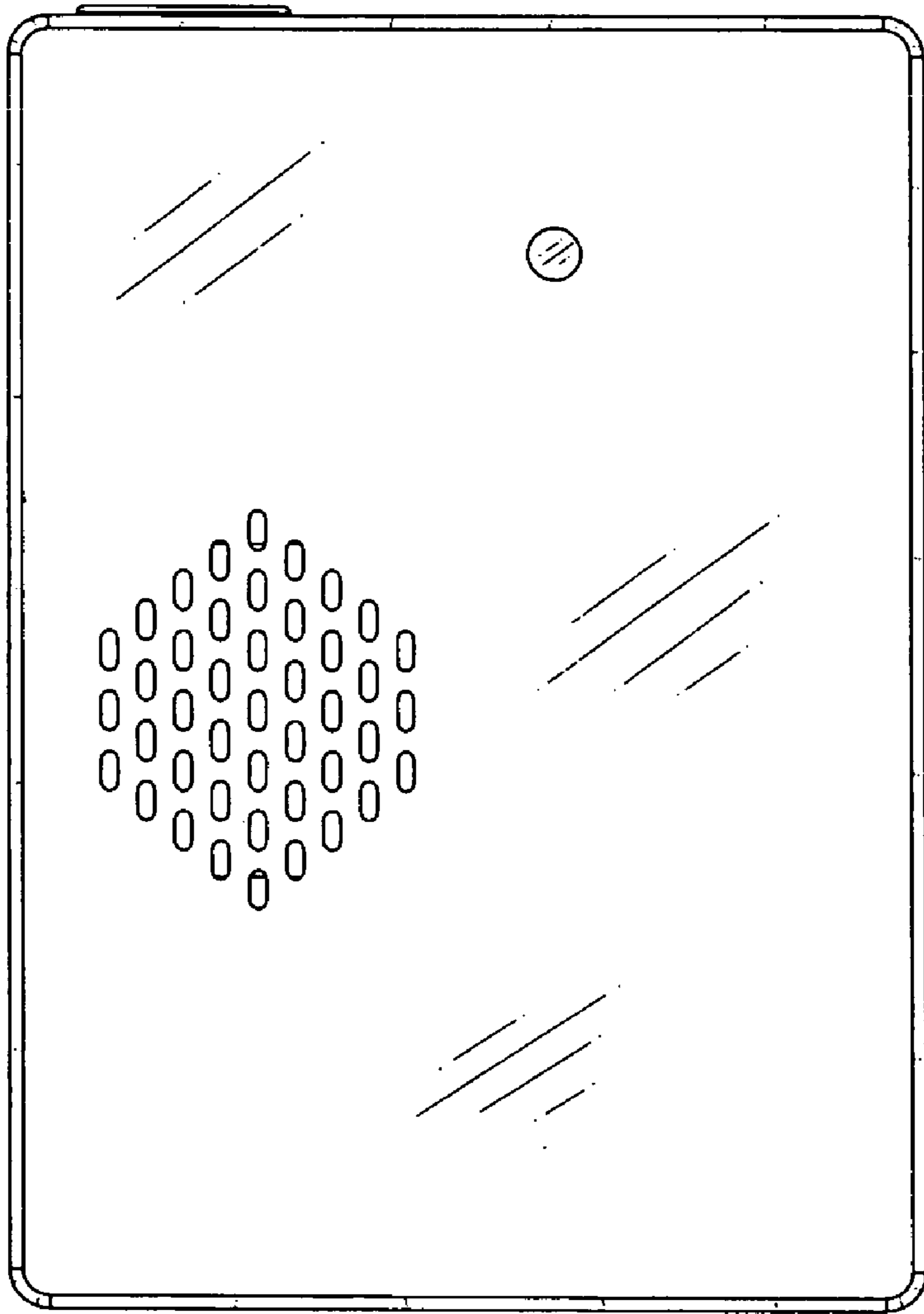

FIG. 2

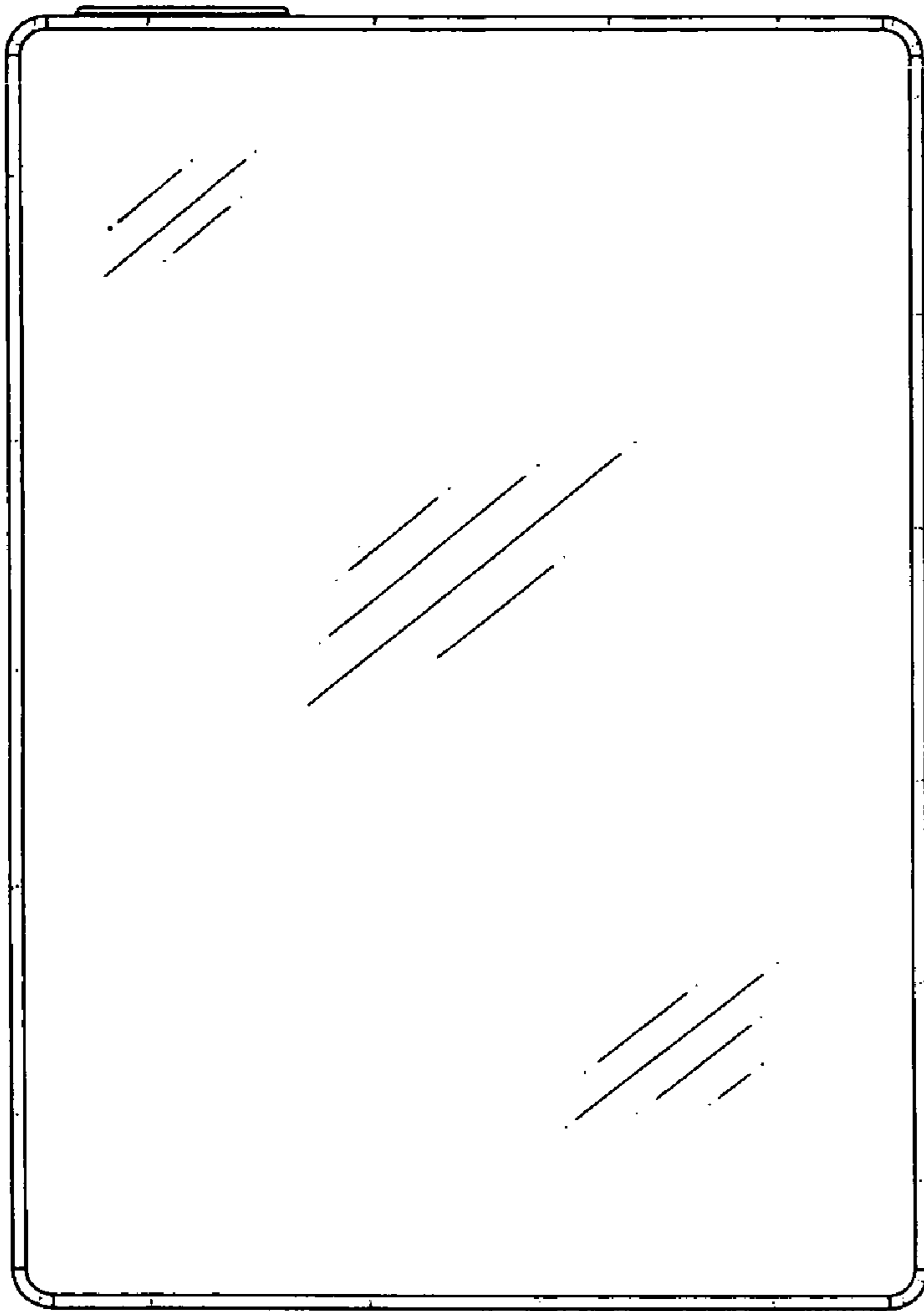

FIG. 3

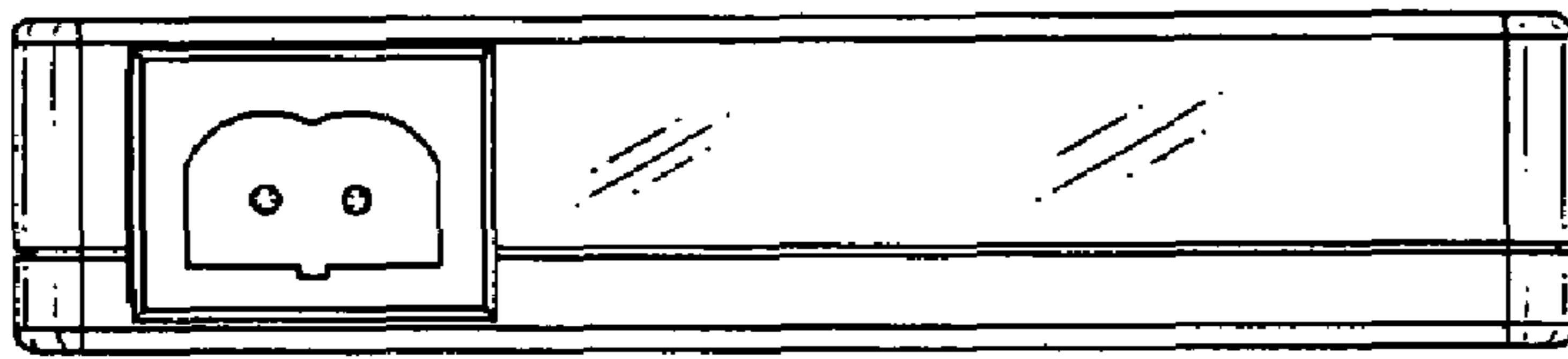

FIG. 4

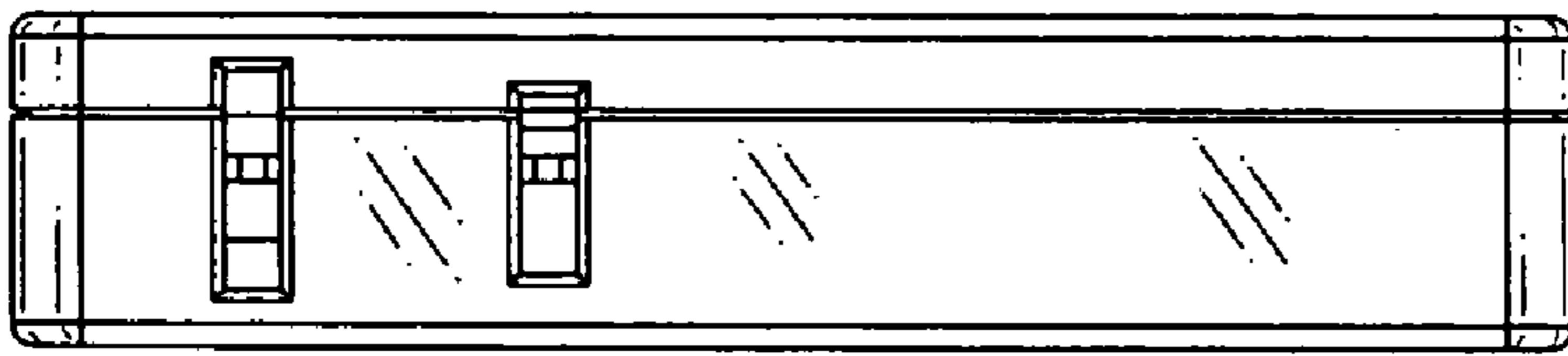

FIG. 5

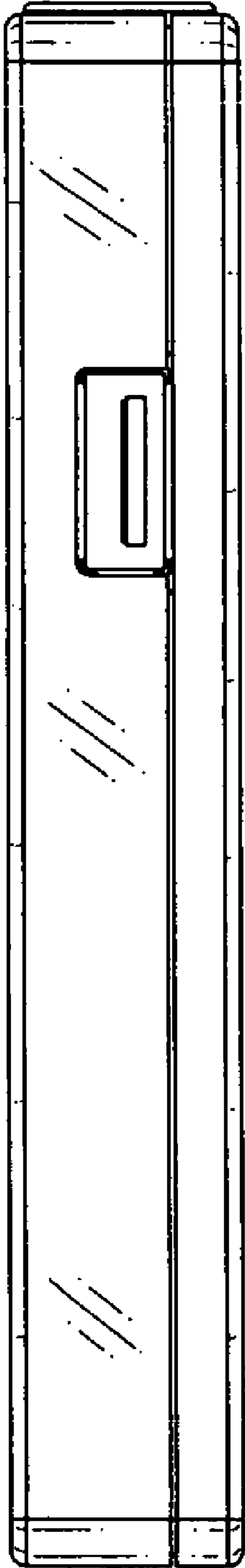

FIG. 6

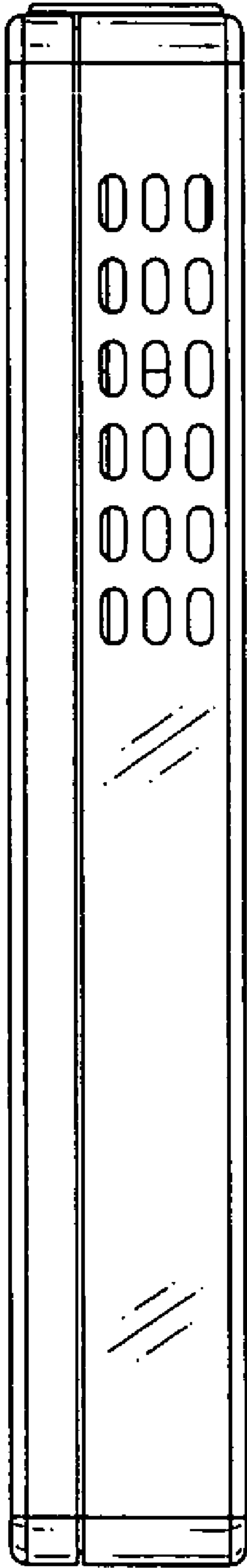

FIG. 7