

US00D561313S

(12) **United States Design Patent**
Kolin et al.

(10) **Patent No.:** **US D561,313 S**

(45) **Date of Patent:** **** Feb. 5, 2008**

(54) **SHOWER PANEL**

D550,337 S * 9/2007 Stein D23/304

(75) Inventors: **Peter Kolin**, Schwäbisch Gmünd (DE);
Andras Haug, Stuttgart (DE)

* cited by examiner

Primary Examiner—Robert A. Delehanty

(73) Assignee: **Hansgrohe AG** (DE)

(74) *Attorney, Agent, or Firm*—Leon E. Redman; Lloyd D. Doigan

(**) Term: **14 Years**

(21) Appl. No.: **29/248,497**

(57) **CLAIM**

(22) Filed: **Aug. 18, 2006**

The ornamental design for a shower panel, as shown and described.

(30) **Foreign Application Priority Data**

DESCRIPTION

Feb. 23, 2006 (EM) 000484597-0003

(51) **LOC (8) Cl.** **23-02**

FIG. 1 is a front perspective view of a shower panel showing our design;

(52) **U.S. Cl.** **D23/304**

FIG. 2 is a front elevational view thereof;

(58) **Field of Classification Search** D23/228,
D23/275, 283, 303–304; 4/546, 552, 559,
4/567–569, 596–597, 615, 661

FIG. 3 is a left side elevational view thereof;

See application file for complete search history.

FIG. 4 is a rear elevational view thereof;

FIG. 5 is a right side elevational view thereof;

(56) **References Cited**

FIG. 6 is a top plan view thereof; and,

FIG. 7 is a bottom plan view thereof.

U.S. PATENT DOCUMENTS

The broken lines in the Figures are for illustrative purposes only and form no part of the claimed design.

D540,924 S * 4/2007 Bouroullec et al. D23/304

D540,925 S * 4/2007 Garner D23/304

D541,394 S * 4/2007 Toyohara D23/304

1 Claim, 4 Drawing Sheets

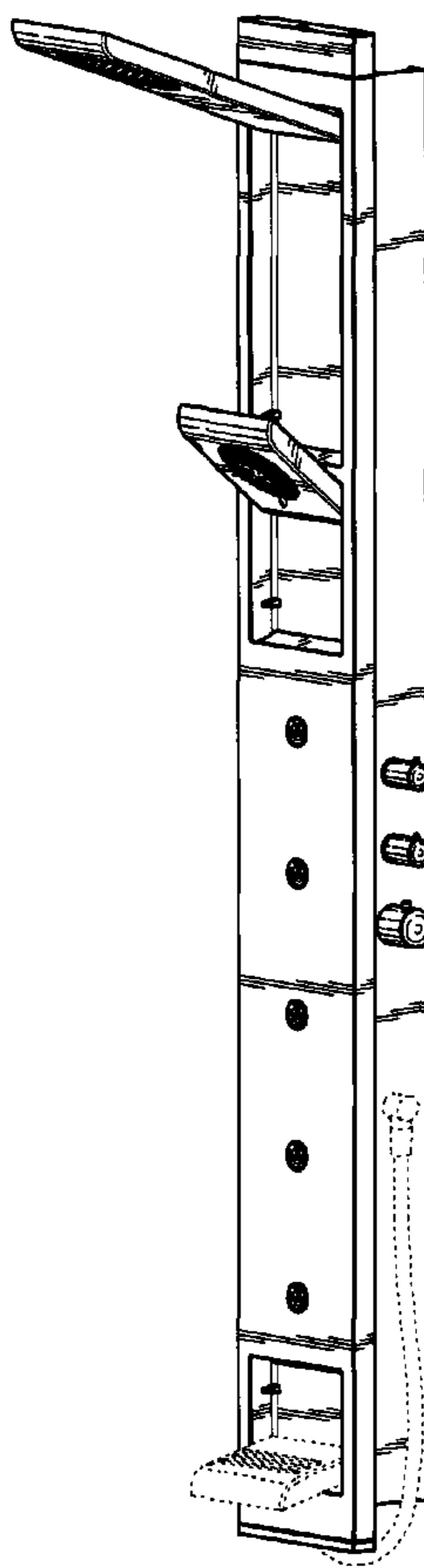

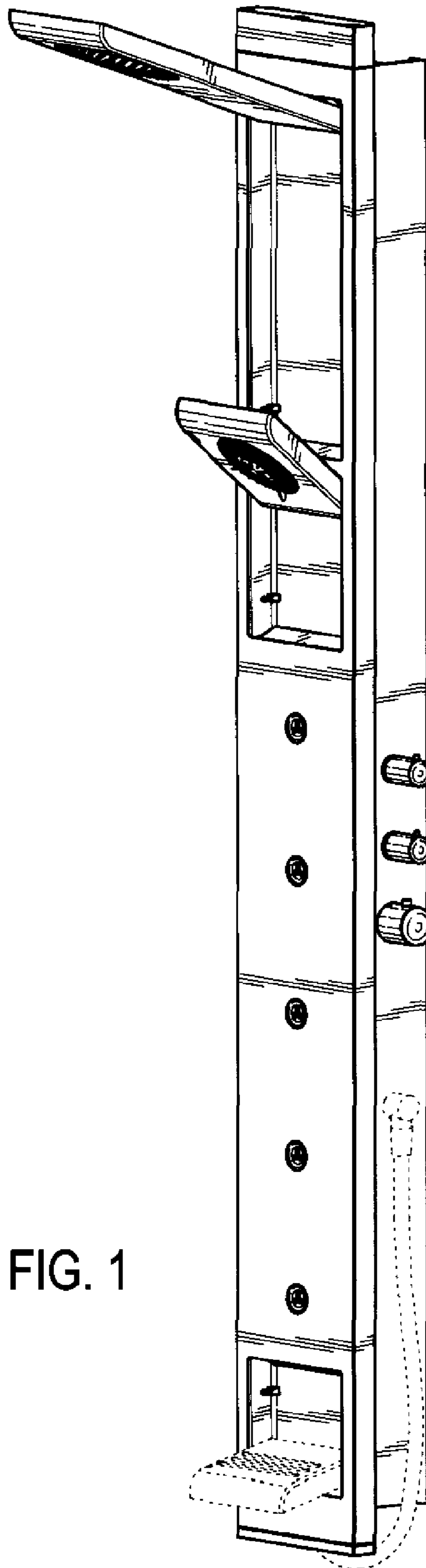

FIG. 1

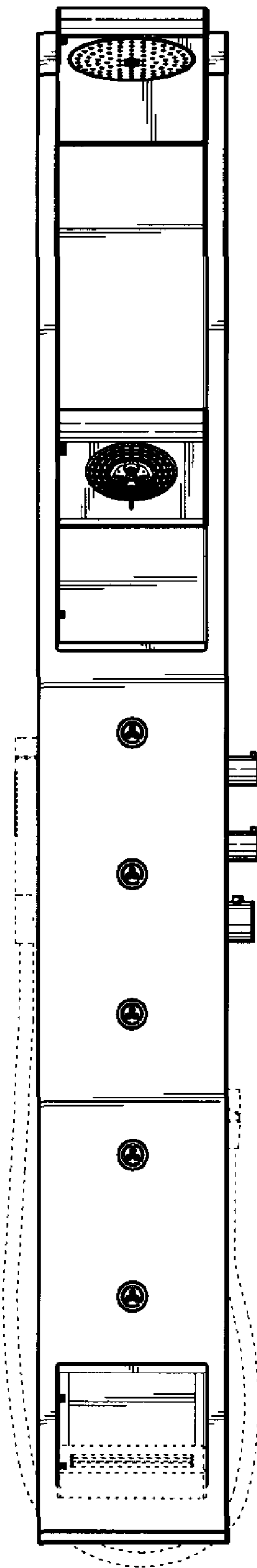

FIG. 2

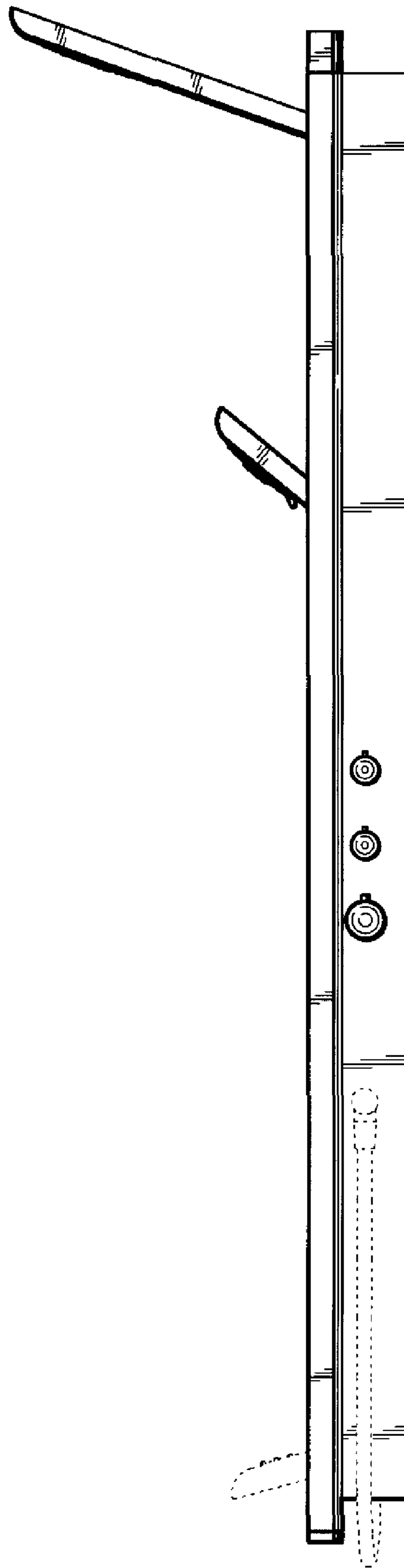

FIG. 3

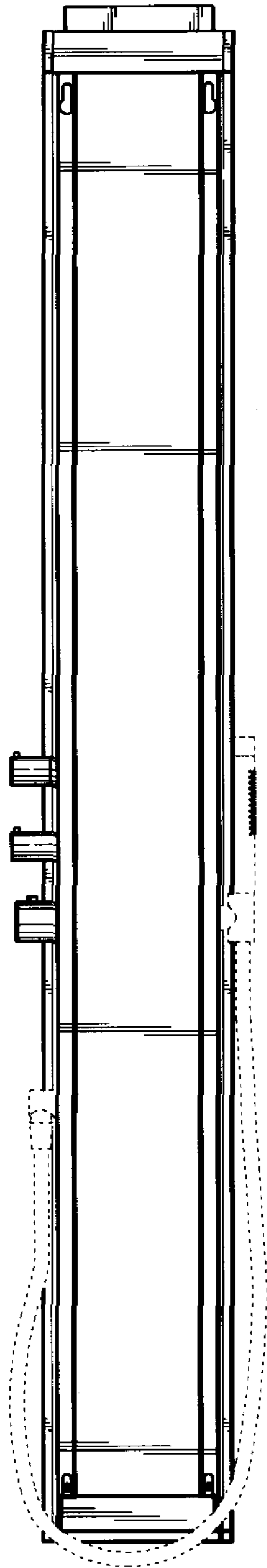

FIG. 4

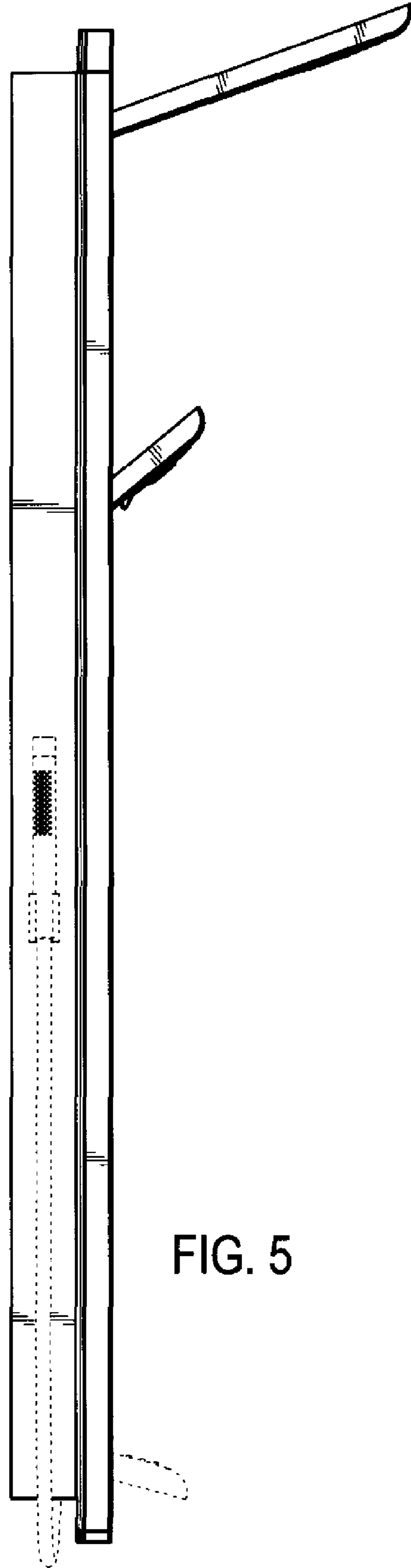

FIG. 5

FIG. 6

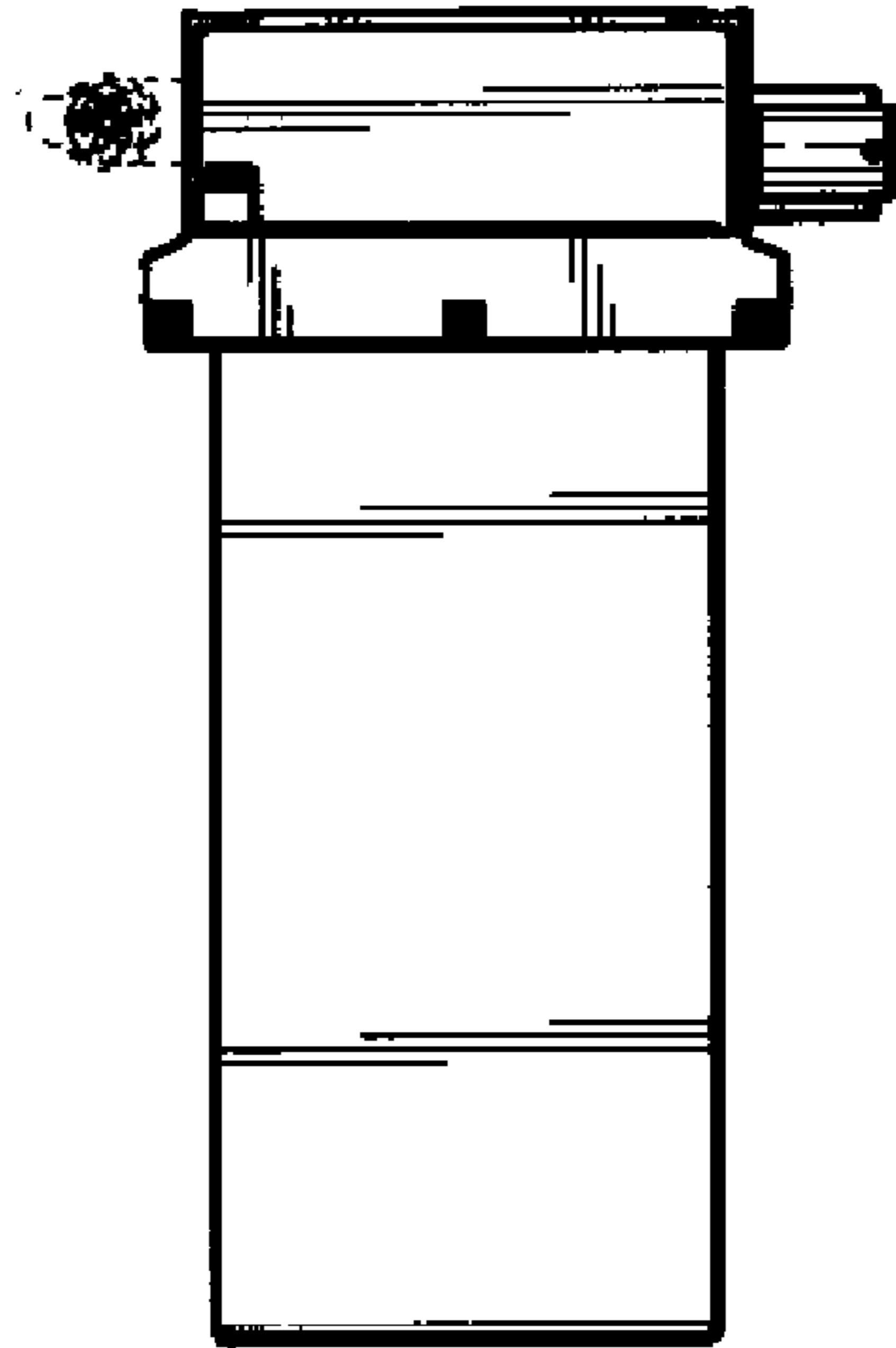

FIG. 7

