



US00D561121S

(12) **United States Design Patent**
Mochizuki et al.

(10) **Patent No.:** **US D561,121 S**

(45) **Date of Patent:** **** Feb. 5, 2008**

(54) **HEAT SINK**

(75) Inventors: **Masataka Mochizuki**, Tokyo (JP); **Yuji Saito**, Tokyo (JP)

(73) Assignee: **Fujikura Ltd.**, Tokyo (JP)

(**) Term: **14 Years**

(21) Appl. No.: **29/271,908**

(22) Filed: **Jan. 30, 2007**

(51) **LOC (8) Cl.** **13-03**

(52) **U.S. Cl.** **D13/179**

(58) **Field of Classification Search** D13/179;
165/80.3, 104.33, 151, 122, 185; 257/706,
257/707, 718-722; 361/687, 695, 697, 700,
361/702, 704, 709, 710, 711, 719

See application file for complete search history.

(56) **References Cited**

U.S. PATENT DOCUMENTS

6,407,919	B1 *	6/2002	Chou	361/697
D501,450	S *	2/2005	Watanabe et al.	D13/179
7,221,567	B2 *	5/2007	Otsuki et al.	361/695
2002/0182068	A1 *	12/2002	Liu	415/176
2005/0141992	A1 *	6/2005	Lin	415/176
2005/0271506	A1 *	12/2005	Pan	415/176

2005/0280992	A1 *	12/2005	Carter et al.	361/697
2006/0067053	A1 *	3/2006	Yu et al.	361/704
2006/0219386	A1 *	10/2006	Hsia et al.	165/80.3

* cited by examiner

Primary Examiner—Selina Sikder

(74) *Attorney, Agent, or Firm*—Sughrue Mion, PLLC

(57) **CLAIM**

The ornamental design for a heat sink, as shown and described.

DESCRIPTION

FIG. 1 is a perspective view of the top, front and left side of a heat sink showing our new design;

FIG. 2 is a front elevational view thereof;

FIG. 3 is a right elevational view thereof;

FIG. 4 is a left elevational view thereof;

FIG. 5 is a top plan view thereof;

FIG. 6 is a bottom plan view thereof; and,

FIG. 7 is a perspective view similar to FIG. 1 showing the fan removed from the extrusion.

A rear elevational view is the same as the right elevational view.

1 Claim, 7 Drawing Sheets

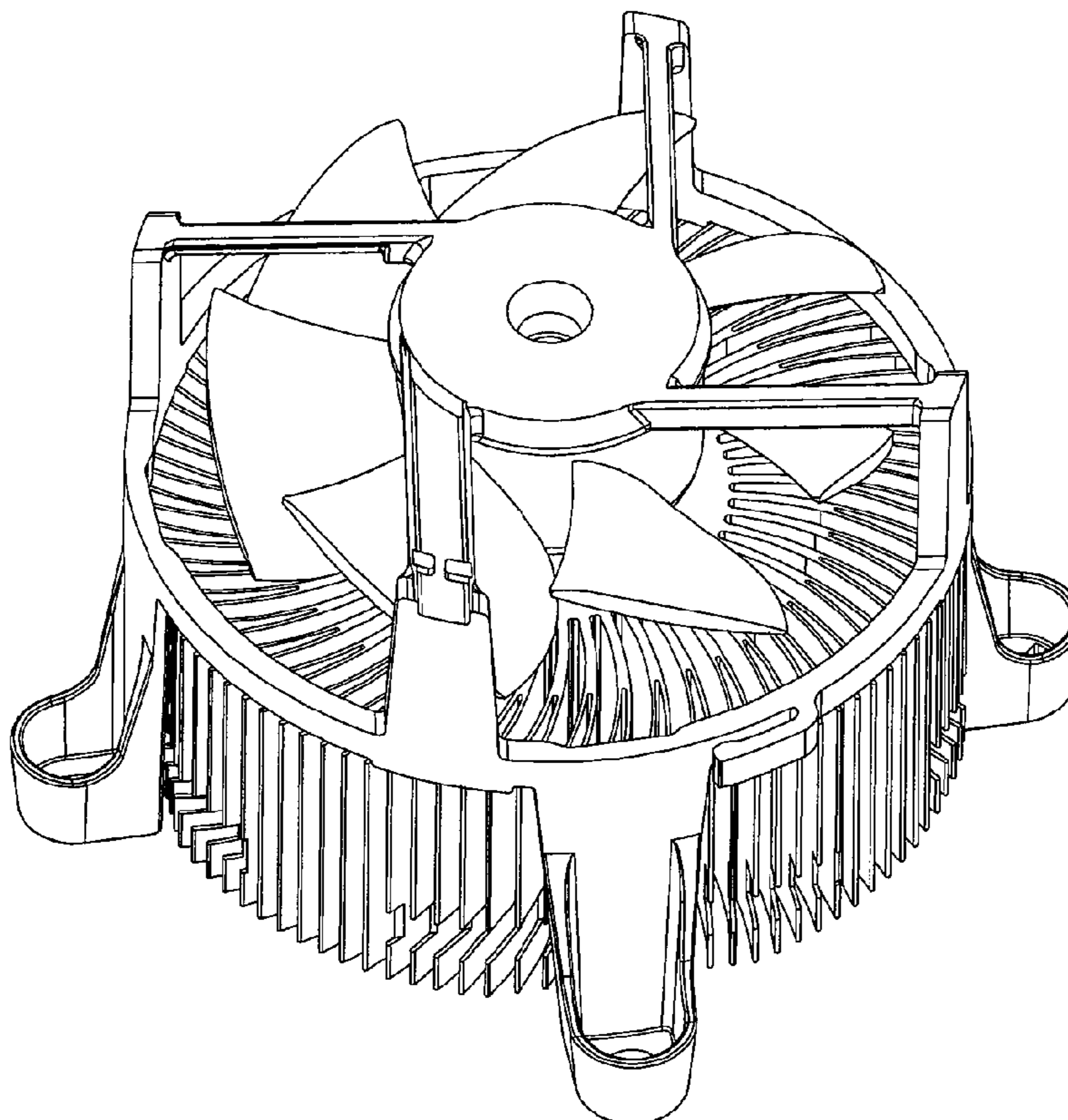

FIG. 1

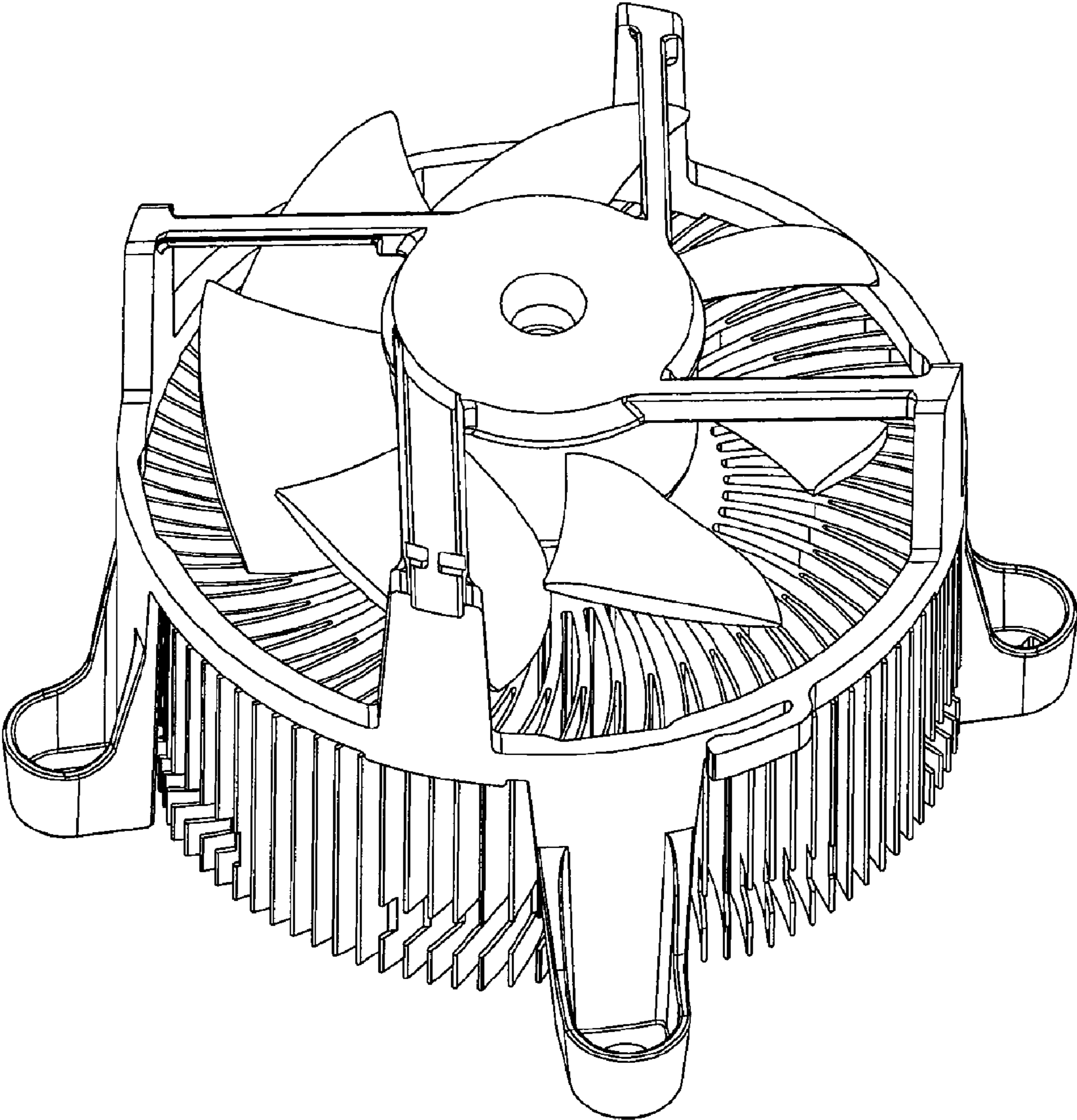

FIG. 2

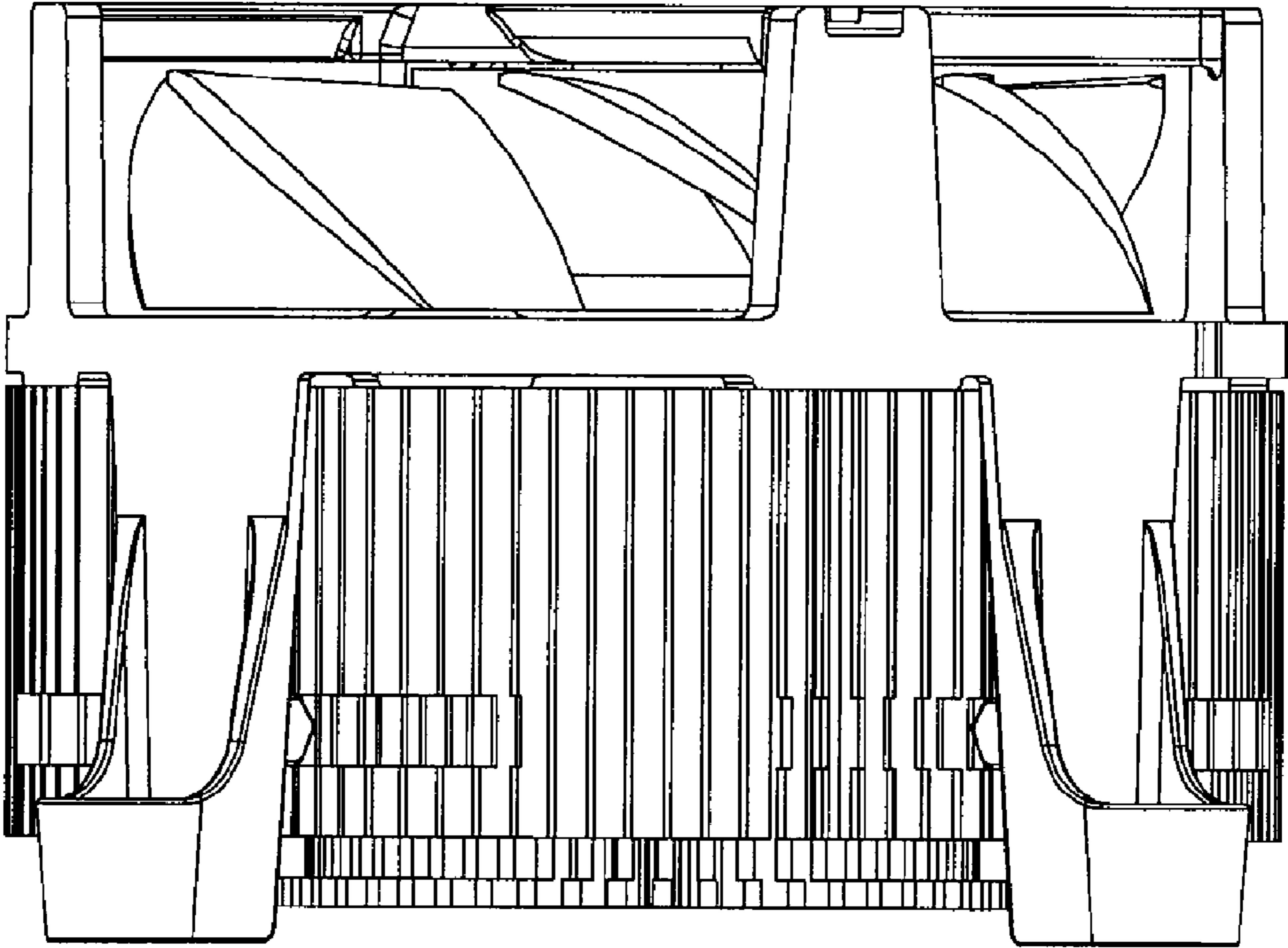

FIG. 3

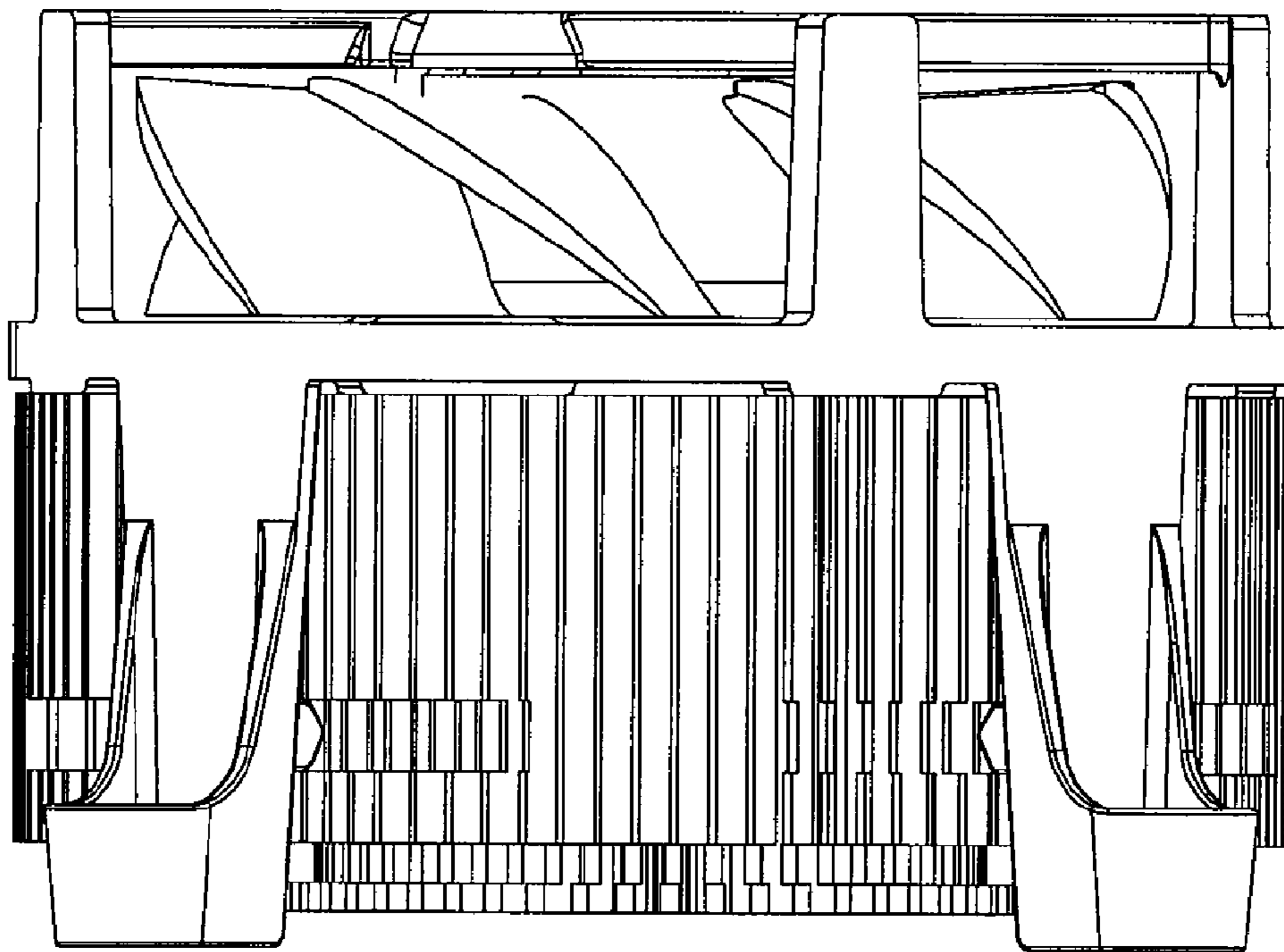

FIG. 4

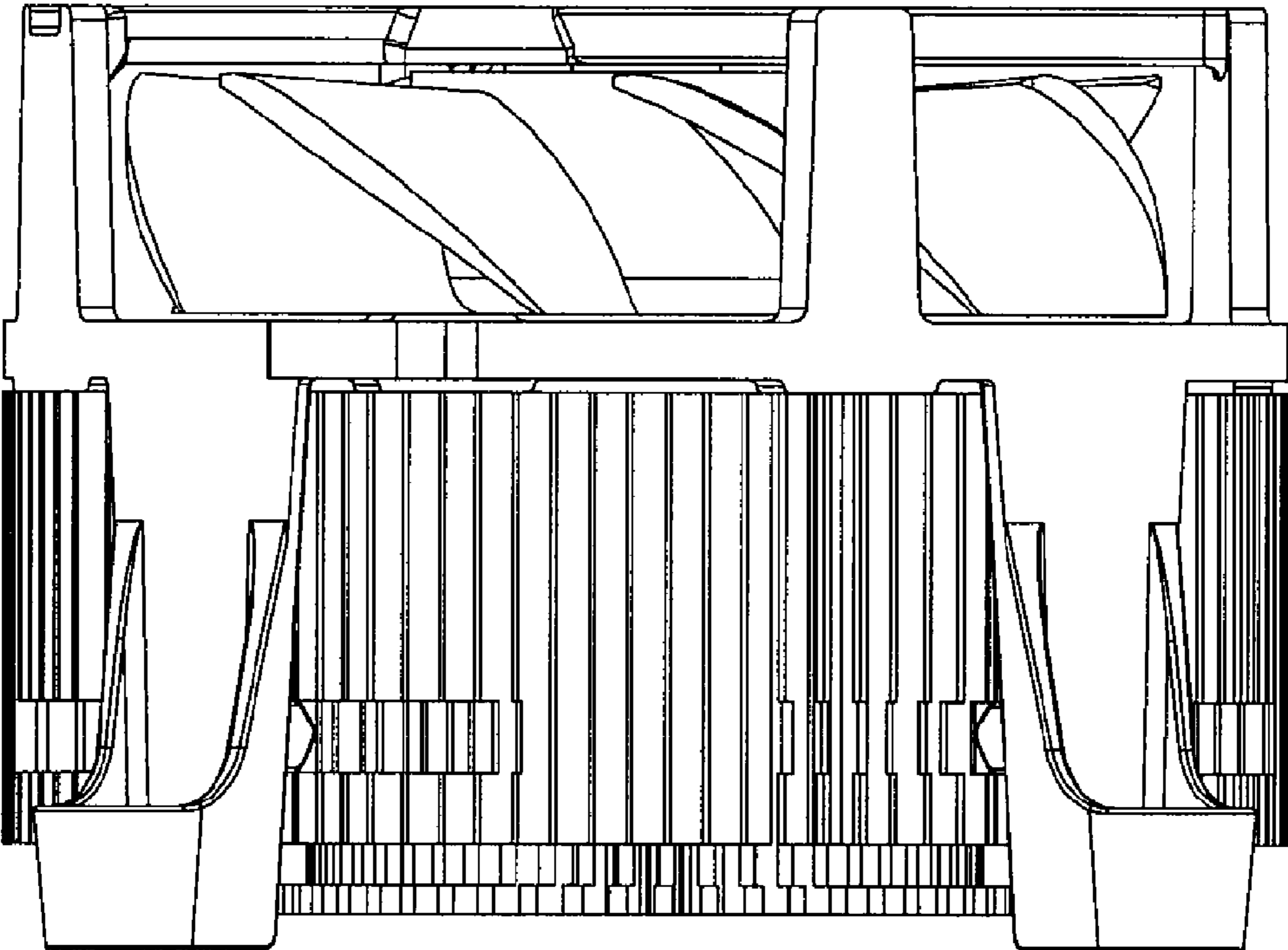

FIG. 5

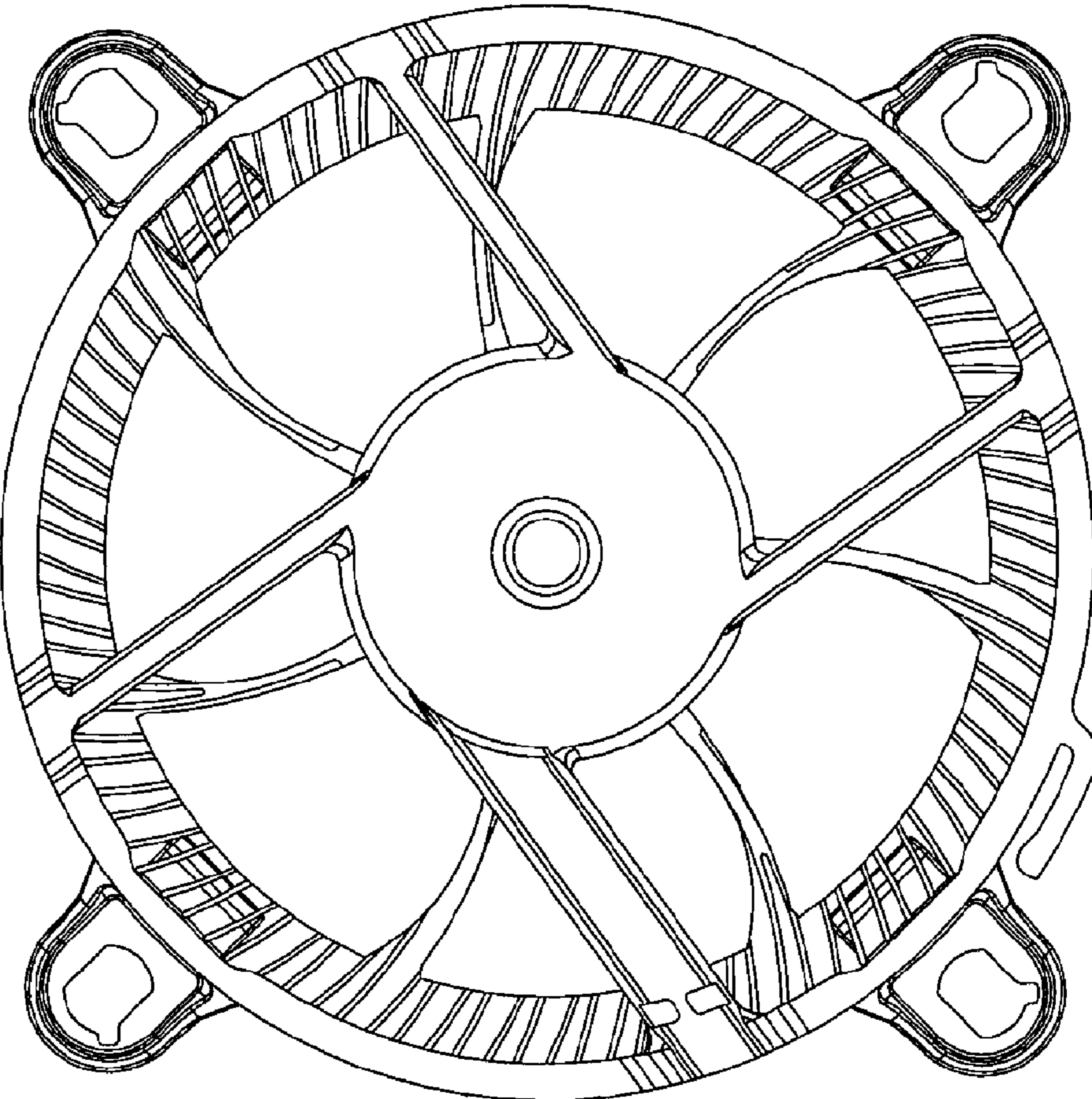

FIG. 6

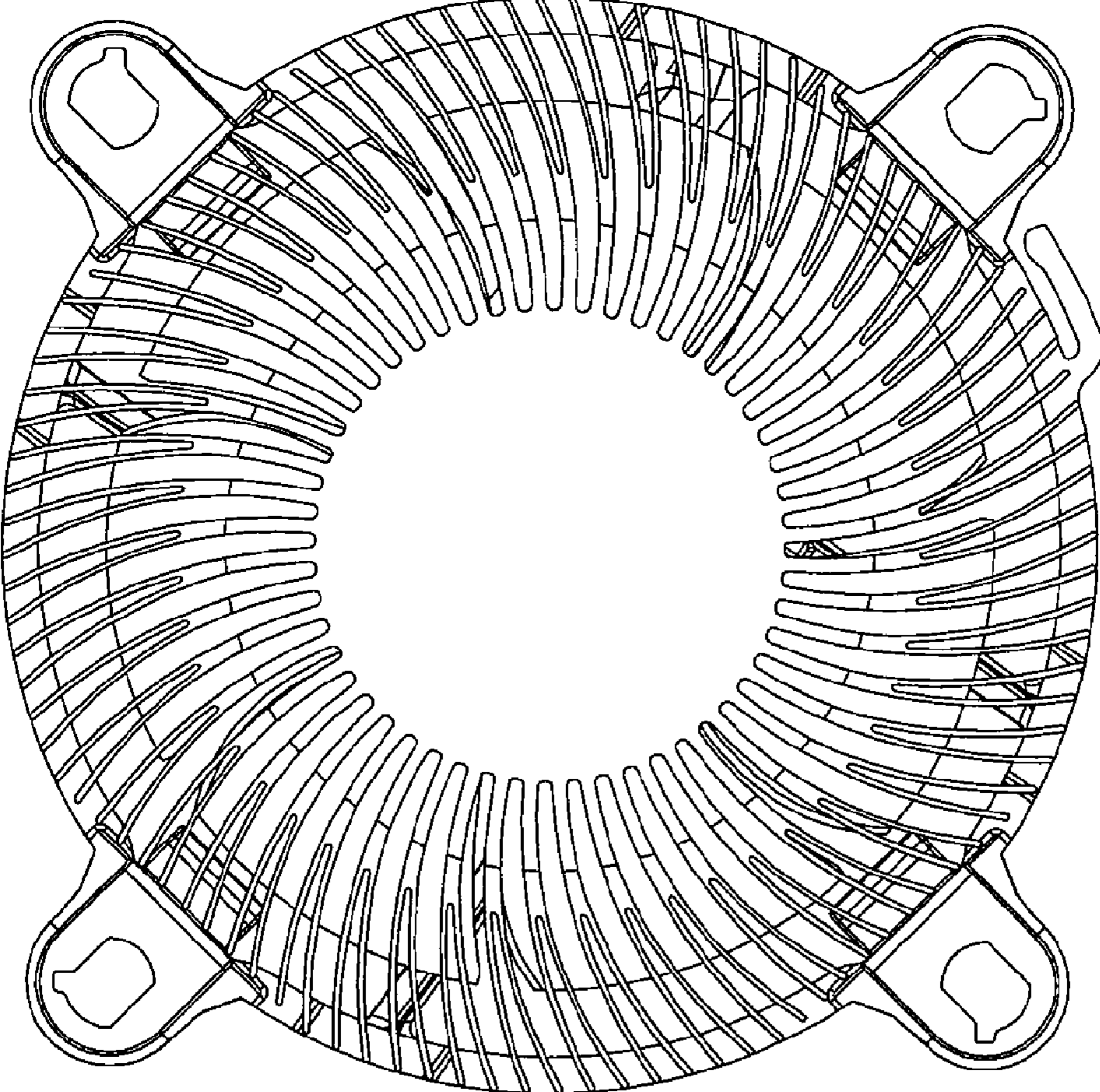

FIG. 7

