



US00D561095S

(12) **United States Design Patent** (10) **Patent No.:** **US D561,095 S**  
**Sakai et al.** (45) **Date of Patent:** **\*\* Feb. 5, 2008**

(54) **INVERTER CONTROLLER**

D457,492 S \* 5/2002 Kim ..... D13/110  
D502,914 S \* 3/2005 Higuchi et al. .... D13/110  
D502,916 S \* 3/2005 Higuchi et al. .... D13/110

(75) Inventors: **Masafumi Sakai**, Kitakyushu (JP);  
**Kenji Isomoto**, Kitakyushu (JP);  
**Shigekatsu Nagatomo**, Kitakyushu  
(JP); **Takayuki Morihara**, Kitakyushu  
(JP)

(73) Assignee: **Kabushiki Kaisha Yaskawa Denki**,  
Fukuoka (JP)

(\*\*) Term: **14 Years**

(21) Appl. No.: **29/278,750**

(22) Filed: **Apr. 9, 2007**

(30) **Foreign Application Priority Data**

Dec. 12, 2006 (JP) ..... D2006-034081

(51) **LOC (8) Cl.** ..... **13-02**

(52) **U.S. Cl.** ..... **D13/110**

(58) **Field of Classification Search** ..... D13/110,  
D13/101, 123, 184, 199; 307/150-152; 361/600,  
361/601, 622, 702, 703, 730, 809; 363/141,  
363/142

See application file for complete search history.

(56) **References Cited**

**U.S. PATENT DOCUMENTS**

4,620,263 A \* 10/1986 Ito ..... 361/690  
D303,370 S \* 9/1989 Kondo et al. .... D13/110  
5,170,336 A \* 12/1992 Getter et al. .... 363/141  
D343,382 S \* 1/1994 Hagura et al. .... D13/110  
D358,753 S \* 5/1995 Yoshida et al. .... D13/123  
5,497,289 A \* 3/1996 Sugishima et al. .... 361/709  
D372,017 S \* 7/1996 Suematsu et al. .... D13/110  
D376,785 S \* 12/1996 Ikeda et al. .... D13/110  
D455,121 S \* 4/2002 Takeuchi et al. .... D13/110  
D455,399 S \* 4/2002 Imamura et al. .... D13/110  
D455,714 S \* 4/2002 Kim ..... D13/110

**OTHER PUBLICATIONS**

News Release, Kabushiki Kaisha Yaskawa Denki, Nov. 13, 2006,  
<http://www.yaskawa.co.jp/newsrelease/2006/15.htm>.

Newspaper Article, Denpa Shinbun, p. 6, Nov. 16, 2006.

Rotor, Kabushiki Kaisha Yaskawa Denki, vol. 263, pp. 18-21, Nov.  
30, 2006.

Catalog, Yaskawa Inverter V1000, Nov. 2006.

\* cited by examiner

*Primary Examiner*—Prabhakar Deshmukh

*Assistant Examiner*—Derrick Holland

(74) *Attorney, Agent, or Firm*—Westerman, Hattori, Daniels  
& Adrian, LLP.

(57) **CLAIM**

The ornamental design for an inverter controller, as shown  
and described.

**DESCRIPTION**

FIG. 1 is a front elevation view of an inverter controller  
showing our new design;

FIG. 2 is a rear elevation view thereof;

FIG. 3 is a left side elevation view thereof;

FIG. 4 is a right side elevation view thereof;

FIG. 5 is a top plan view thereof;

FIG. 6 is a bottom plan view thereof;

FIG. 7 is a perspective view thereof; and,

FIG. 8 is a perspective view showing the inverter controller  
in use being connected to a motor by an output cable.

The broken lines show environmental structure only, and are  
not a part of the design sought to be patented.

**1 Claim, 5 Drawing Sheets**

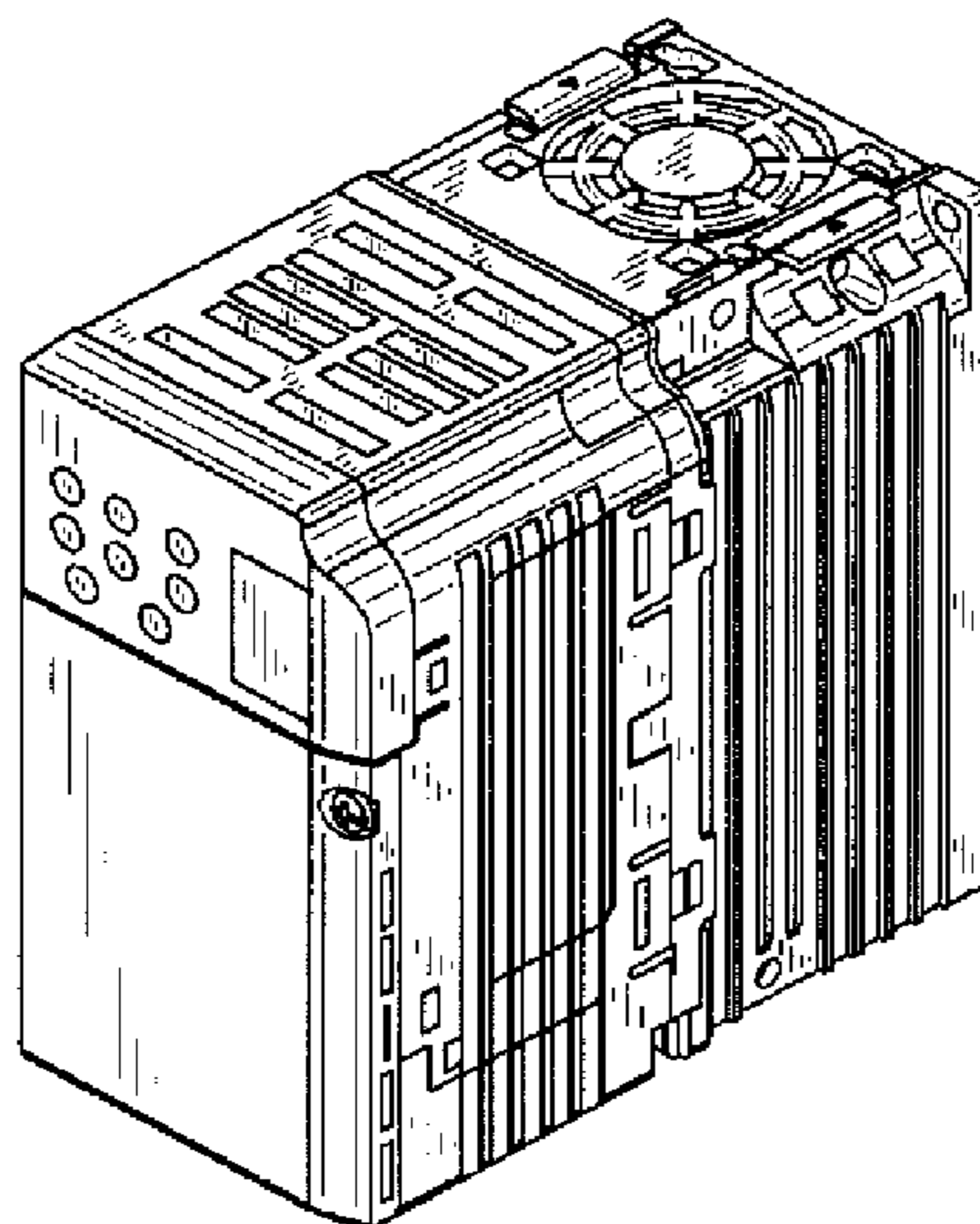

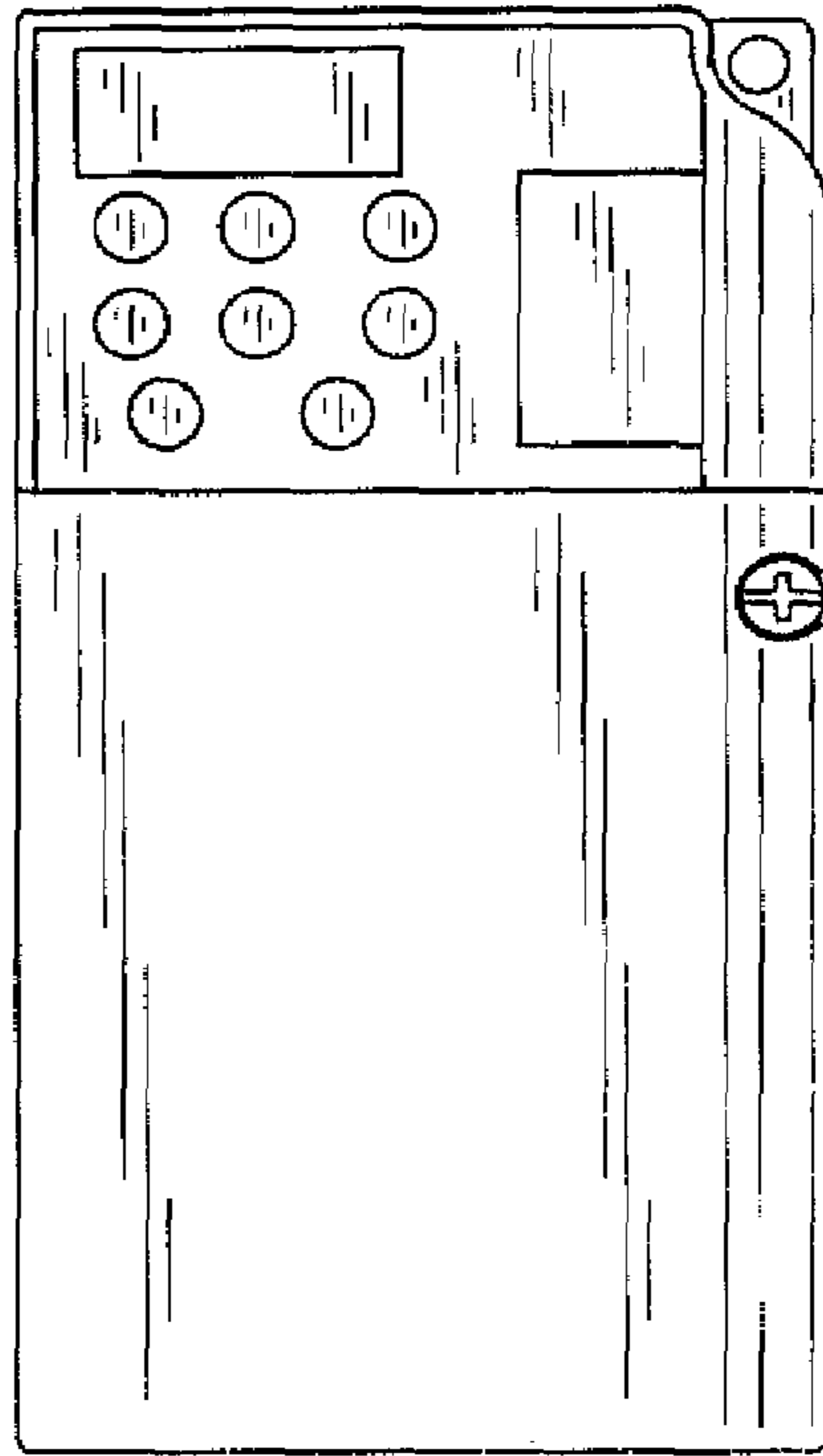

FIG. 1

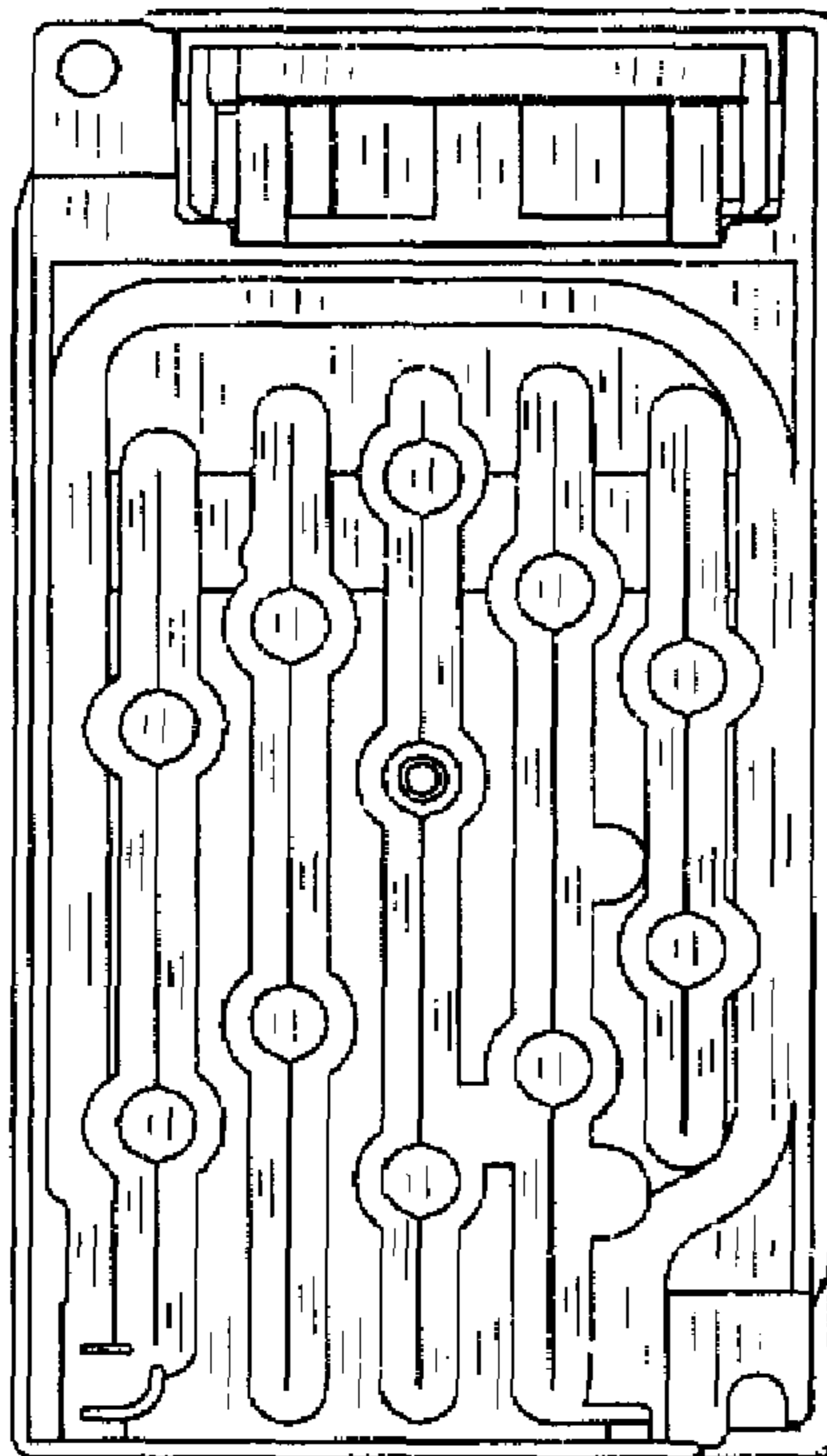

FIG. 2

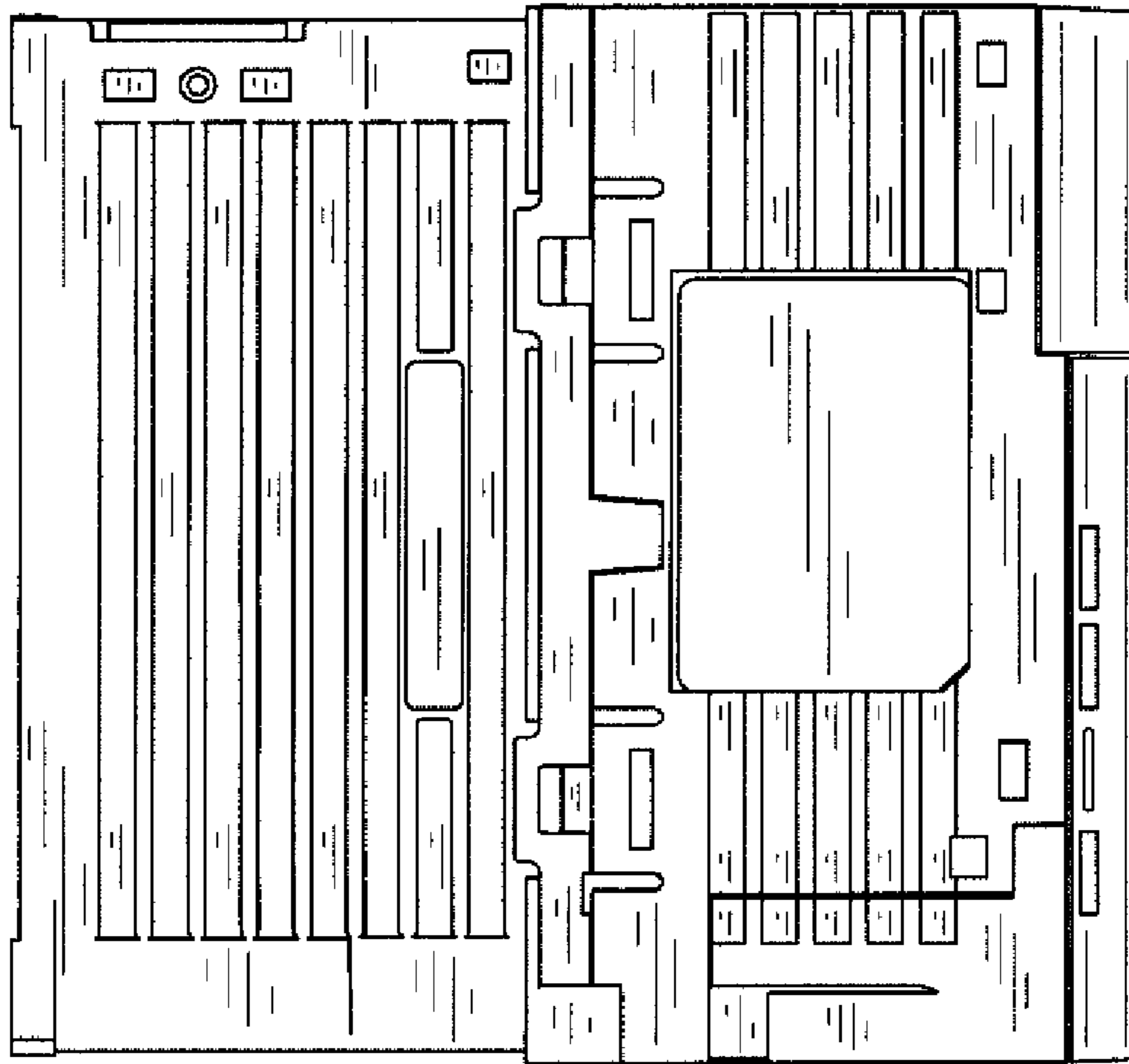

FIG. 3

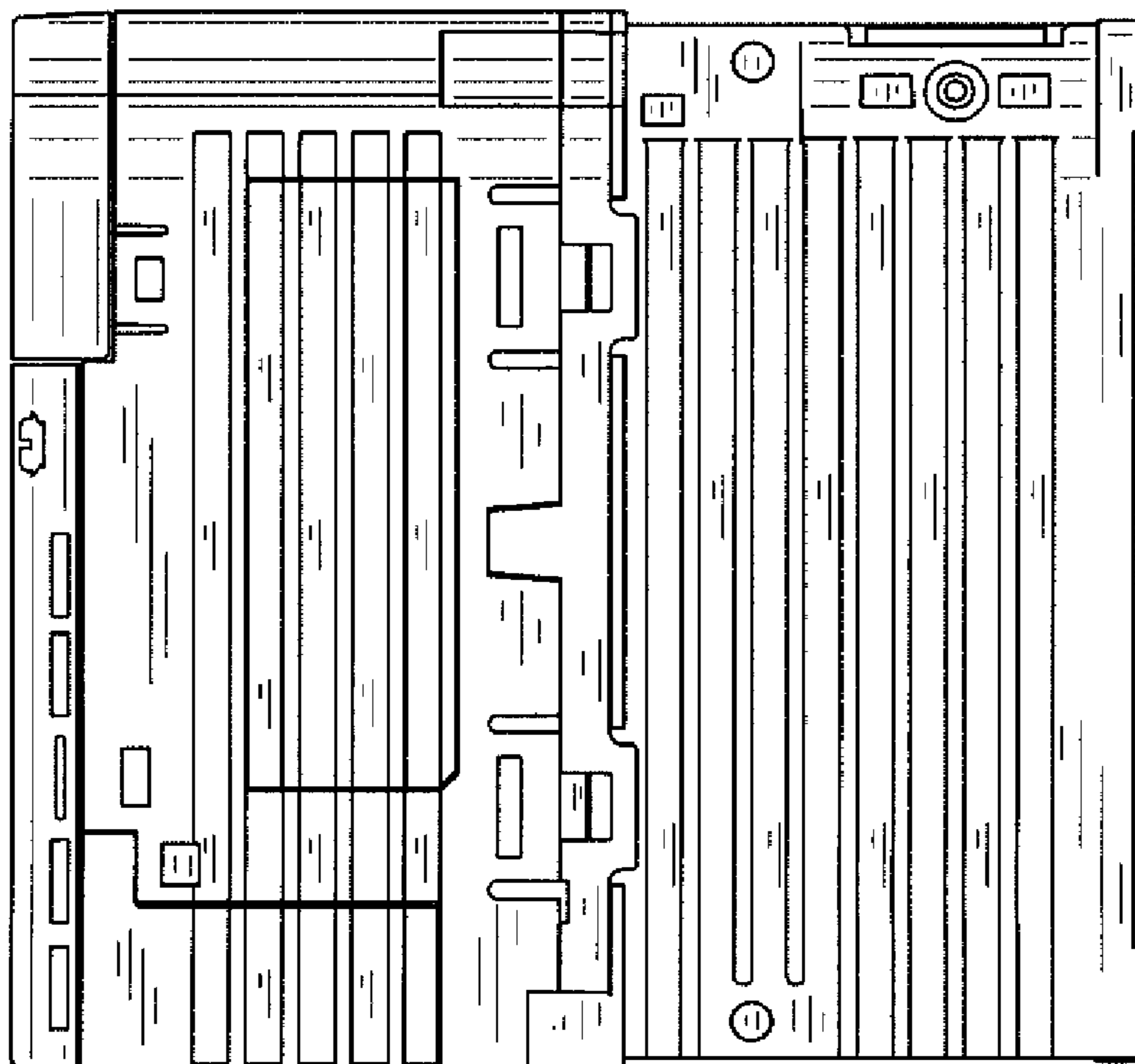

FIG. 4

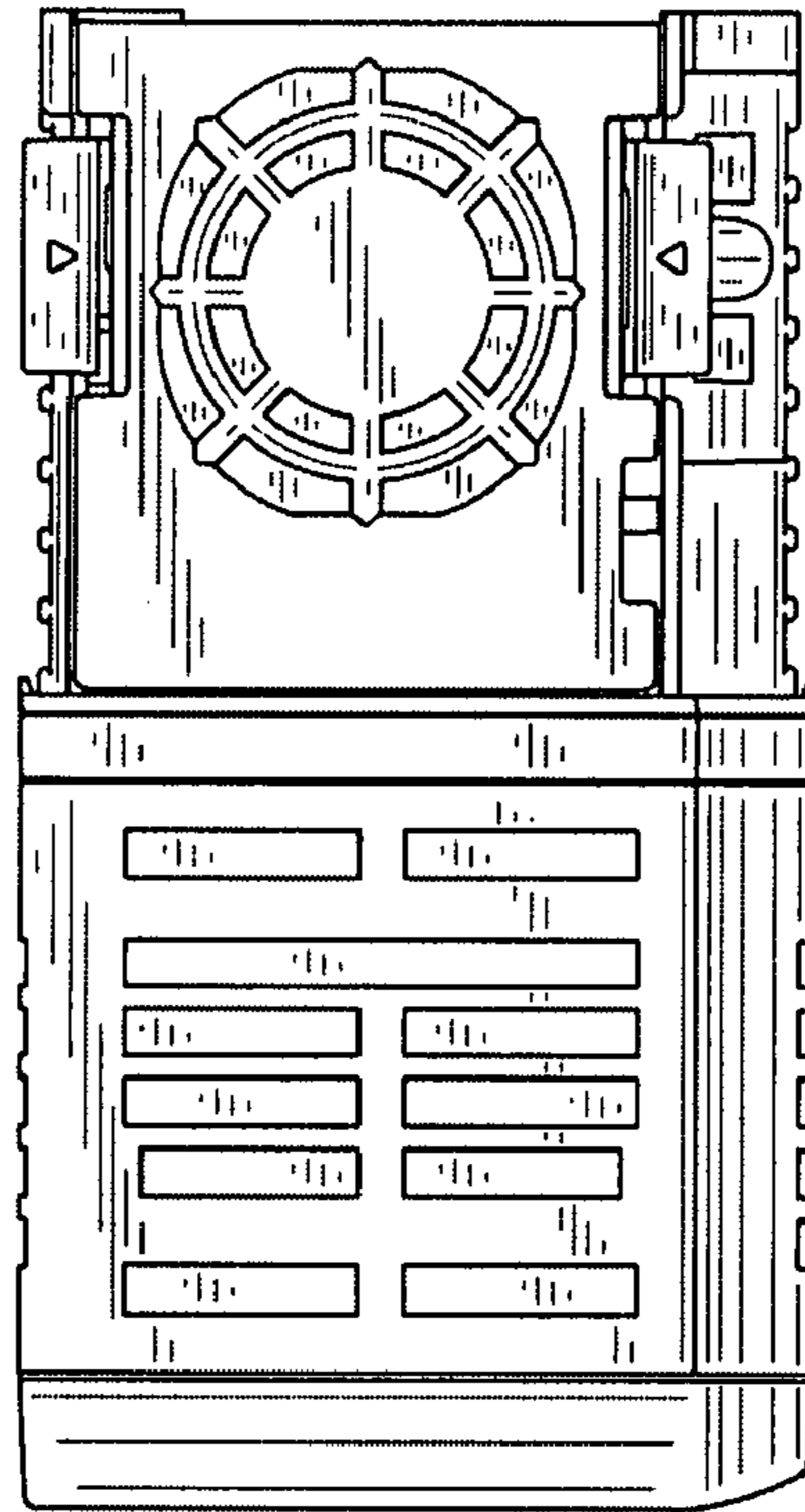

FIG. 5

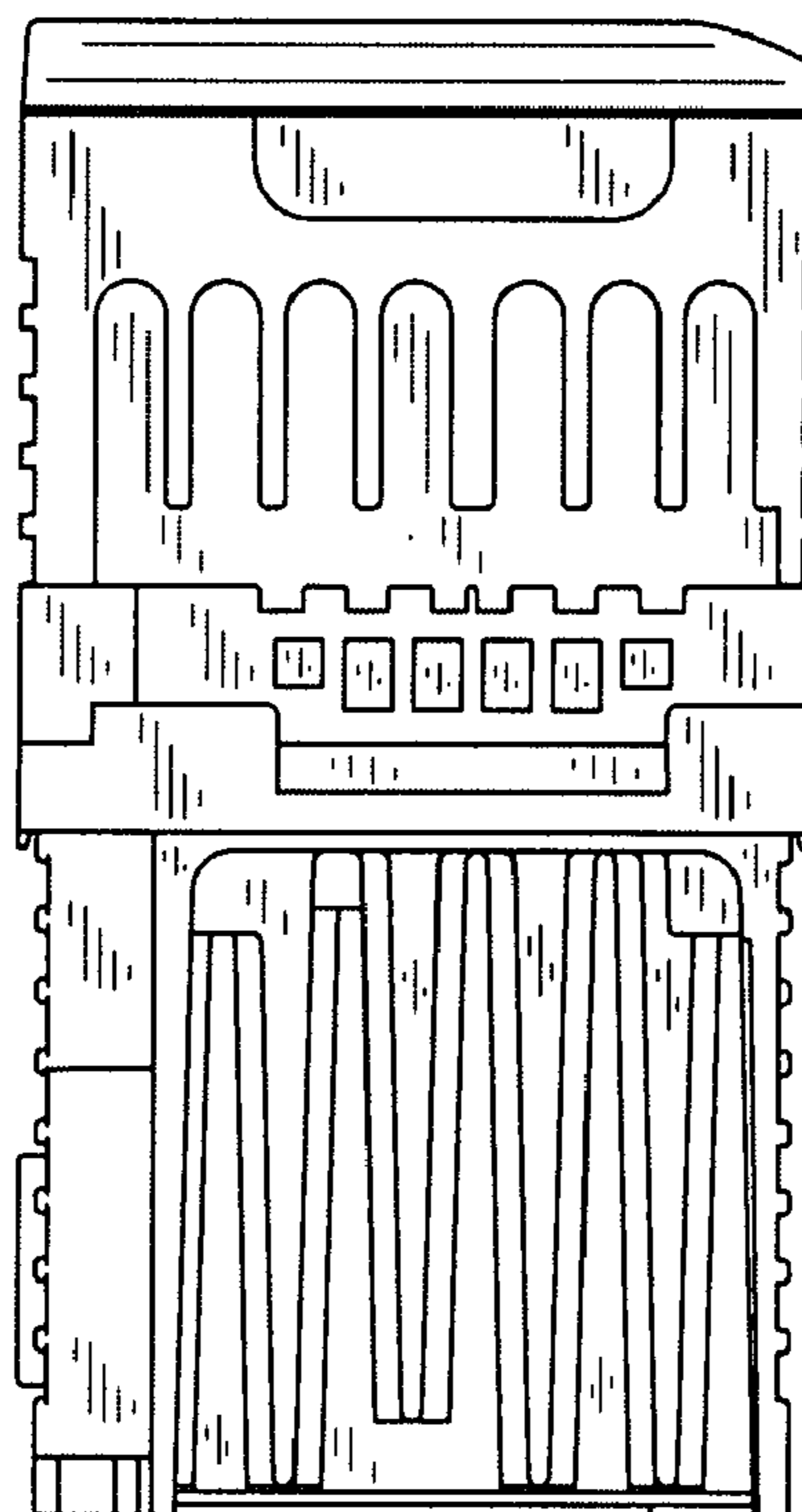

FIG. 6

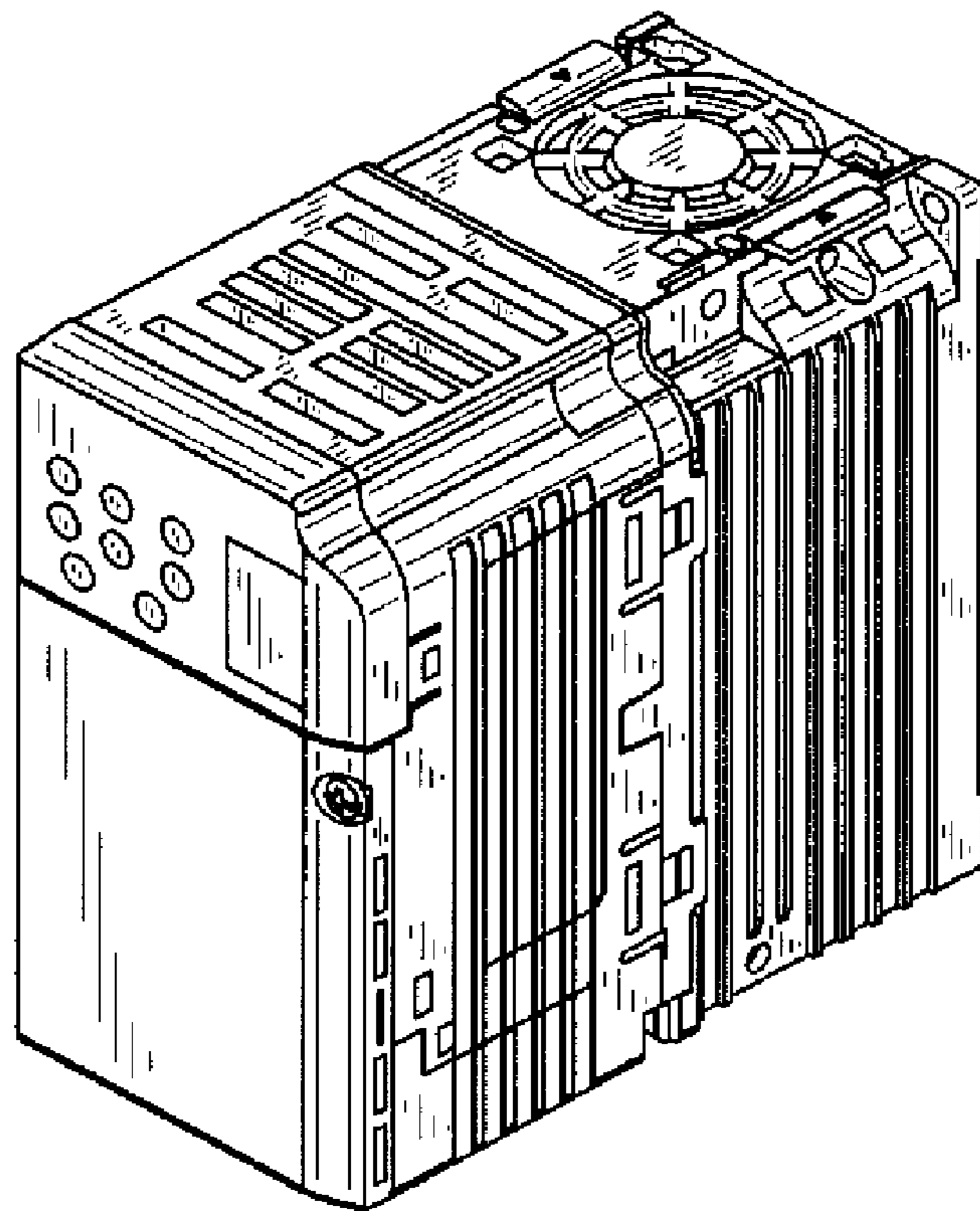

FIG. 7

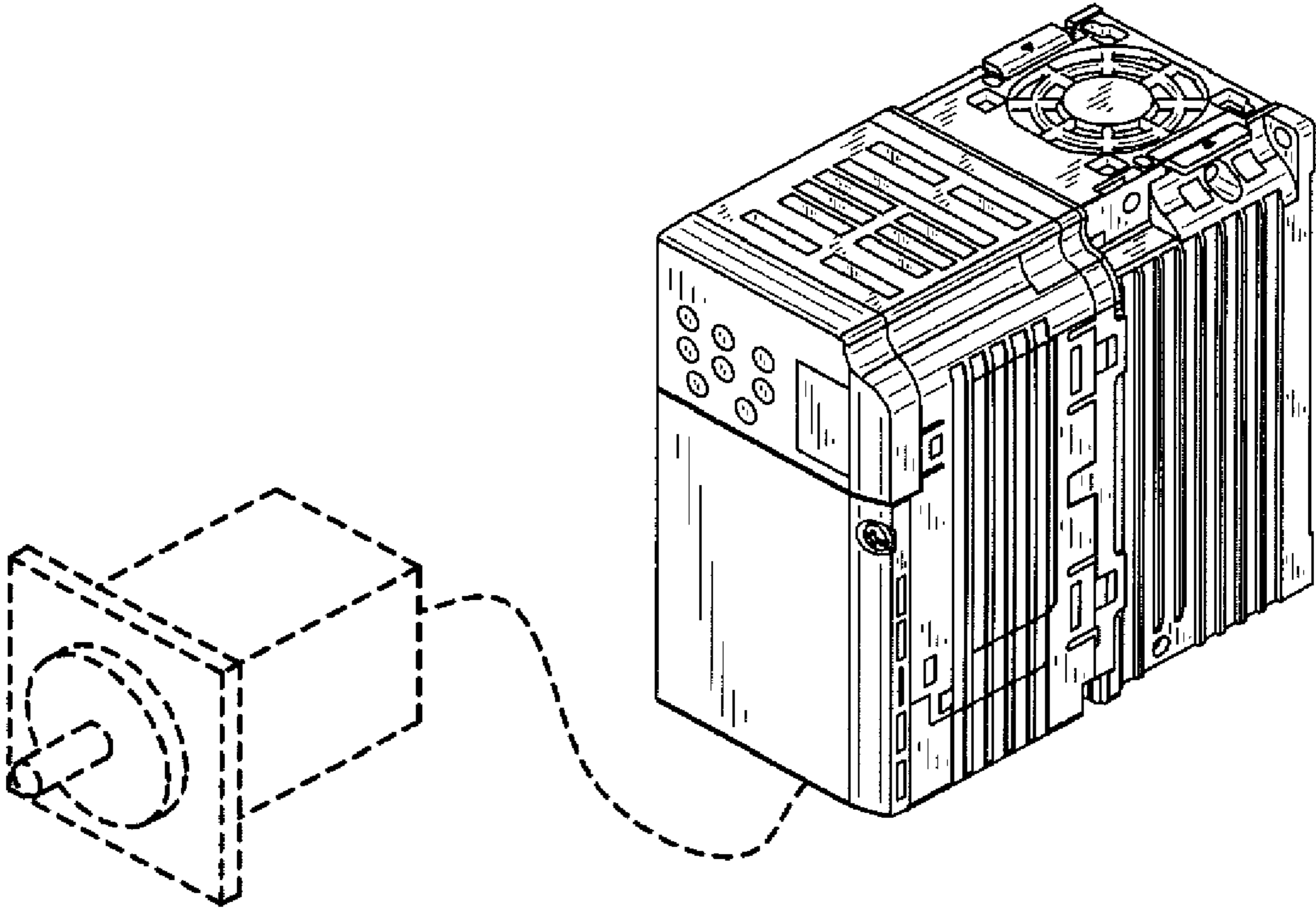

FIG. 8