



US00D561071S

(12) **United States Design Patent** (10) **Patent No.:** **US D561,071 S**
Golden et al. (45) **Date of Patent:** **** Feb. 5, 2008**

(54) **VEHICLE REAR BUMPER COVER**

(74) *Attorney, Agent, or Firm*—Damian Porcari

(75) Inventors: **Edward Golden**, Pinckney, MI (US);
George Bucher, Dearborn, MI (US);
David Mahoney, Orchard Lake, MI
(US); **Michael Webb**, Harrison
Township, MI (US)

(57) **CLAIM**

The ornamental design for a vehicle rear bumper cover, as shown and described.

(73) Assignee: **Ford Global Technologies, LLC**,
Dearborn, MI (US)

DESCRIPTION

(**) Term: **14 Years**

FIG. 1 is a front elevational view of a vehicle rear bumper cover showing our new design;

(21) Appl. No.: **29/250,324**

FIG. 2 is an enlarged right side elevational view thereof;

(22) Filed: **Nov. 10, 2006**

FIG. 3 is an enlarged left side elevational view thereof;

(51) **LOC (8) Cl.** **12-16**

FIG. 4 is a top plan view thereof;

(52) **U.S. Cl.** **D12/169**

FIG. 5 is a bottom plan view thereof;

(58) **Field of Classification Search** D12/90-92,
D12/86, 169, 196, 163; 296/193.1, 181.1;
293/102, 113, 115, 117, 120
See application file for complete search history.

FIG. 6 is a cross sectional view taken along the line 6—6 in FIG. 1; and,

FIG. 7 is a rear elevational view thereof.

The circular members shown in broken lines in FIGS. 1, 2, 3 and 5 are for illustrative purposes only and form no part of the claimed design.

(56) **References Cited**

U.S. PATENT DOCUMENTS

D511,725 S * 11/2005 Nagashima D12/169
D529,846 S * 10/2006 Konaka D12/169
D533,818 S * 12/2006 Kitazumi et al. D12/169
D546,249 S * 7/2007 Markefka D12/169

The vehicle rear bumper cover is styled independently of adjacent vehicle panels. To the extent that any feature lines are illustrated, they are intended to illustrate the crest and valley of the feature and are not necessarily sharp bends in the part. Shading is used to illustrate the curvature of the part and not color. Areas shown in or sounded by phantom lines are not claimed. The surface normally visible when the vehicle rear bumper cover is attached to a vehicle is called the “Class A” surface is claimed. The surface not normally visible when the vehicle rear bumper cover is attached to a vehicle is called the “Class B” surface and is not claimed. Any functional features of the vehicle rear bumper cover are not claimed.

OTHER PUBLICATIONS

Winding Road for Drivers, Oct. 2006, <http://news.windingroad.com/auto-news/ford-still-says-this-car-doesnt-exist-2009-mercury-monticello-spied/>.

Ford Freestyle Limited, Chicago 2004 (14 views).

* cited by examiner

Primary Examiner—Melody N. Brown

1 Claim, 7 Drawing Sheets

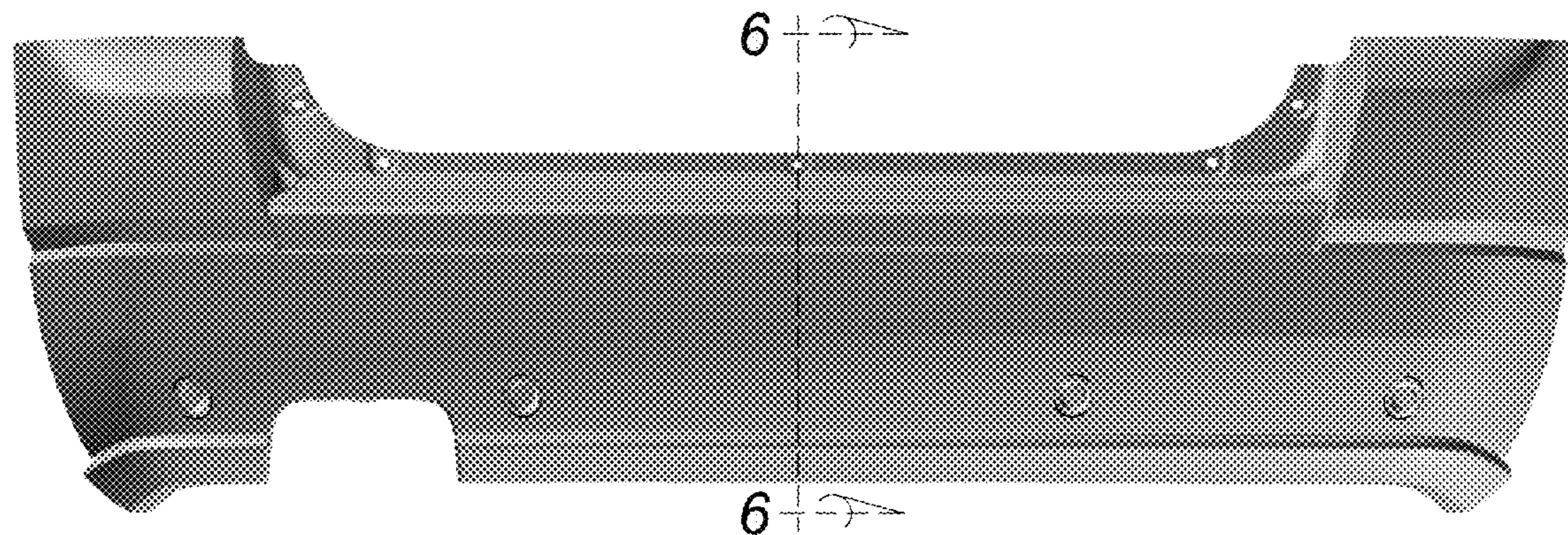

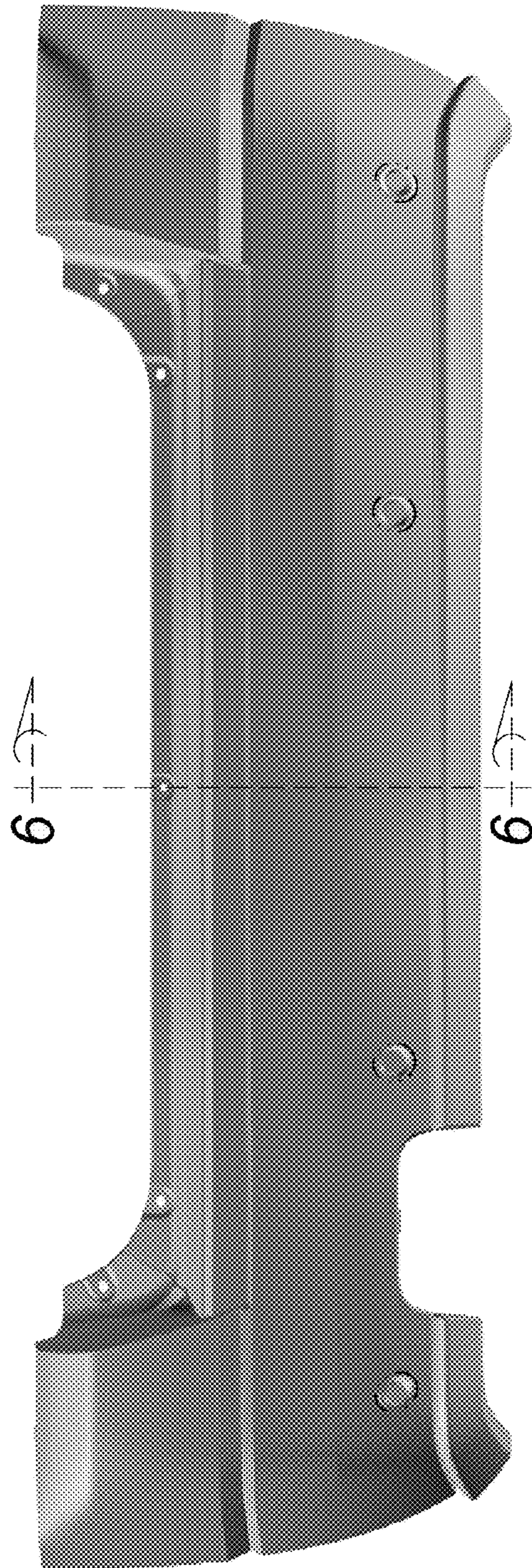

Figure 1

Figure 2



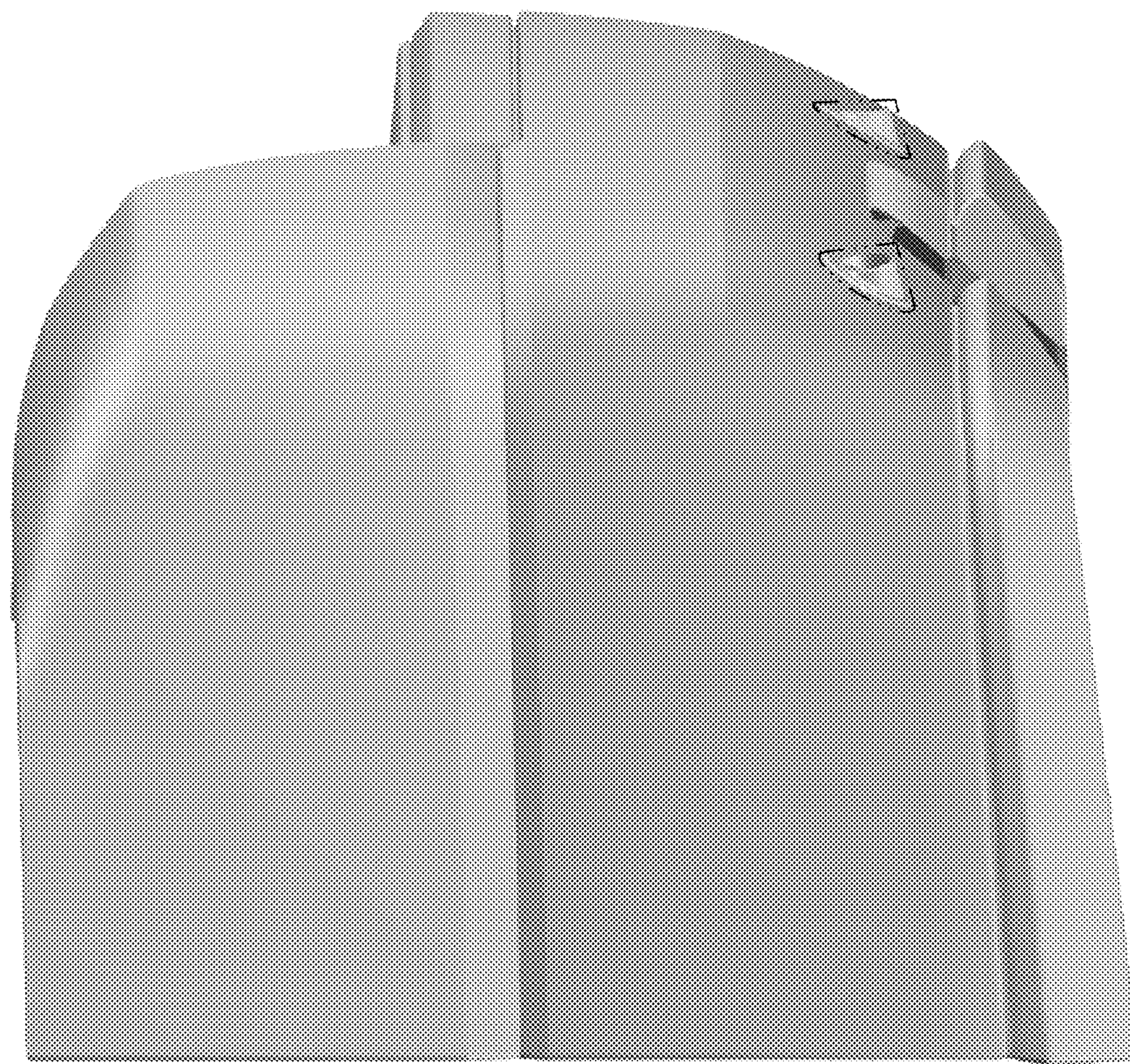

Figure 3

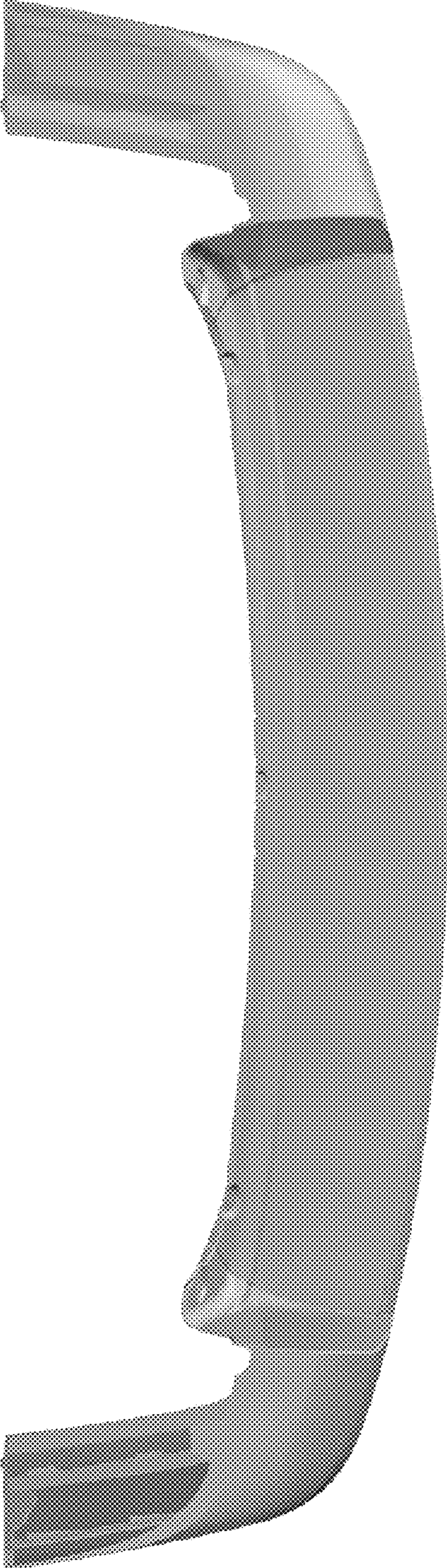

Figure 4

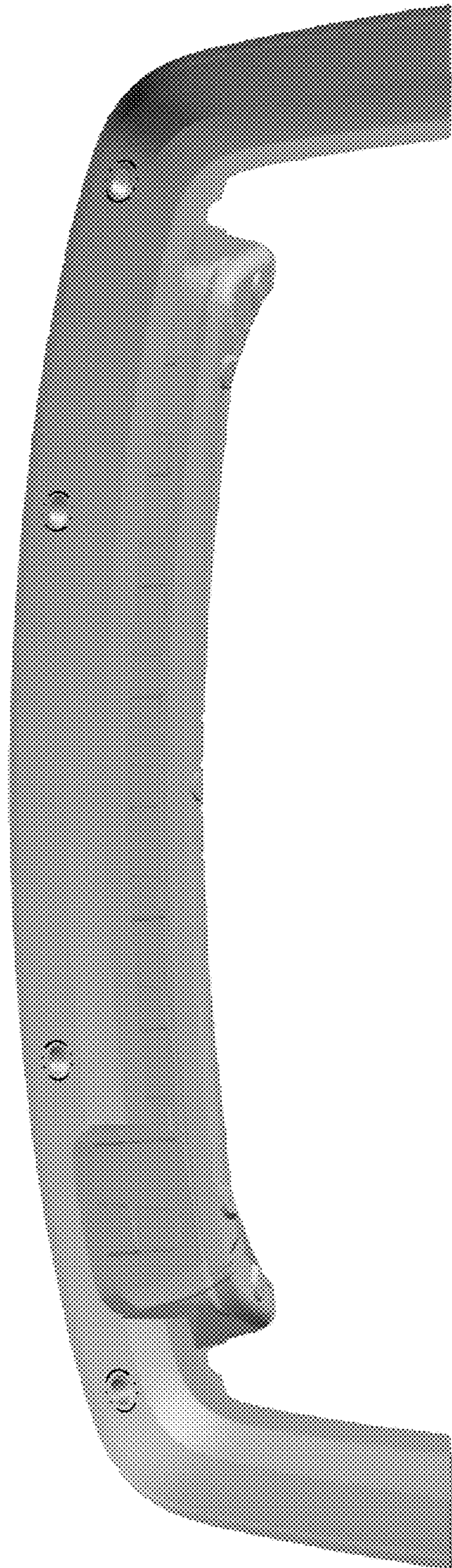

Figure 5

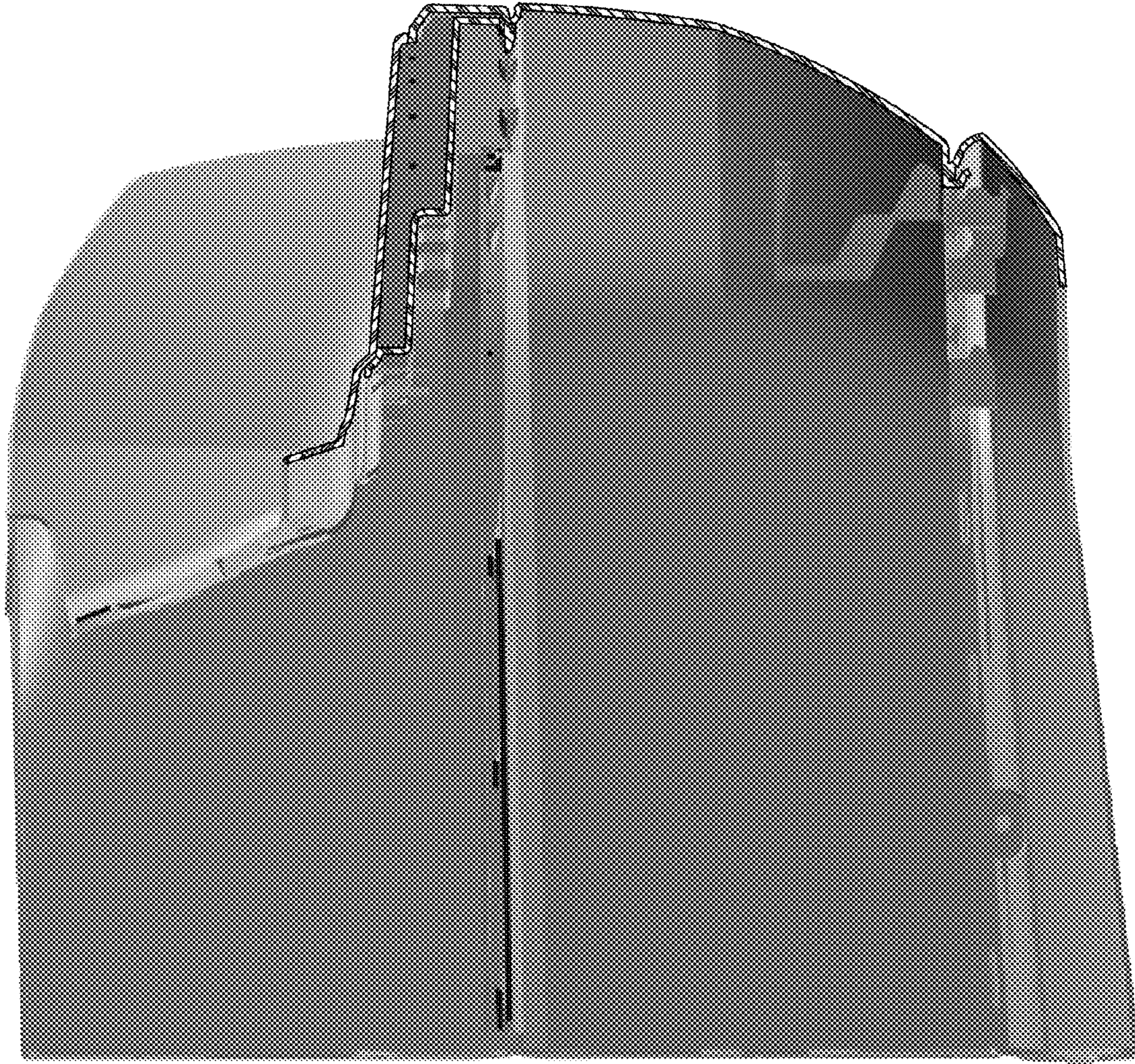

Figure 6

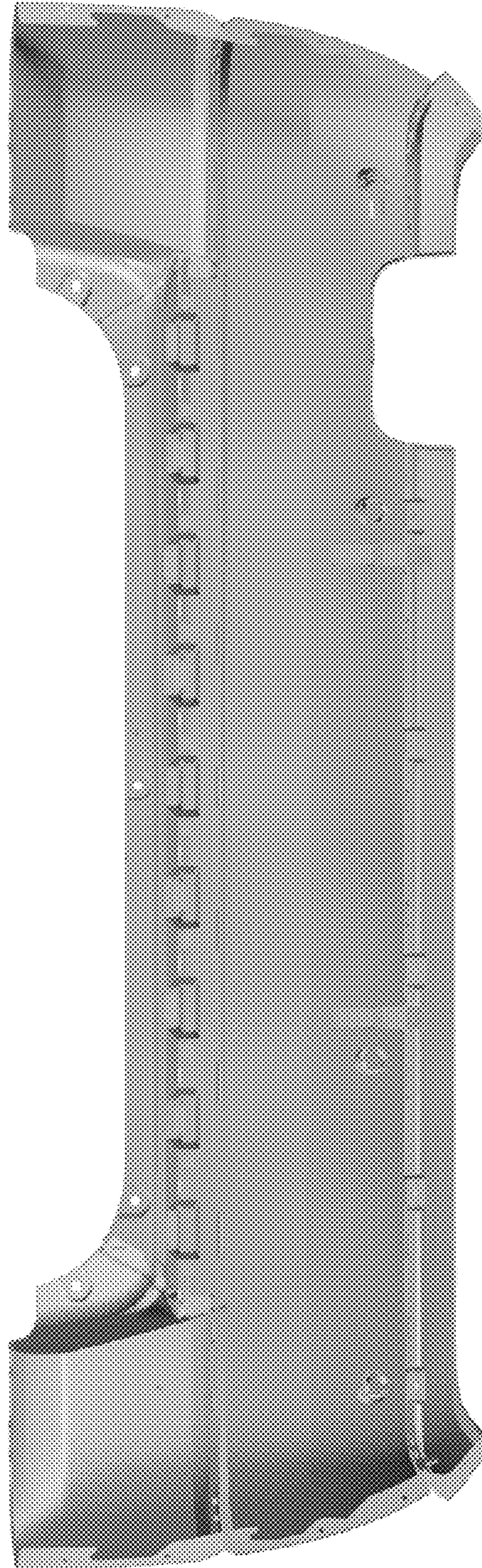

Figure 7