

US00D560922S

(12) **United States Design Patent**
Rope

(10) **Patent No.:** **US D560,922 S**

(45) **Date of Patent:** **** Feb. 5, 2008**

(54) **BED**
(76) **Inventor:** **Edward Dean Rope**, 72A Boakes
Road, Mt Wellington, Auckland (NZ)

D316,939 S * 5/1991 Chambers, Jr. D6/382
D327,984 S * 7/1992 Harris D6/335
D387,576 S * 12/1997 Tilley D6/384
D444,643 S * 7/2001 Bernes D6/388

(**) **Term:** **14 Years**

* cited by examiner

(21) **Appl. No.:** **29/270,362**

Primary Examiner—Janice E. Seeger
(74) *Attorney, Agent, or Firm*—Young & Thompson

(22) **Filed:** **Dec. 21, 2006**

(57) **CLAIM**

(30) **Foreign Application Priority Data**

The ornamental design for a bed, as shown.

Jun. 22, 2006 (NZ) 407722

DESCRIPTION

(51) **LOC (8) Cl.** **06-01**

FIG. 1 is a top, side and end perspective view of a bed showing my new design;

(52) **U.S. Cl.** **D6/388**; 393/335

FIG. 2 is a top plan view thereof;

(58) **Field of Classification Search** D6/382–384,
D6/388, 389, 393–395, 505–508, 345, 358,
D6/334, 335, 337, 361, 381; 5/53.1, 279.1,
5/280.281, 12.2, 907, 705

FIG. 3 is a bottom plan view thereof;

See application file for complete search history.

FIG. 4 is a left side elevational view thereof;

FIG. 5 is a front elevational view thereof;

(56) **References Cited**

FIG. 6 is a right side elevational view thereof; and,

U.S. PATENT DOCUMENTS

FIG. 7 is a rear elevational view thereof.

D218,889 S * 10/1970 Lamb D6/361

1 Claim, 2 Drawing Sheets

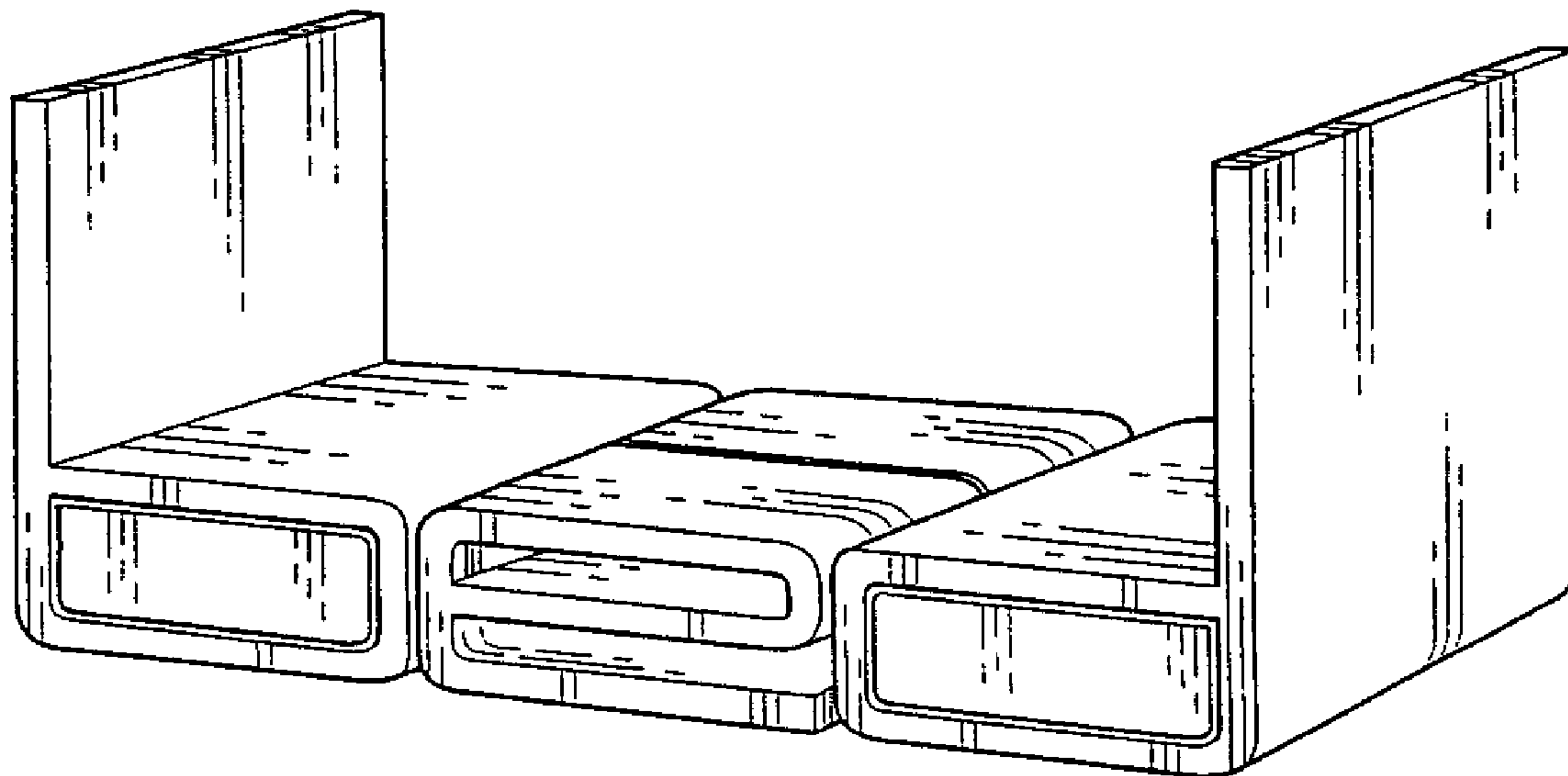

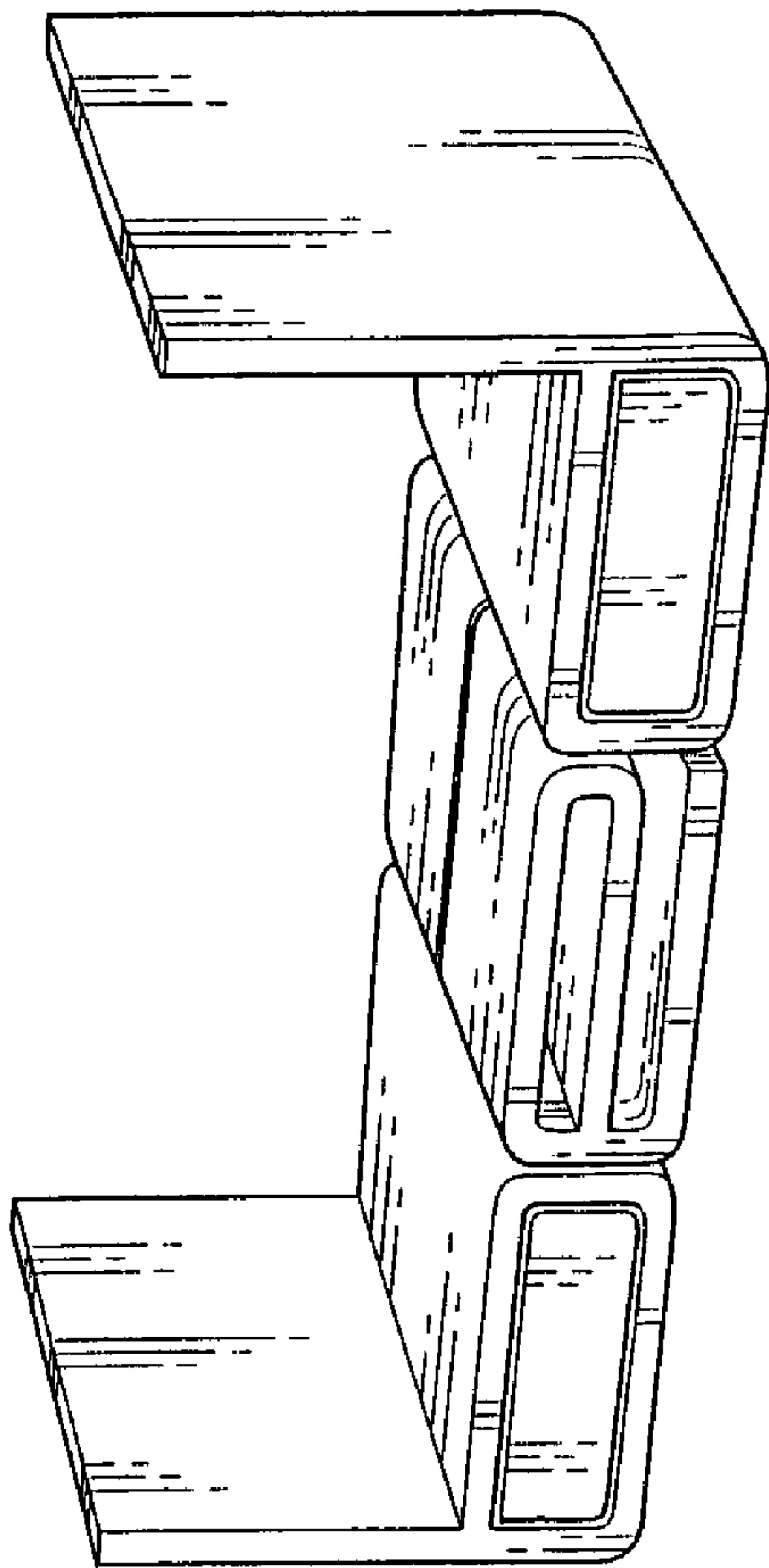

FIGURE 1

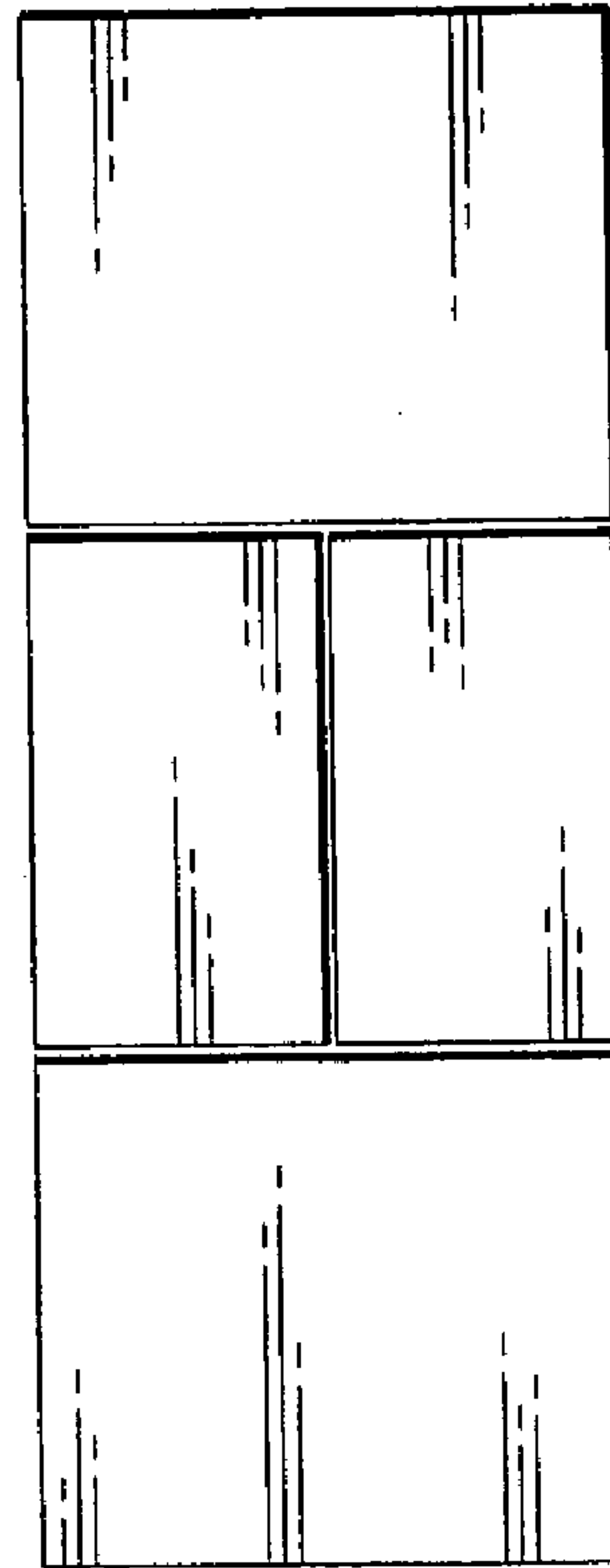

FIGURE 3

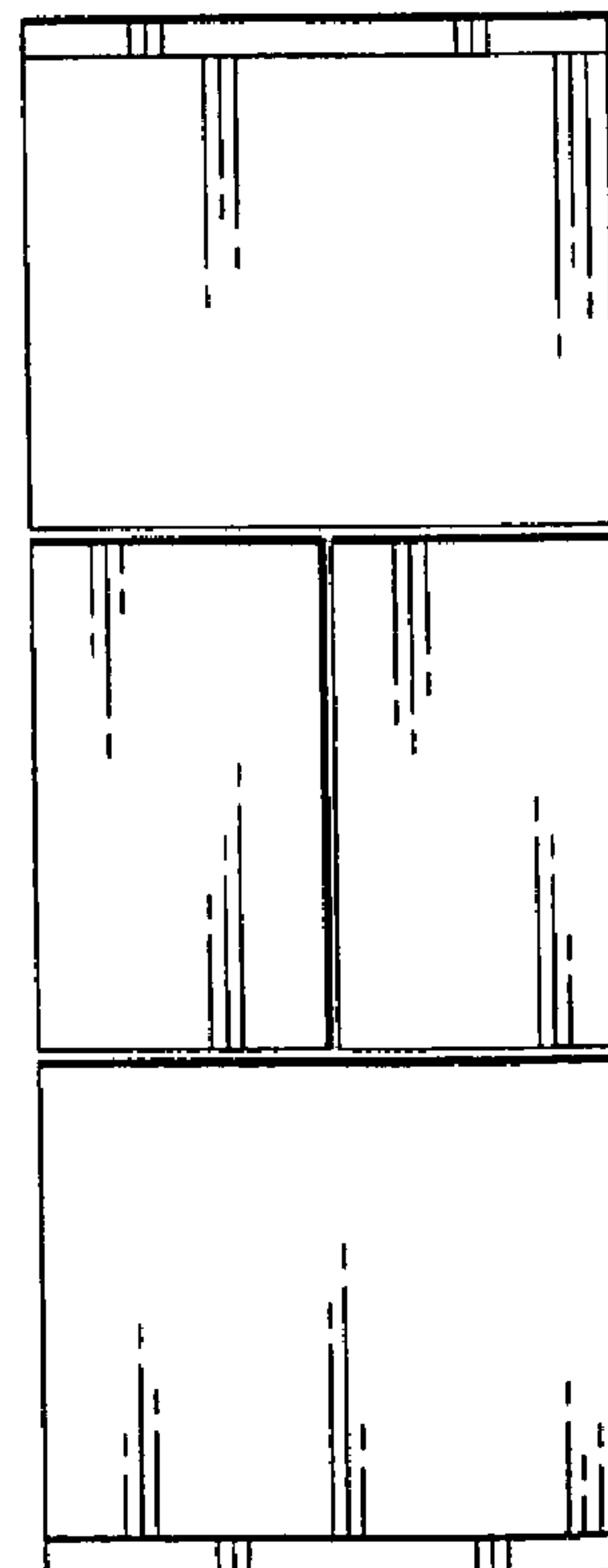

FIGURE 2

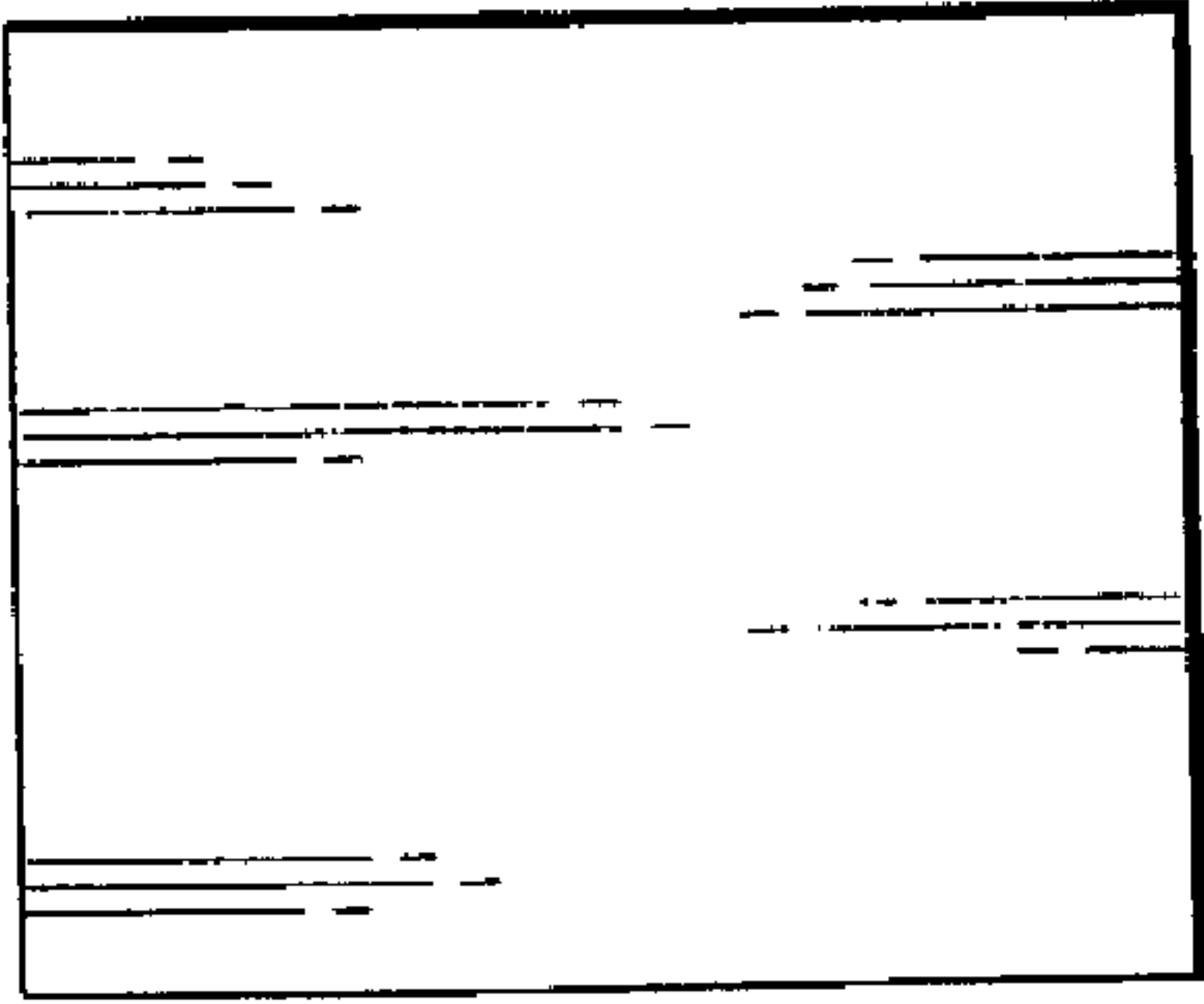

FIGURE 5

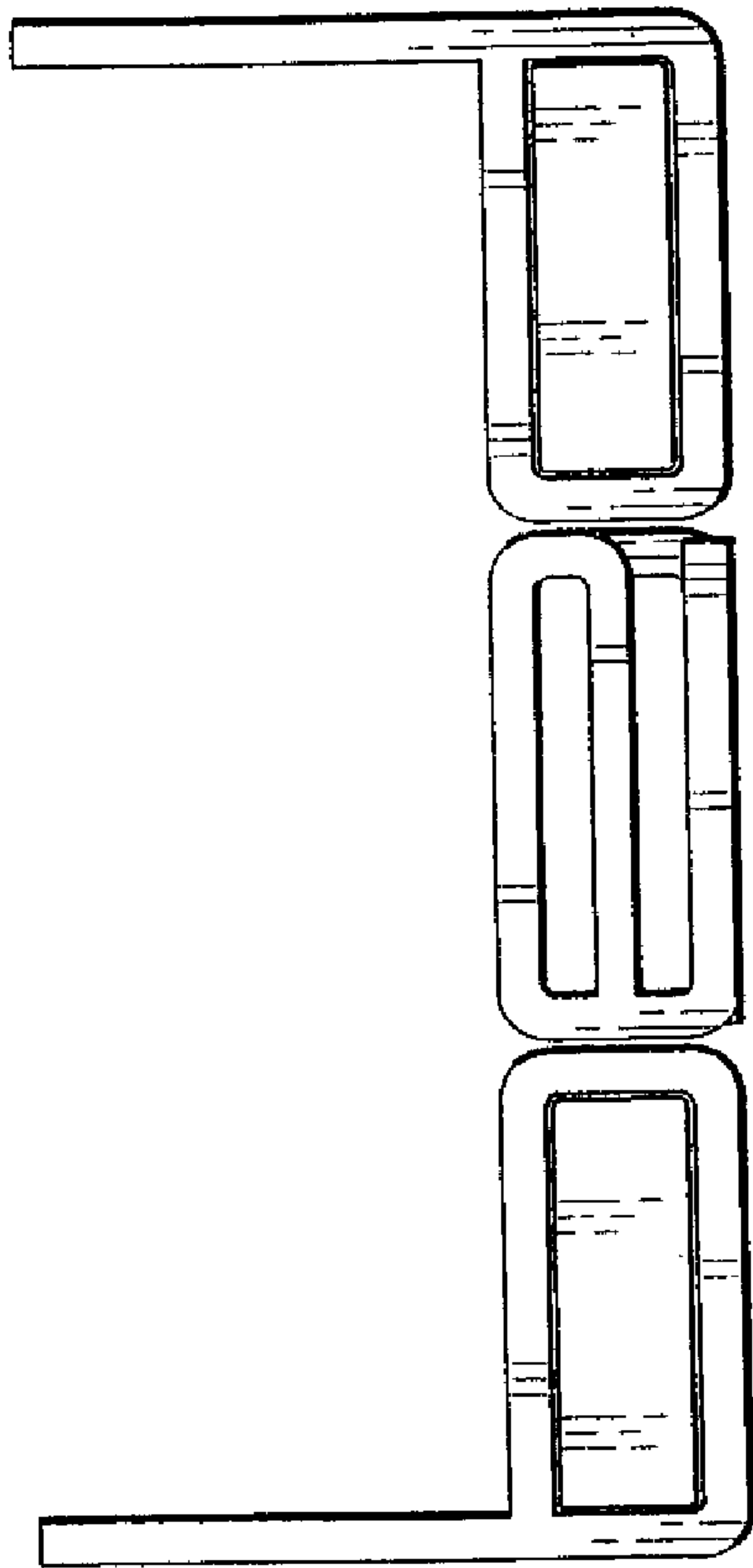

FIGURE 6

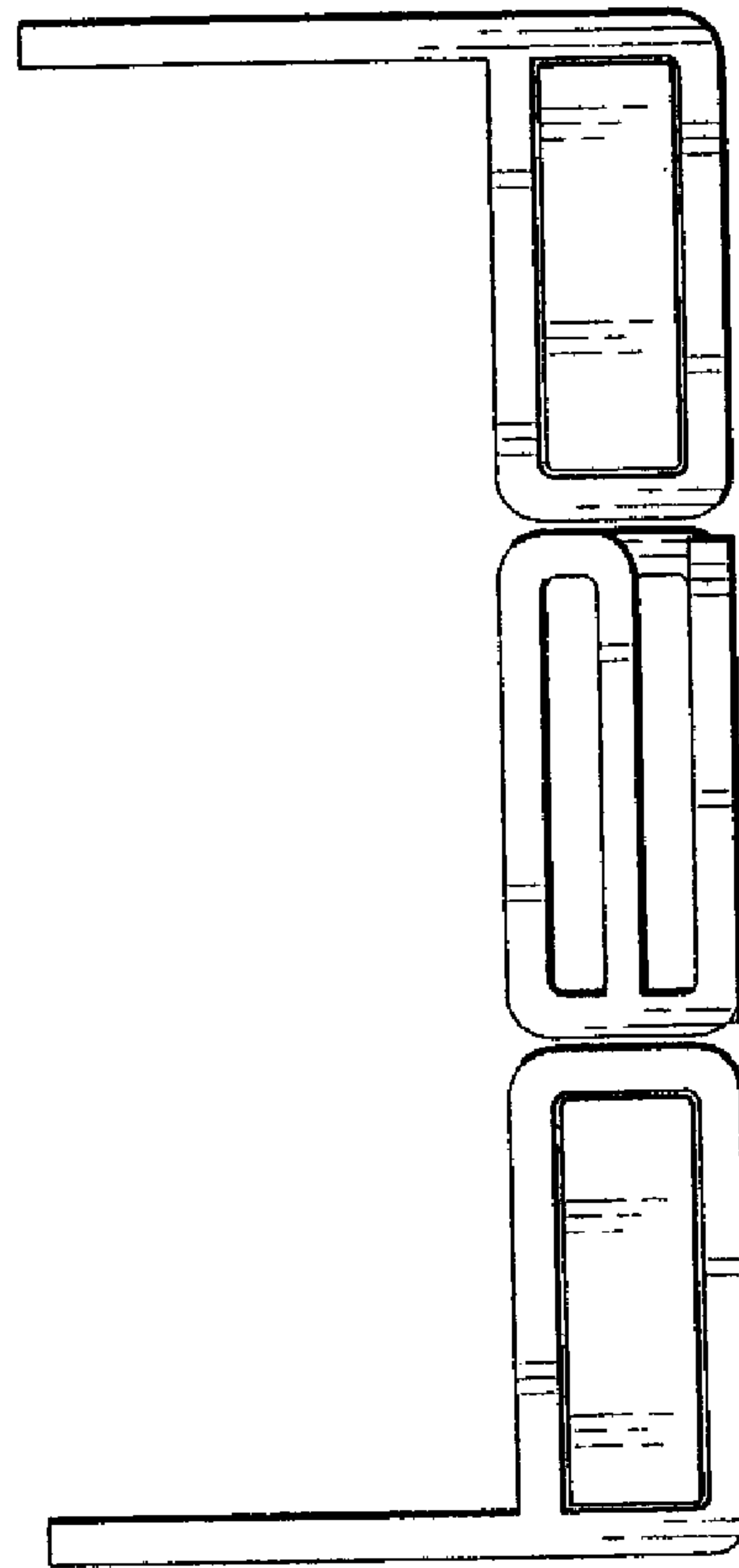

FIGURE 7

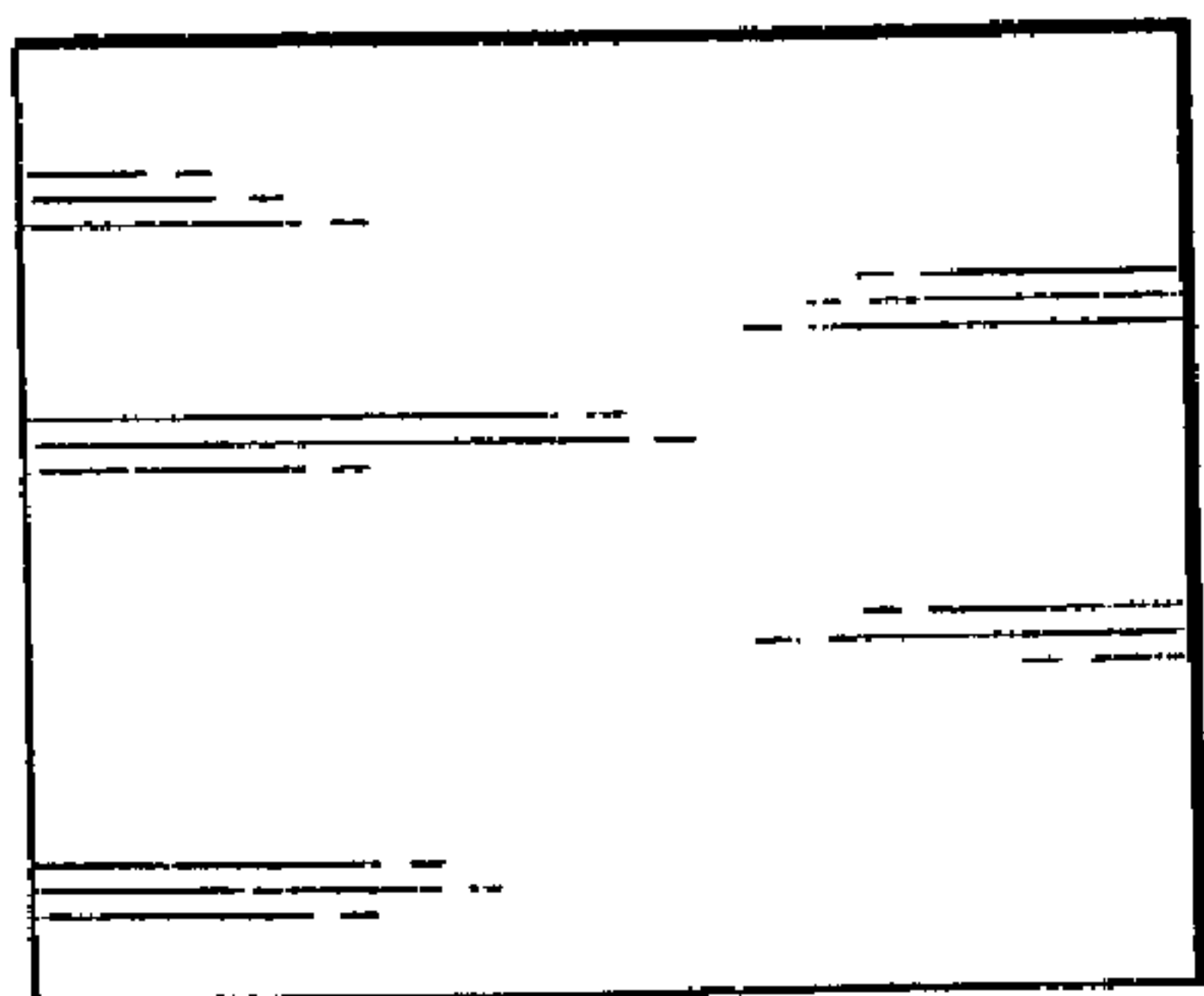

FIGURE 4