



US00D560896S

(12) **United States Design Patent**
Belley et al.

(10) **Patent No.:** **US D560,896 S**

(45) **Date of Patent:** **** Feb. 5, 2008**

(54) **FOOTWEAR UPPER**

D548,941 S * 8/2007 Hulbert D2/969

(75) Inventors: **Manon Belley**, Laval (CA); **Julie St. Louis**, Montreal (CA); **Martin W. F. Dean**, St. Albans (GB)

OTHER PUBLICATIONS

CAT Footwear 1997 Catalog, p. 32.
Hush Puppies Kids 1997 Catalog, p. 4.

(73) Assignee: **Wolverine World Wide, Inc.**,
Rockford, MI (US)

* cited by examiner

(**) Term: **14 Years**

Primary Examiner—Dominic Simone

(21) Appl. No.: **29/268,637**

(74) *Attorney, Agent, or Firm*—Warner Norcross & Judd
LLP

(22) Filed: **Nov. 9, 2006**

(57) **CLAIM**

(51) **LOC (8) Cl.** **02-99**

The ornamental design for footwear upper, as shown and described.

(52) **U.S. Cl.** **D2/969**

DESCRIPTION

(58) **Field of Classification Search** D2/896,
D2/900, 902, 903, 905, 907, 908, 916, 919–921,
D2/923–925, 943, 944, 969, 972–974, 977;
36/8.1, 9 R, 10, 45, 50.1, 77 M, 77 R, 78,
36/83, 88, 112–114, 126–131

FIG. 1 is a perspective view of the footwear upper embodying the new design;

FIG. 2 is a top view thereof;

FIG. 3 is a right side view thereof;

FIG. 4 is a left side view thereof;

FIG. 5 is a front view thereof; and,

FIG. 6 is a rear view thereof.

See application file for complete search history.

FIGS. 1–6 show features of an article of footwear in phantom lines. These features are shown for environmental purposes and do not form any part of the claimed design. Further, the phantom lines immediately adjacent the solid-line portions of the design form the boundary of the design, with the phantom lines forming no part of the claimed design.

(56) **References Cited**

U.S. PATENT DOCUMENTS

- D229,989 S * 1/1974 Sedley D2/907
- D237,425 S * 11/1975 Askew D2/907
- D237,427 S * 11/1975 Robinson D2/907
- D500,406 S 1/2005 Belley et al.
- D517,298 S * 3/2006 James D2/969
- D517,299 S * 3/2006 Drury D2/969
- D532,191 S 11/2006 Belley et al.
- D543,017 S * 5/2007 Hulbert D2/969
- D544,187 S * 6/2007 Hulbert D2/969
- D548,940 S * 8/2007 Hulbert D2/969

1 Claim, 4 Drawing Sheets

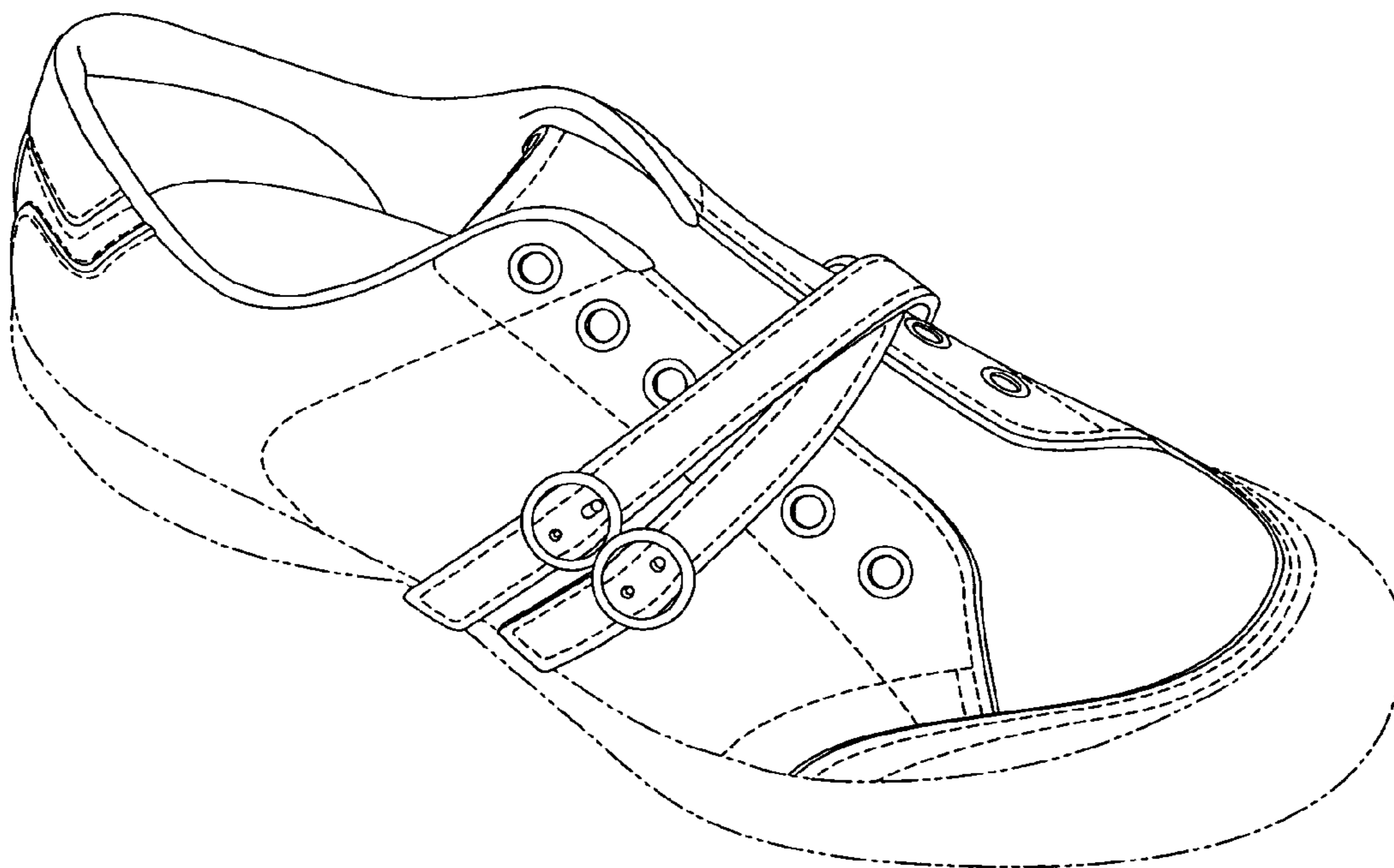

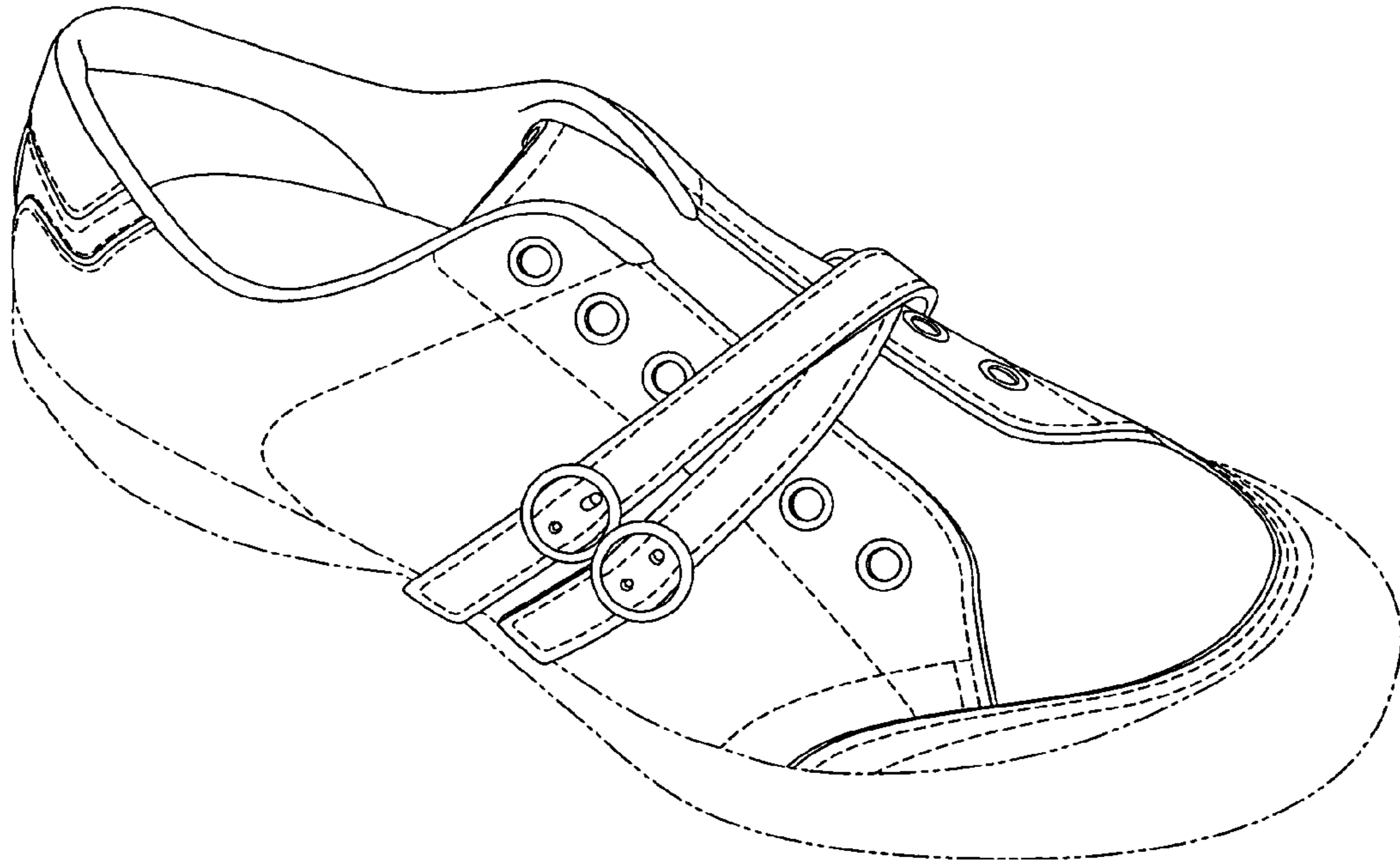

Fig. 1

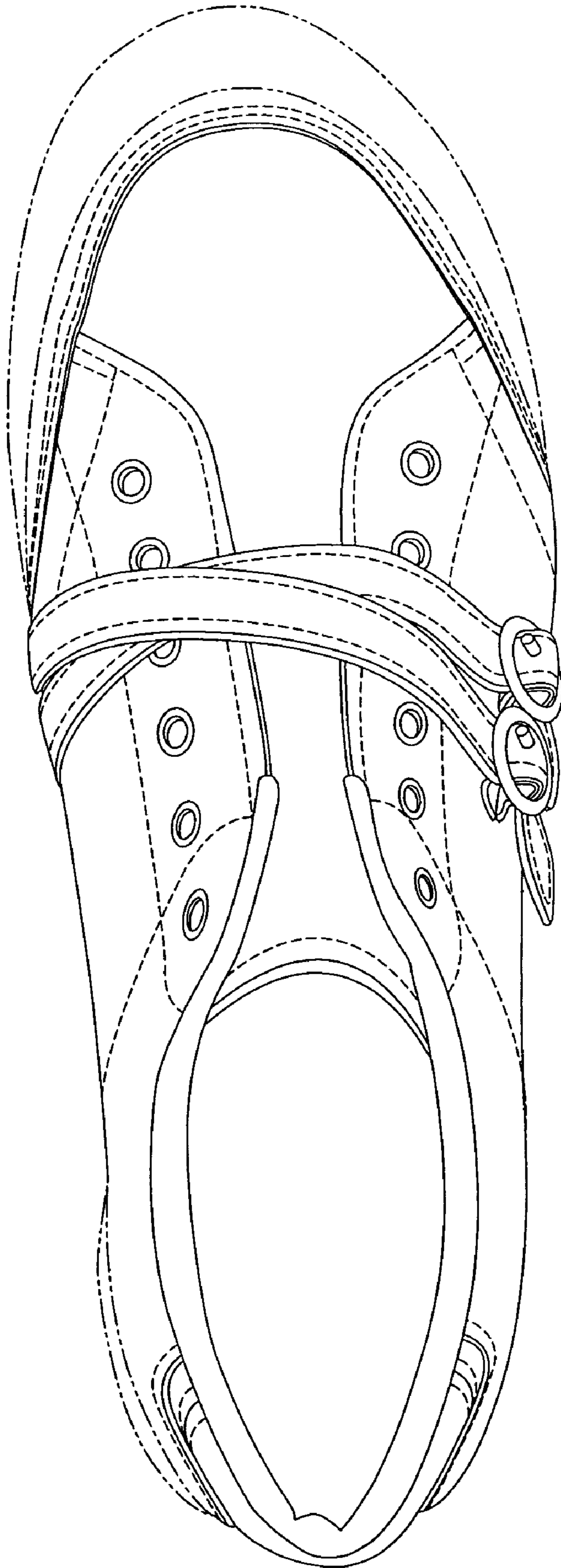

Fig.2

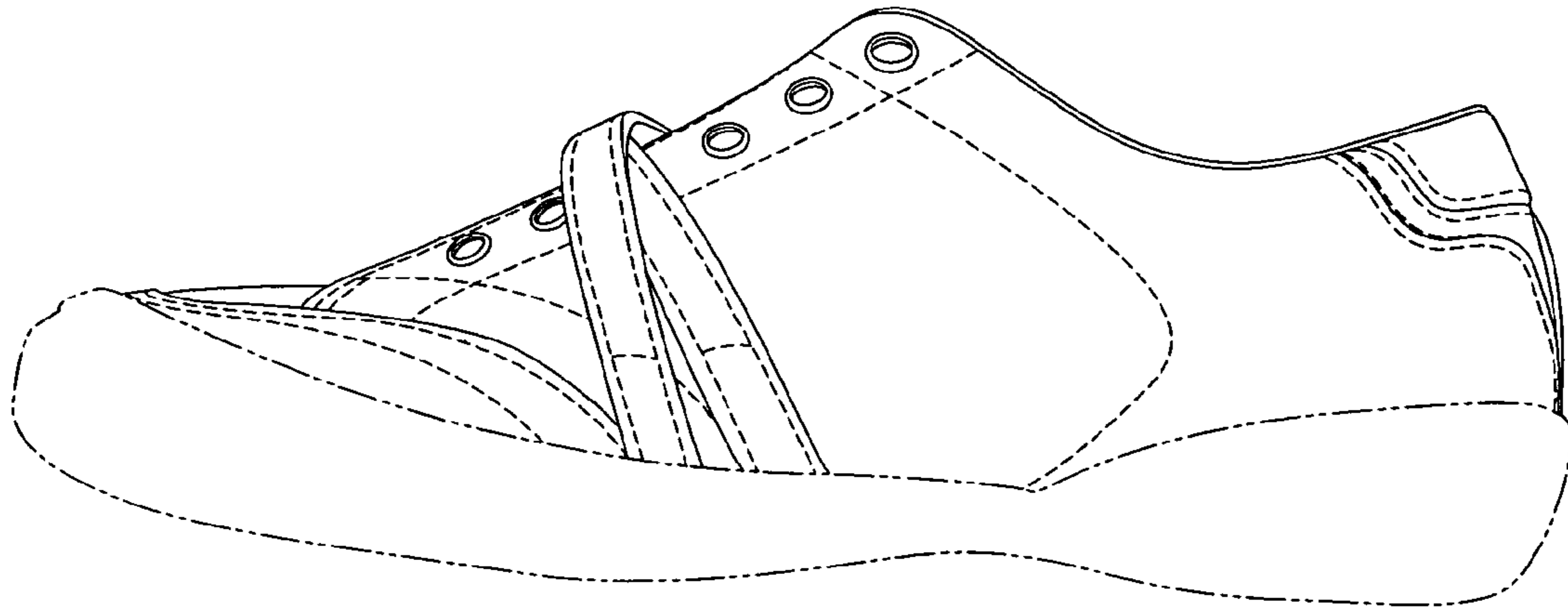

Fig.3

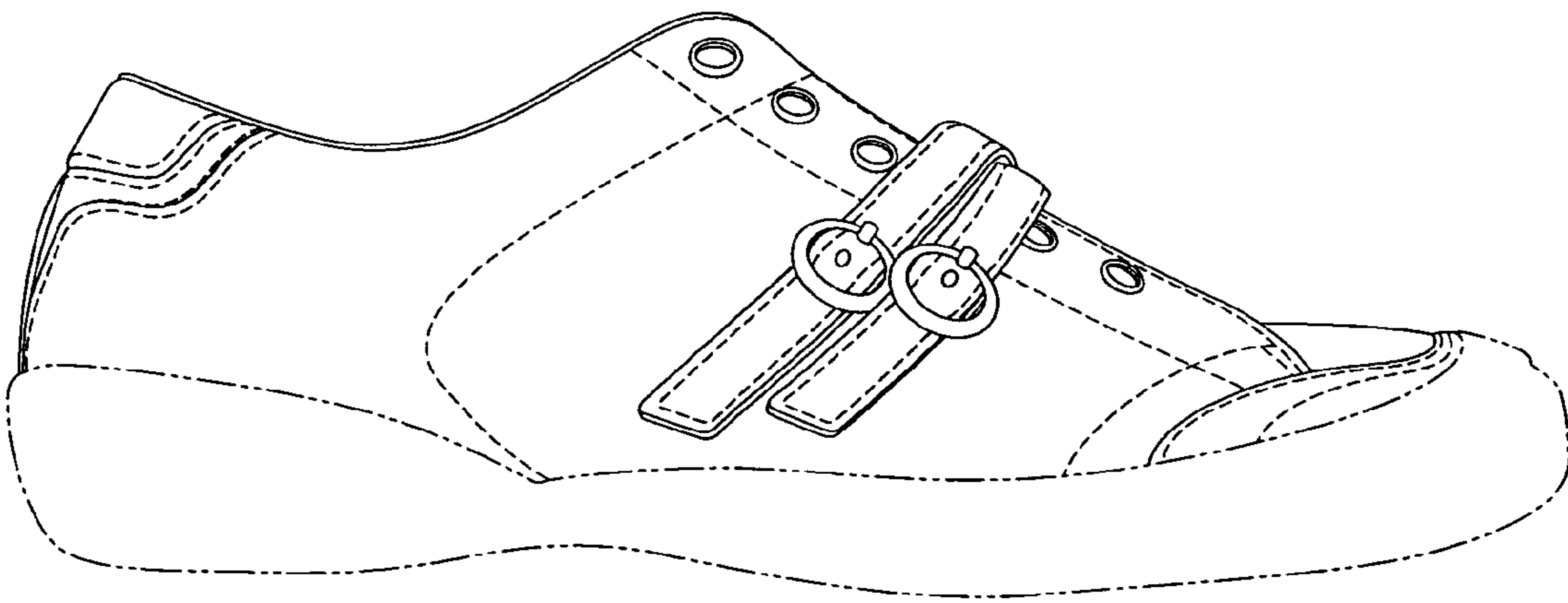

Fig.4

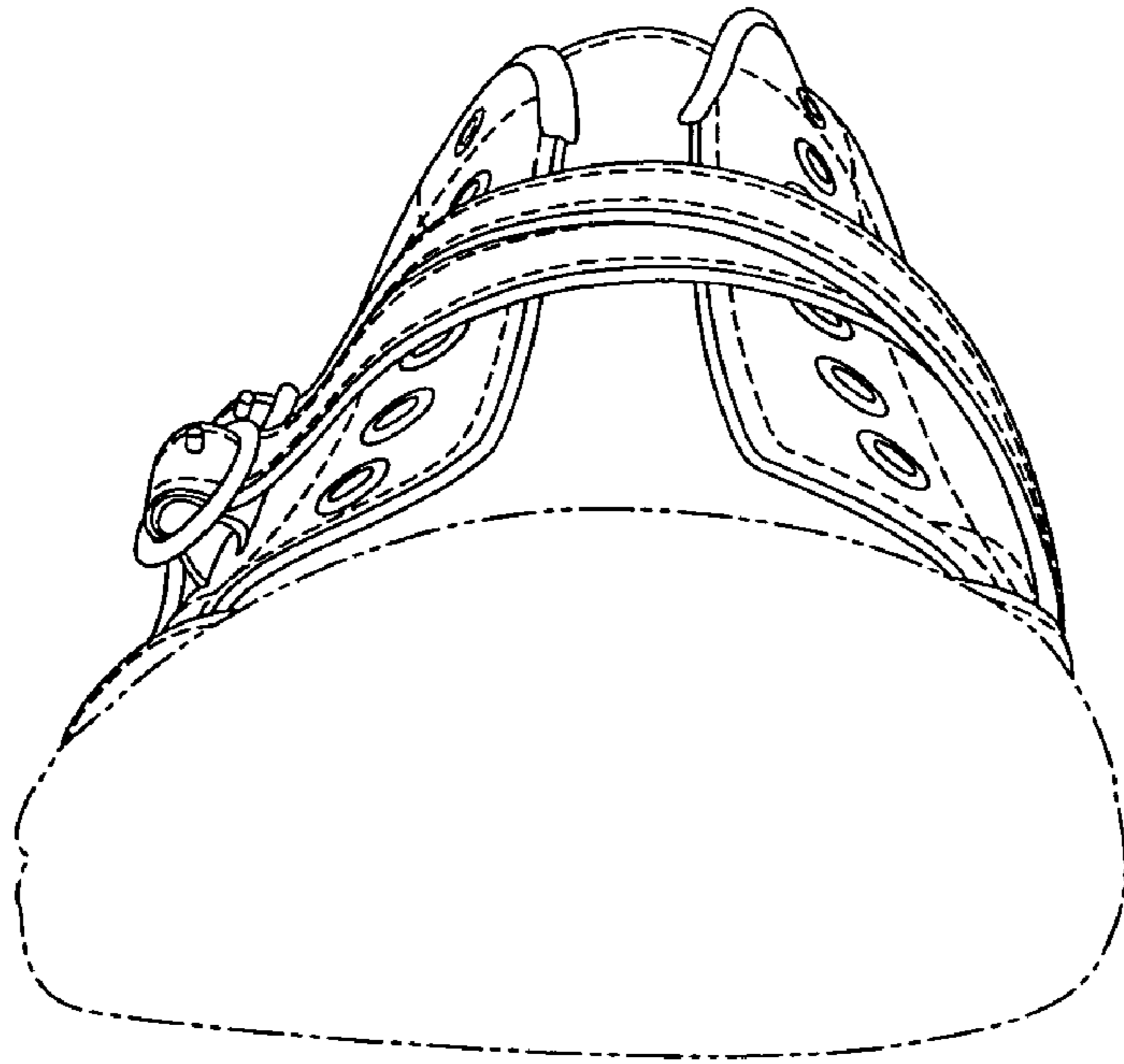

Fig.5

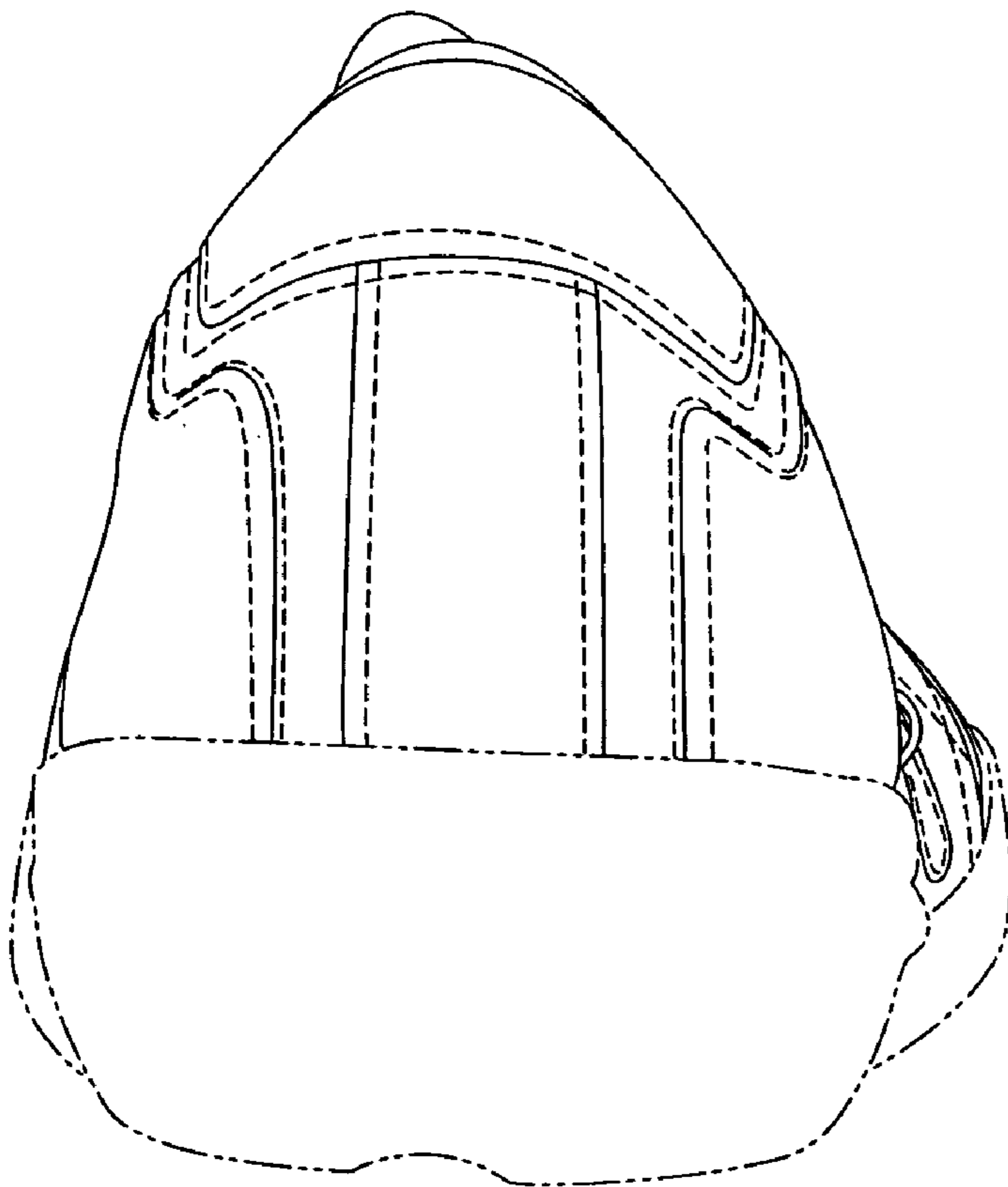

Fig.6