



US00D560778S

(12) **United States Design Patent**
Paterson

(10) **Patent No.:** **US D560,778 S**

(45) **Date of Patent:** **** Jan. 29, 2008**

(54) **LAVATORY**

(75) Inventor: **Nicholas W. Paterson**, Sheyboygan Falls, WI (US)

(73) Assignee: **Kohler Co.**, Kohler, WI (US)

(**) Term: **14 Years**

(21) Appl. No.: **29/275,078**

(22) Filed: **Dec. 12, 2006**

(51) **LOC (8) Cl.** **23-02**

(52) **U.S. Cl.** **D23/293.1**

(58) **Field of Classification Search** D23/271–274, D23/284–293.1, 303, 308; 4/619, 624, 661
See application file for complete search history.

(56) **References Cited**

U.S. PATENT DOCUMENTS

D411,288 S 6/1999 Cuttriss
6,353,944 B1 * 3/2002 Clayton 4/651
D506,814 S * 6/2005 Alger D23/293.1

OTHER PUBLICATIONS

Decolav. "Round Vitreous China Vessel with Overflow". Model No.: 1410-CWH. Decolav.com online catalog. Copyright 2006 Decolav Inc.

Whitehaus. Stonehaus Collection—"Eilat", Model No. WHO500 and "Haifa", Model No.: Wh1000. Decolav.com online catalog. Copyright 2006 Decolav Inc.

Kohler Co. "Kamala Vessels Lavatory", Model No.: K-14281-TF. Kohler Co. online catalog. Copyright 2007 Kohler Co.

* cited by examiner

Primary Examiner—Robert A. Delehanty

(74) *Attorney, Agent, or Firm*—Quarles & Brady LLP

(57) **CLAIM**

The ornamental design for a lavatory, as shown and described.

DESCRIPTION

In a preferred embodiment, the nature of this product is as a plumbing fixture in the form of a lavatory which is primarily useful for washing the body parts of humans.

FIG. 1 is a top, left, front perspective view of a lavatory embodying my new design;

FIG. 2 is a top plan view thereof;

FIG. 3 is a front elevational view thereof, the rear elevational view thereof being a mirror image of the front view shown;

FIG. 4 is a left side elevational view thereof, the right side elevational view thereof being a mirror image of the left side shown;

FIG. 5 is a bottom plan view thereof;

FIG. 6 is a sectional view thereof taken along line 6—6 of FIG. 2; and,

FIG. 7 is a sectional view thereof taken along line 7—7 of FIG. 2.

The broken line representations of a drain in the figures are for the purpose of illustration only, and form no part of the claimed design.

1 Claim, 4 Drawing Sheets

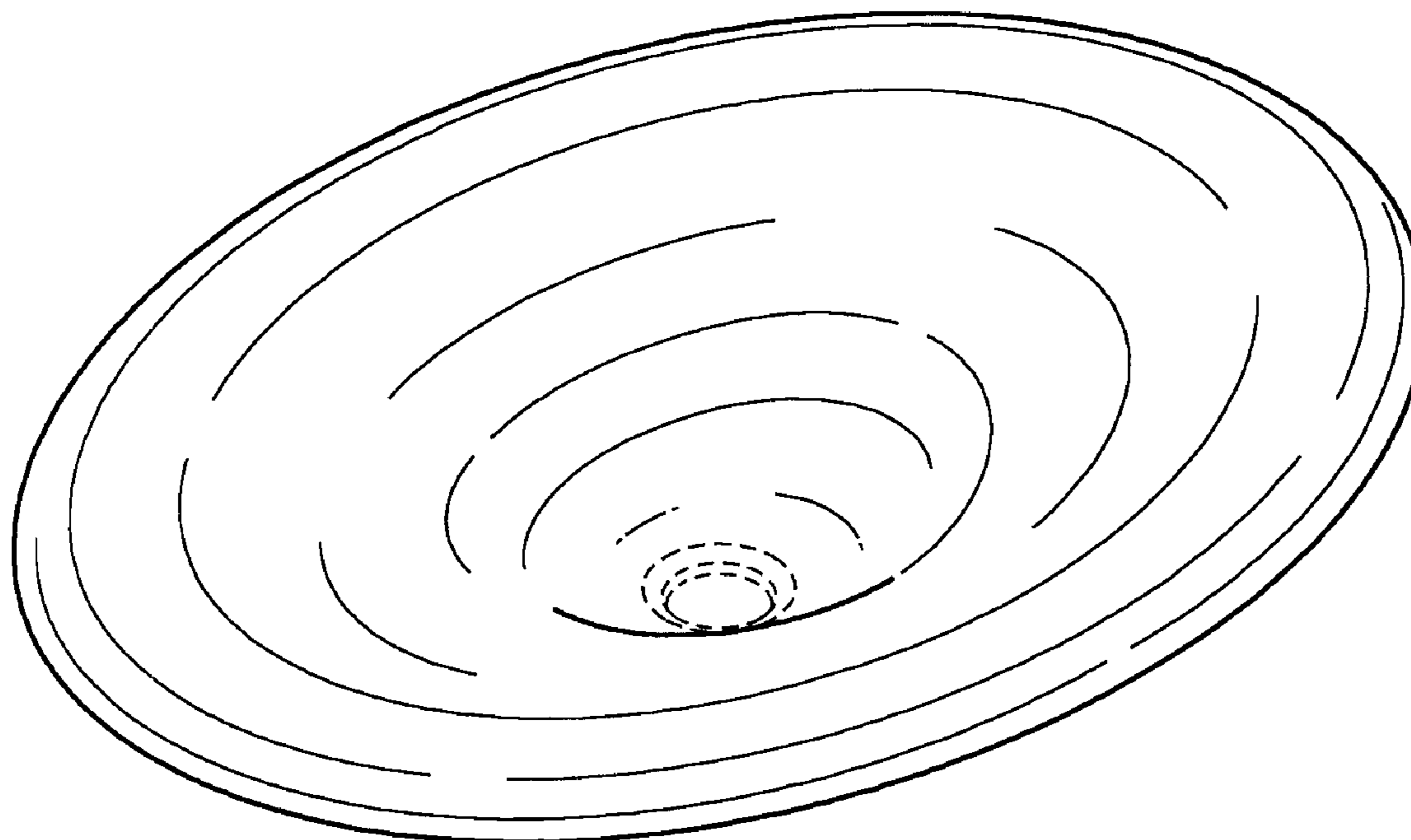

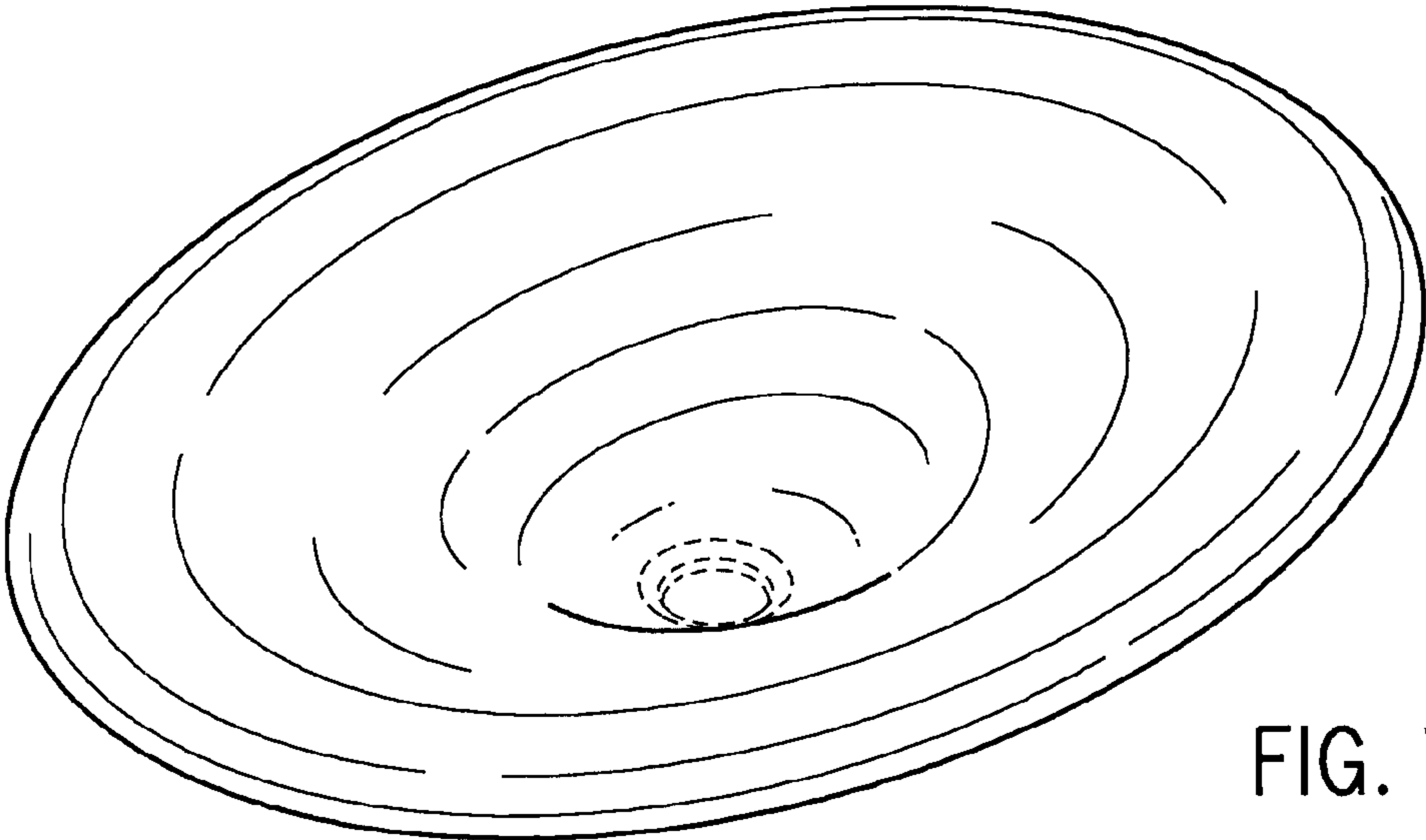

FIG. 1

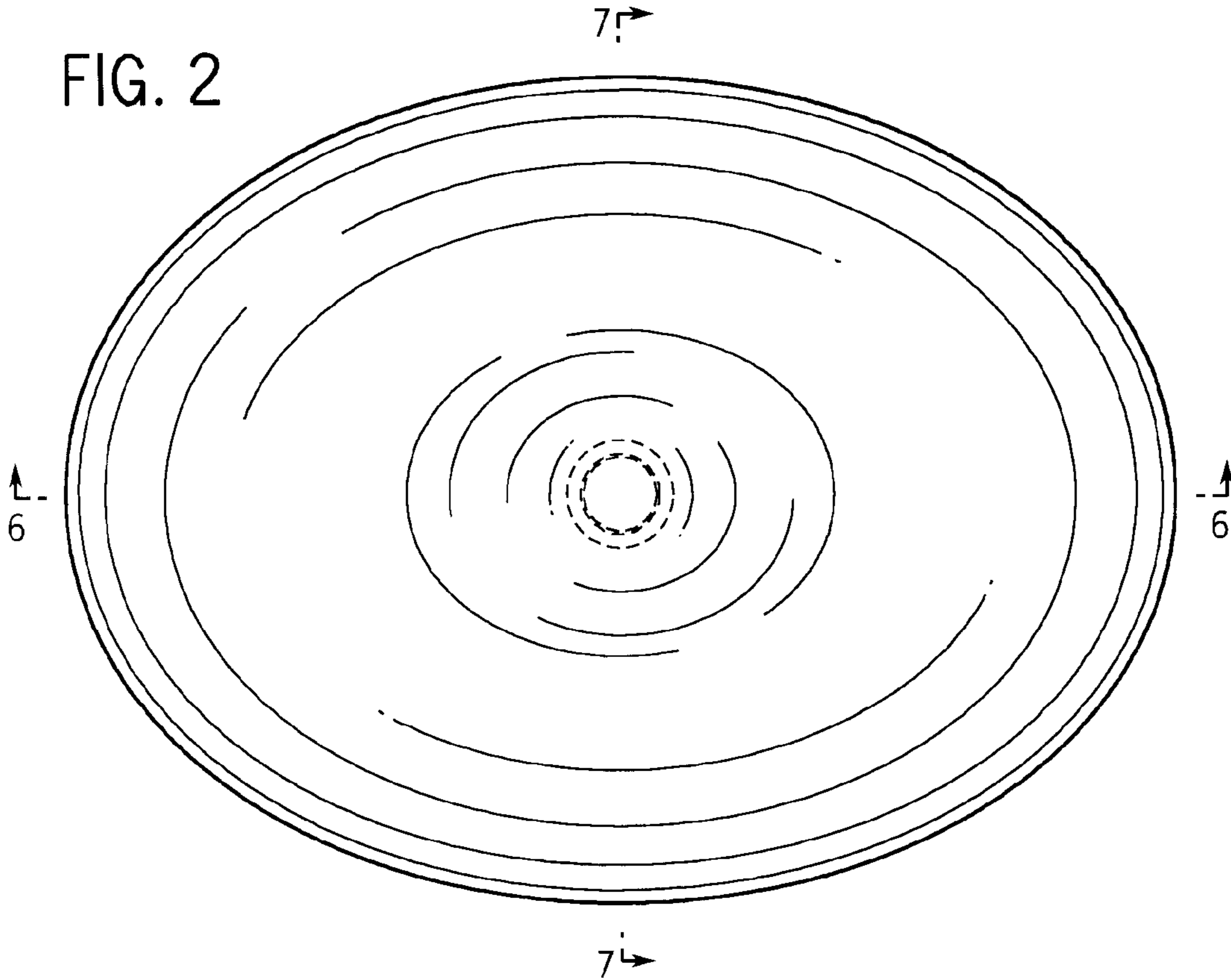

FIG. 2

FIG. 3

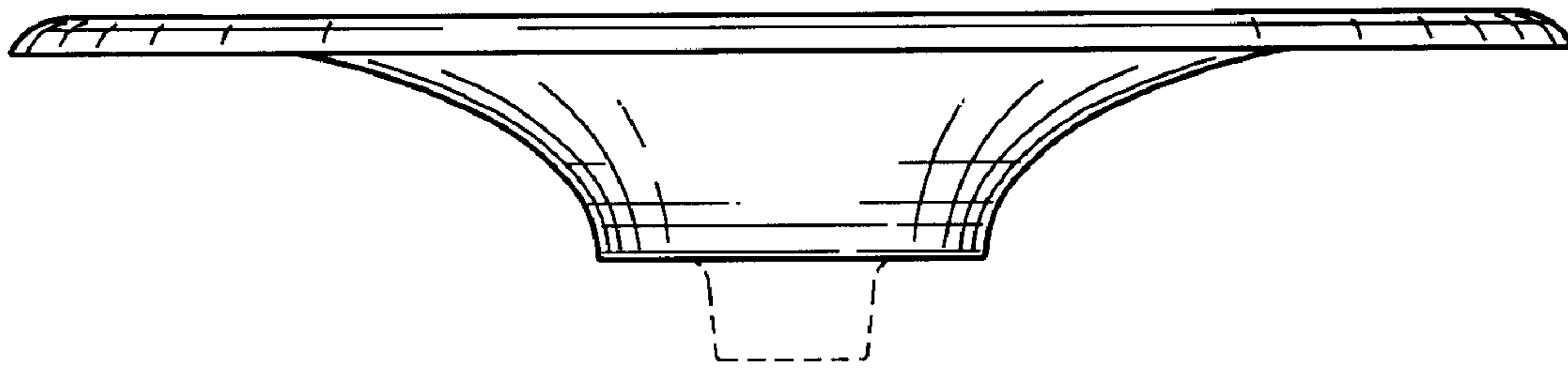
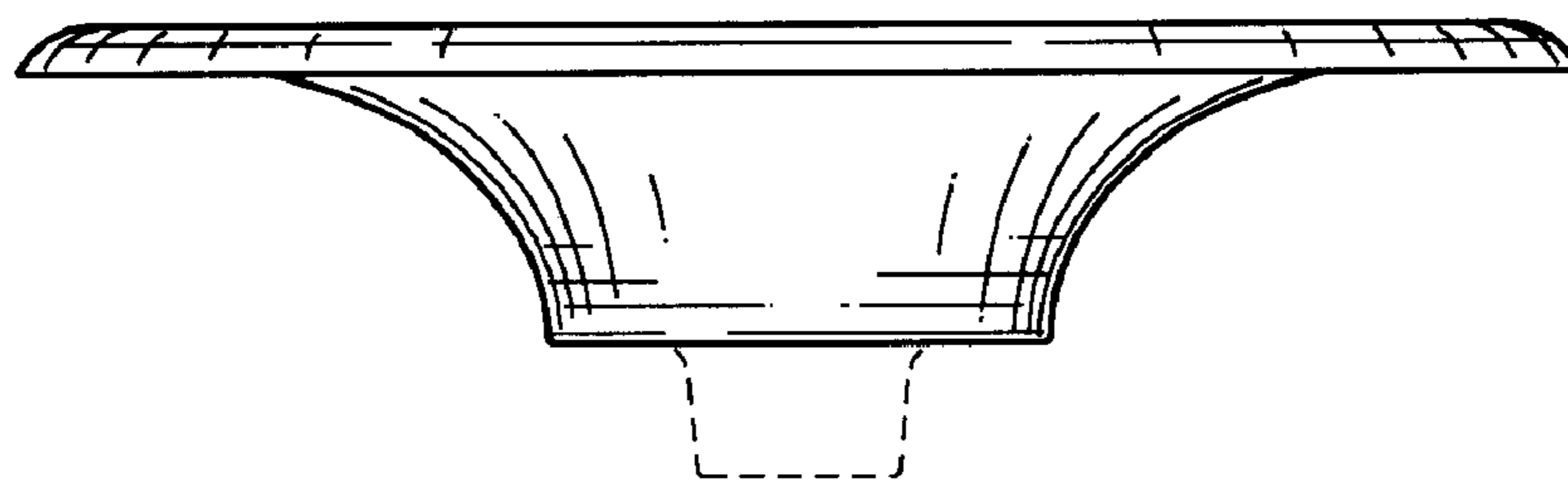

FIG. 4



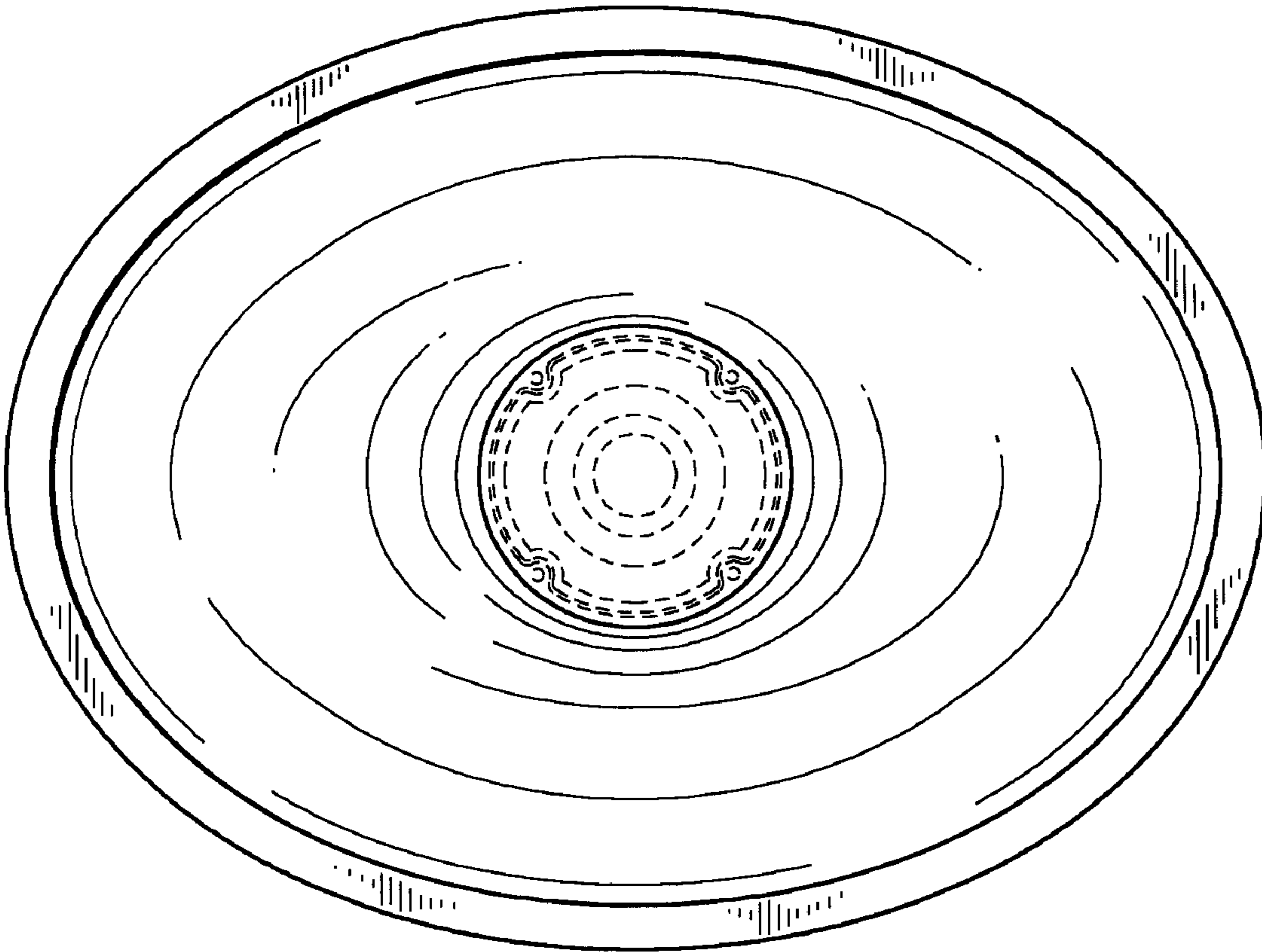

FIG. 5

FIG. 6

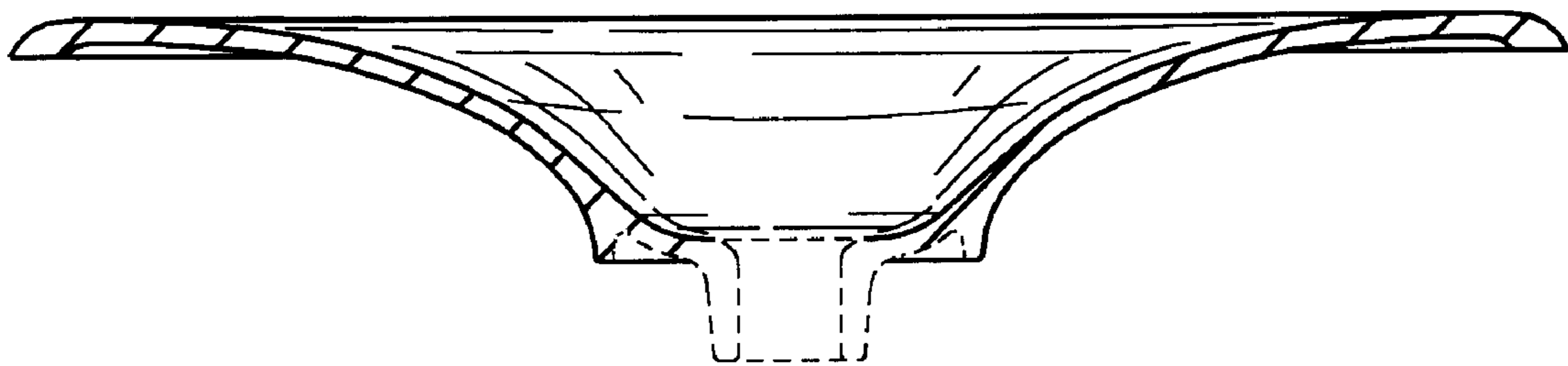

FIG. 7

