

US00D560775S

(12) **United States Design Patent**
Hanna

(10) **Patent No.:** **US D560,775 S**

(45) **Date of Patent:** **** Jan. 29, 2008**

(54) **LAVATORY**

(75) Inventor: **Ken S. Hanna**, Adell, WI (US)

(73) Assignee: **Kohler Co.**, Kohler, WI (US)

(**) Term: **14 Years**

(21) Appl. No.: **29/250,198**

(22) Filed: **Nov. 6, 2006**

(51) **LOC (8) Cl.** **23-02**

(52) **U.S. Cl.** **D23/293.1**

(58) **Field of Classification Search** D23/271–274,
D23/284–293.1, 303, 308; 4/619, 624, 661
See application file for complete search history.

(56) **References Cited**

U.S. PATENT DOCUMENTS

- D400,237 S 10/1998 Millard et al.
- 6,353,944 B1 * 3/2002 Clayton 4/651
- D506,814 S * 6/2005 Alger D23/293.1

OTHER PUBLICATIONS

- An undated Regis advertisement for glass lavatories.
- A 2004 Kohler advertisement for “New Products”.
- A 2006 Kohler advertisement for the Devonshire lavatory.

* cited by examiner

Primary Examiner—Robert A. Delehanty

(74) *Attorney, Agent, or Firm*—Quarles & Brady LLP

(57) **CLAIM**

The ornamental design for a lavatory, as shown and described.

DESCRIPTION

In a preferred embodiment, the nature of this product is as a lavatory suitable for washing hands or the face.

FIG. 1 is a left, top, front perspective view of a lavatory according to my new design;

FIG. 2 is a top plan view thereof;

FIG. 3 is a front elevational view thereof;

FIG. 4 is a right side elevational view thereof, the left side elevational view being a mirror image of the right side shown;

FIG. 5 is a rear elevational view thereof;

FIG. 6 is a bottom plan view thereof;

FIG. 7 is a sectional view taken along line 7—7 of FIG. 2; and,

FIG. 8 is a sectional view taken along line 8—8 of FIG. 2.

1 Claim, 4 Drawing Sheets

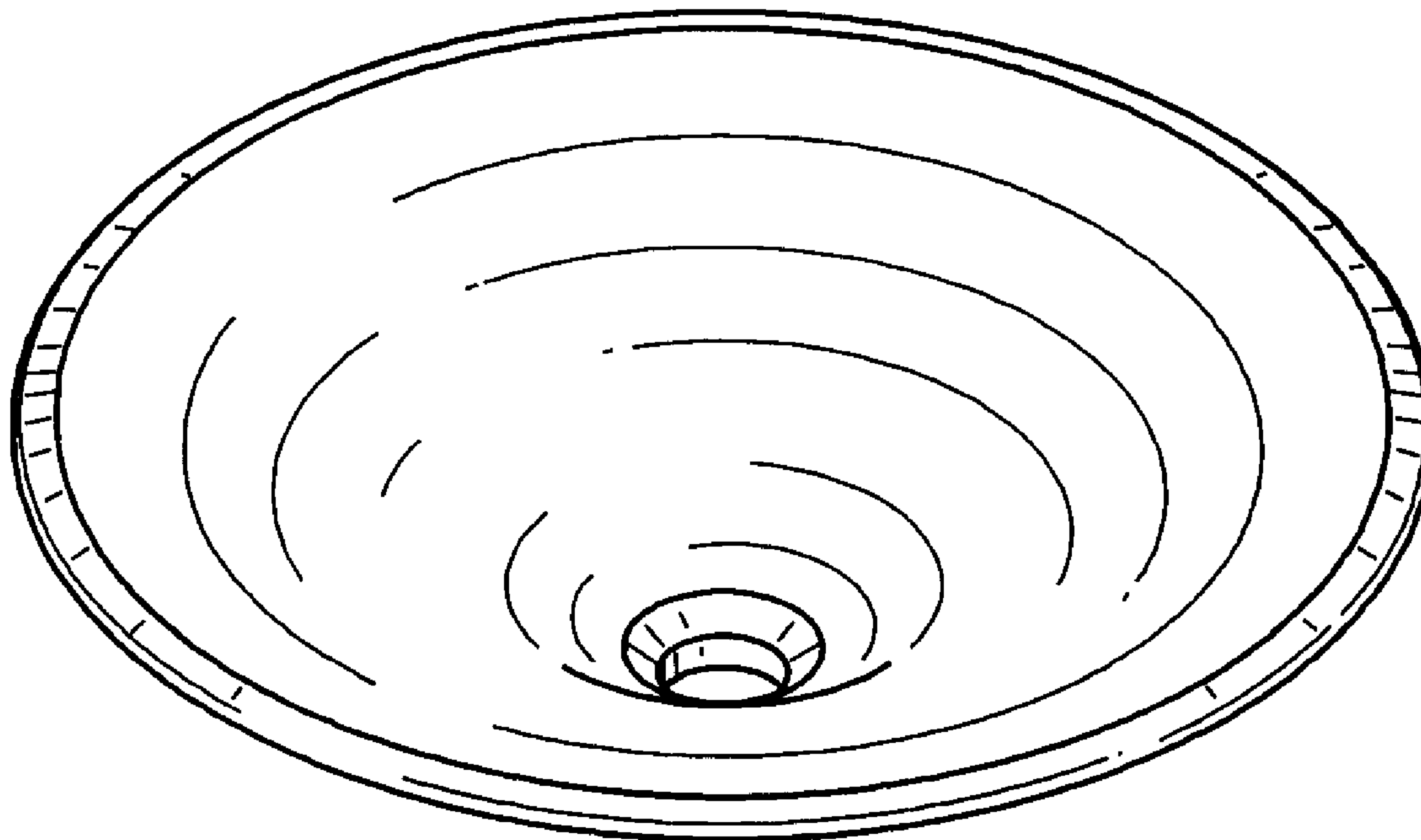

FIG. 1

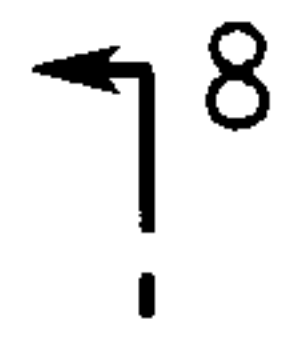
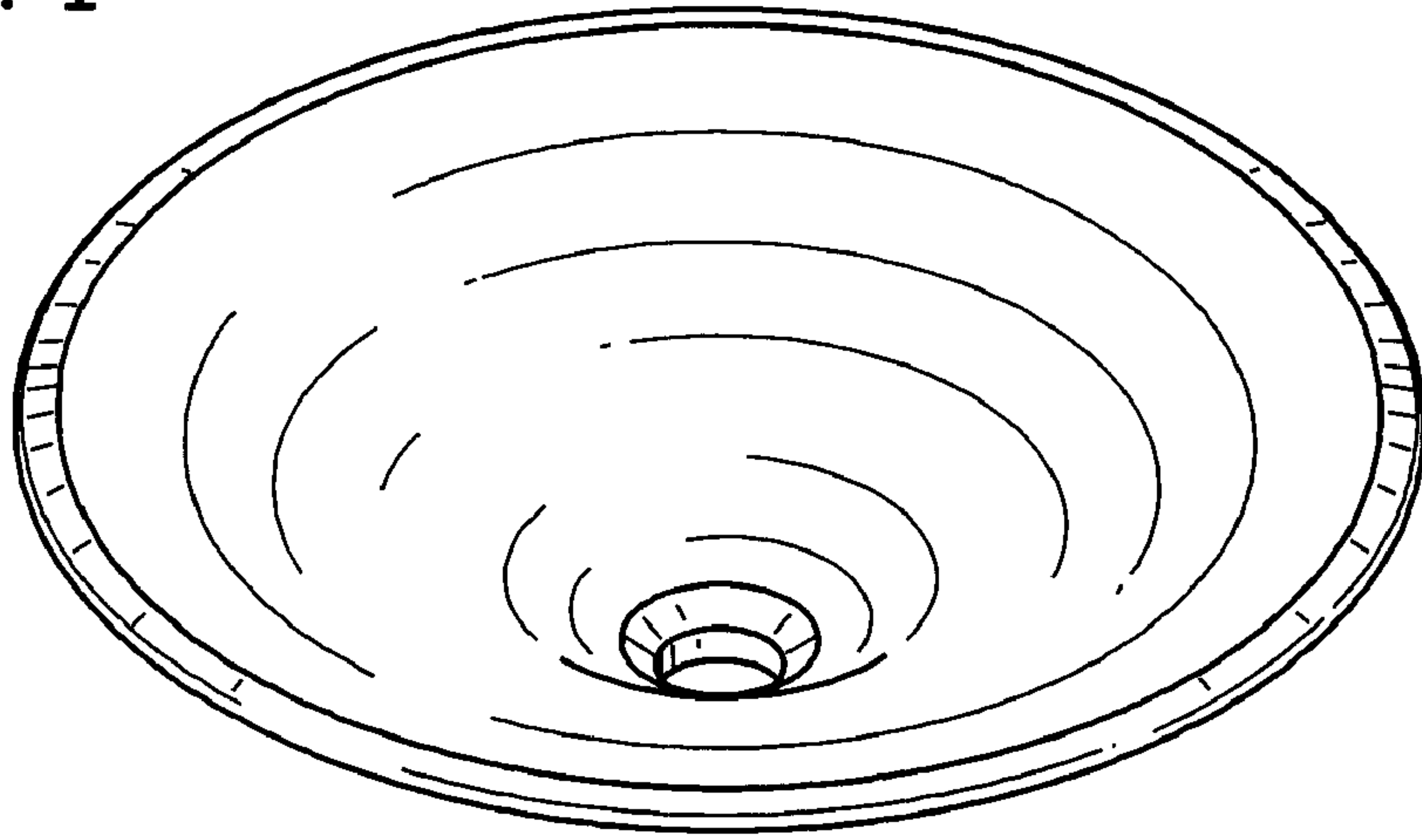

FIG. 2

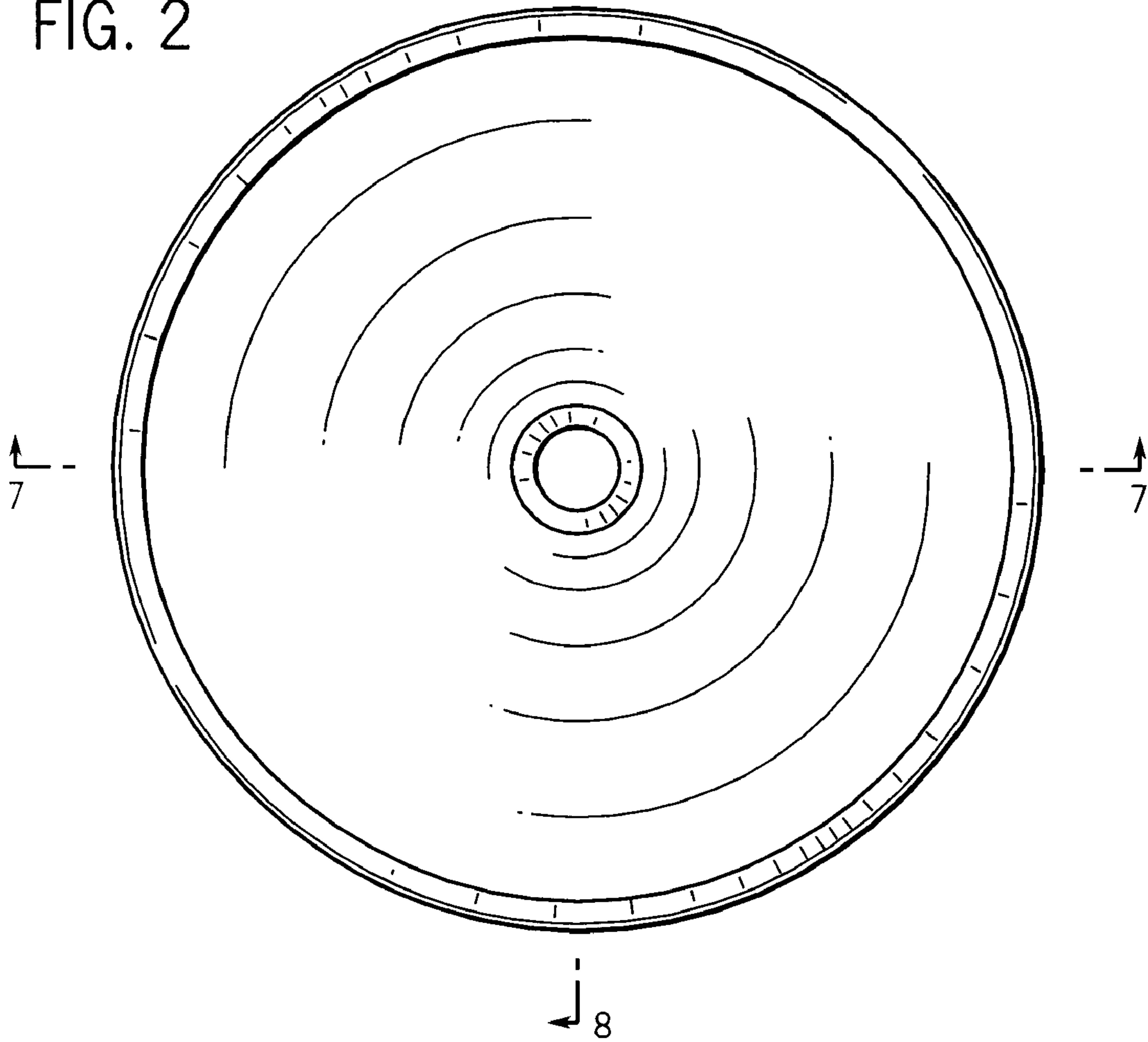

FIG. 3

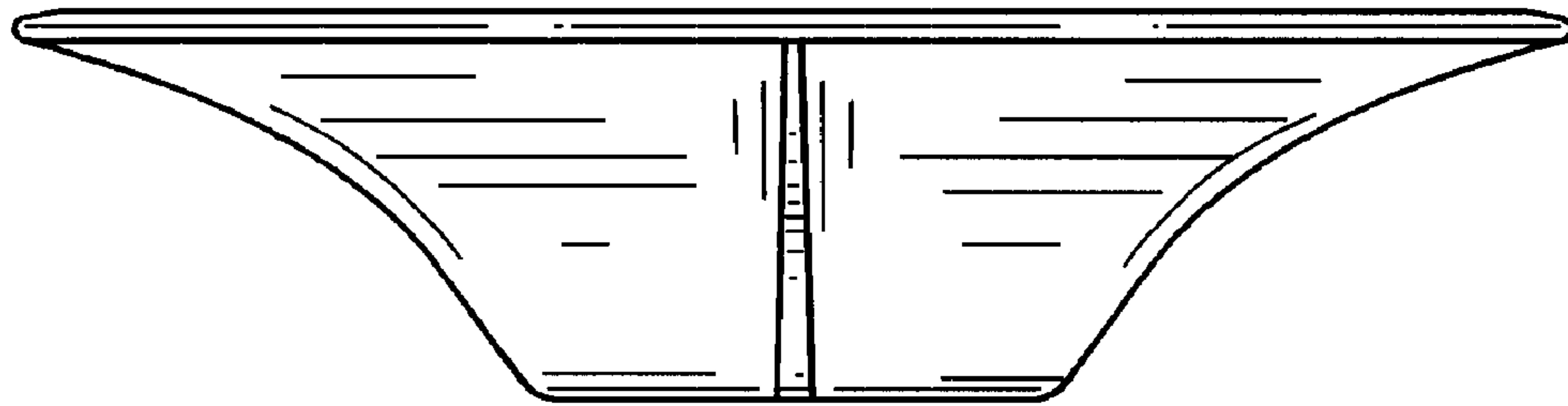

FIG. 4

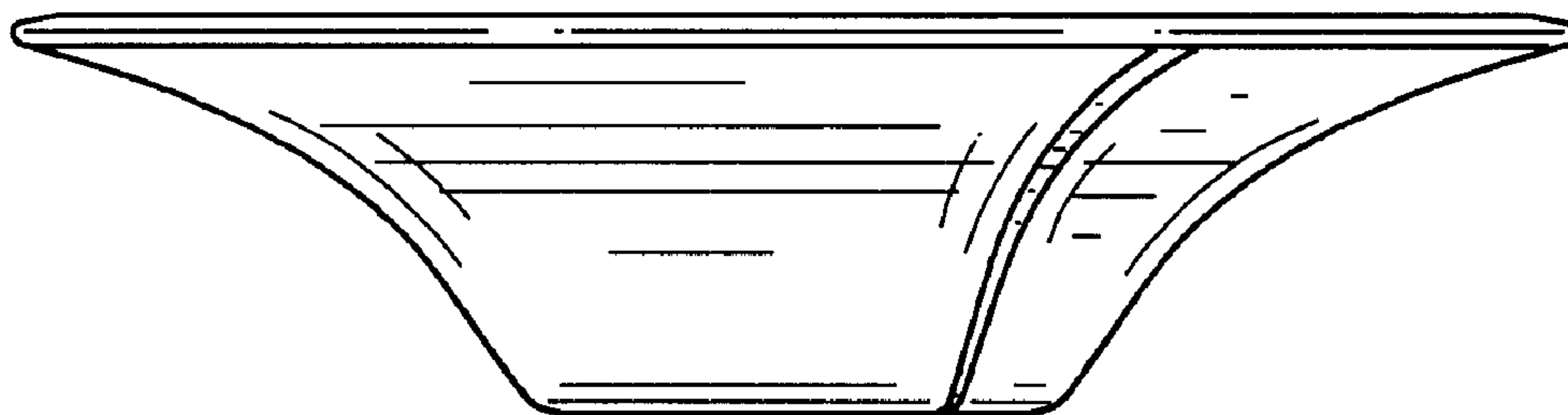
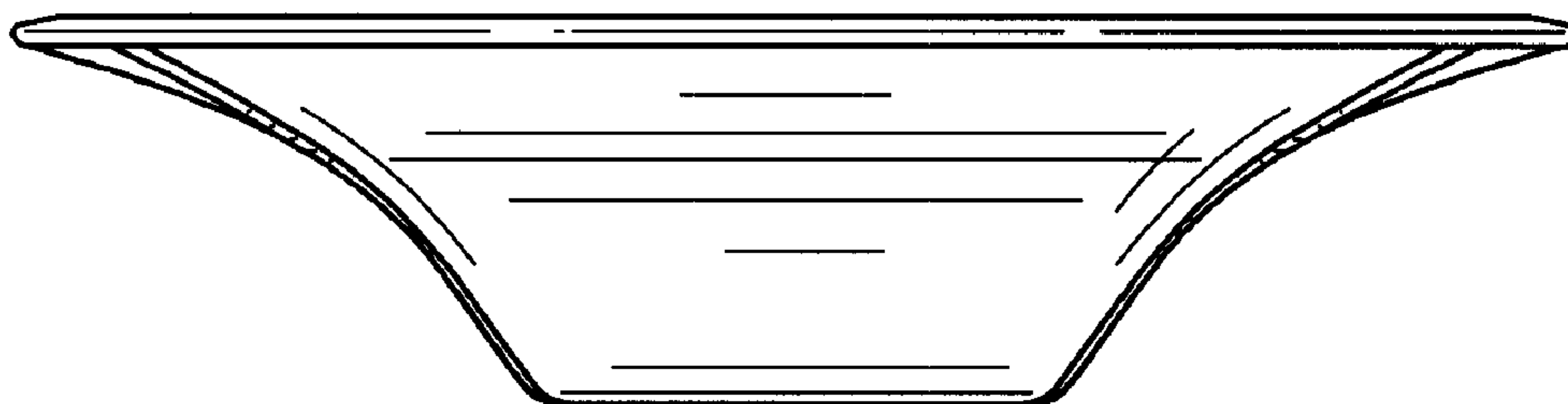

FIG. 5



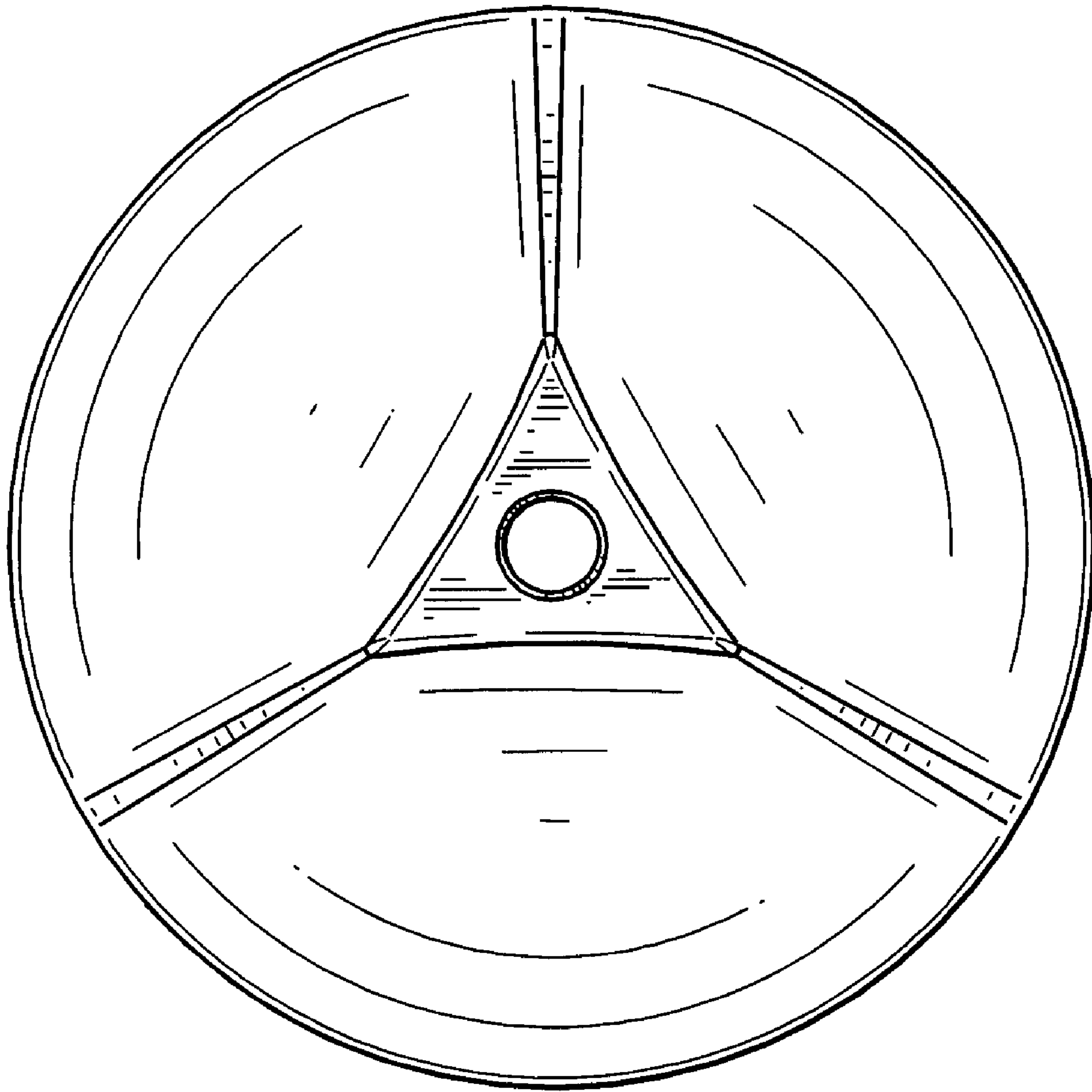

FIG. 6

FIG. 7

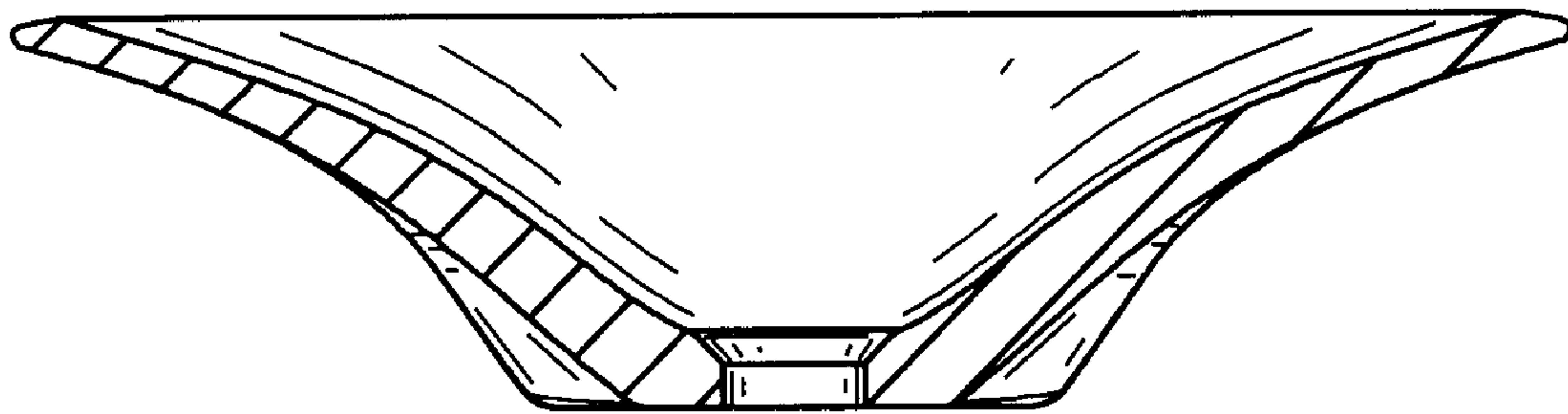

FIG. 8

