

US00D560722S

(12) **United States Design Patent**
Huang

(10) **Patent No.:** **US D560,722 S**
(45) **Date of Patent:** **** Jan. 29, 2008**

(54) **PEN STAND**

(76) Inventor: **Te-Ming Huang**, 5F-11, No.16, Lane
609, Sec. 5, Chung-Hsin Road, San
Chung City, Taipei Hsien (TW)

(**) Term: **14 Years**

(21) Appl. No.: **29/246,696**

(22) Filed: **May 4, 2006**

(51) **LOC (8) Cl.** **19-06**

(52) **U.S. Cl.** **D19/85**

(58) **Field of Classification Search** D19/35,
D19/36, 54, 75-92; 24/10 R, 11 CT; 206/214,
206/575; 211/69.1-69.9; 248/127, 146,
248/314; 401/131

See application file for complete search history.

(56) **References Cited**

U.S. PATENT DOCUMENTS

D156,091 S *	11/1949	Gardiner	D9/522
2,497,418 A *	2/1950	Schroeder, Jr.	401/48
2,650,570 A *	9/1953	Voelcker	211/69.5
D239,443 S *	4/1976	Connoy	D19/54
4,548,325 A *	10/1985	Hojer et al.	211/69.5
D421,462 S *	3/2000	Orchanian	D19/77
D428,924 S *	8/2000	Brouwer et al.	D19/85
D428,925 S *	8/2000	Brouwer et al.	D19/85
D436,998 S *	1/2001	Brouwer et al.	D19/84
D451,962 S *	12/2001	Thornton	D19/78
D452,883 S *	1/2002	DeLuca et al.	D19/84
D470,532 S *	2/2003	Joss et al.	D19/85

D492,357 S *	6/2004	Tien	D19/83
D500,797 S *	1/2005	Dunlap	D19/73
D525,306 S *	7/2006	Hirota	D19/84

* cited by examiner

Primary Examiner—Elizabeth A. Albert

(57) **CLAIM**

The ornamental design for pen stand, as shown and described.

DESCRIPTION

FIG. 1 is a perspective view of pen stand showing my new design;

FIG. 2 is a front elevational view thereof;

FIG. 3 is a rear elevational view thereof;

FIG. 4 is a left elevational view thereof;

FIG. 5 is a right elevational view thereof;

FIG. 6 is a top view thereof; and

FIG. 7 is a bottom view thereof; and,

FIG. 8 is a front elevational view of the two parts of the pen stand separated.

The broken lines showing features inside the top openings in FIGS. 1, 5 and 6 and a portion of one side of the pen stand in FIG. 4 as well as the objects shown between the separated parts of the pen stand in FIG. 8 are included for the purpose of illustrating environment and form no part of the claimed design.

1 Claim, 8 Drawing Sheets

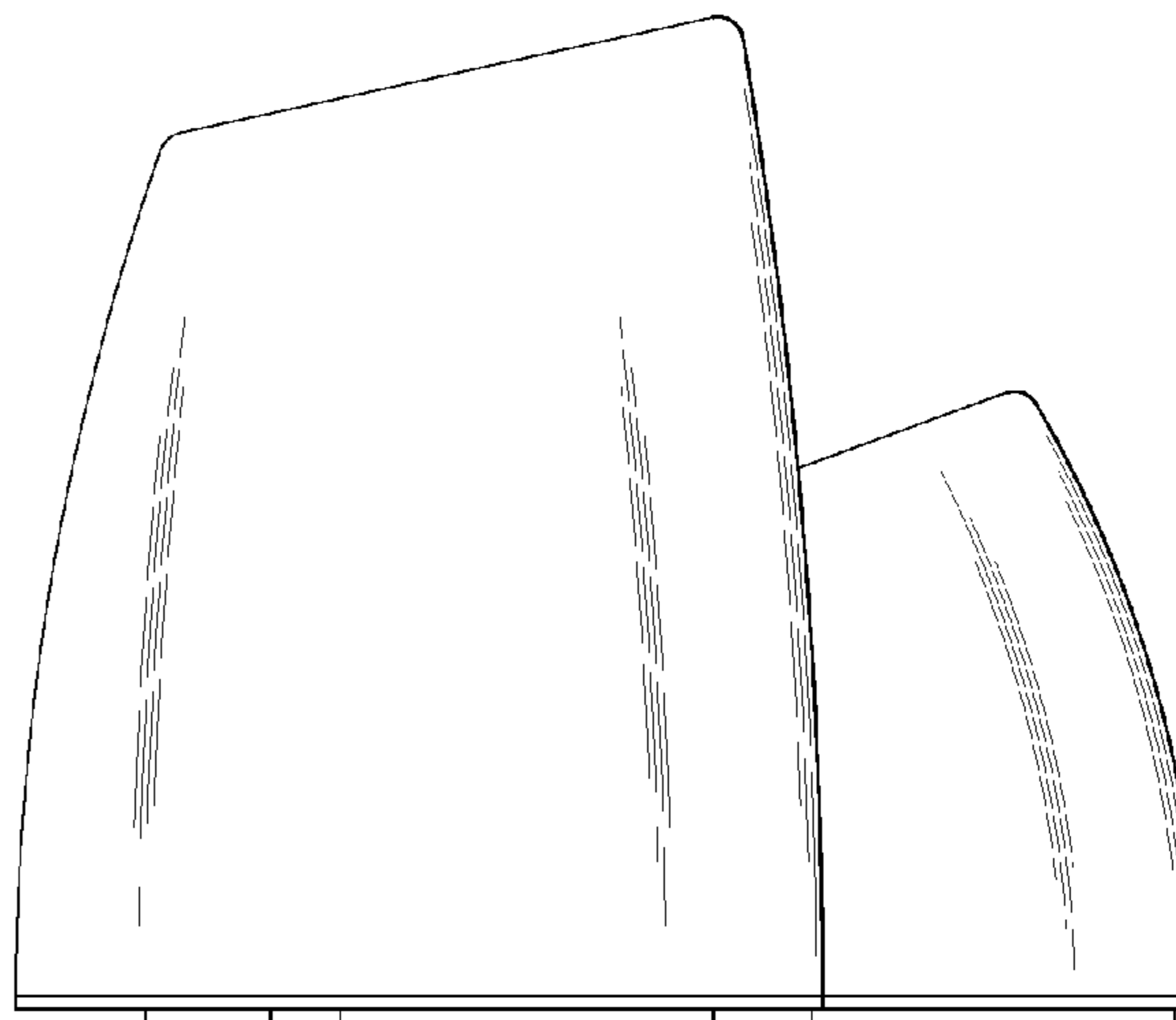
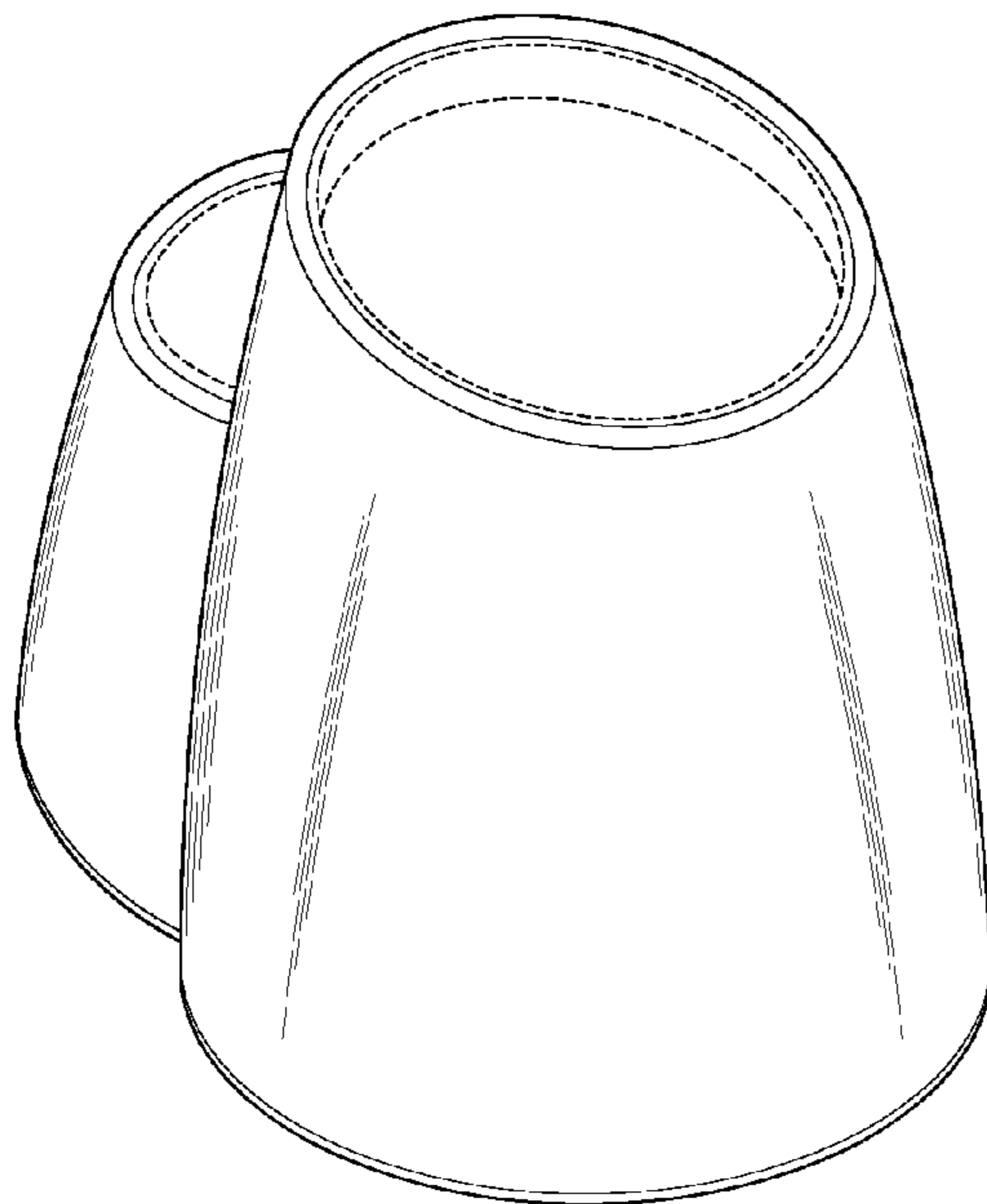

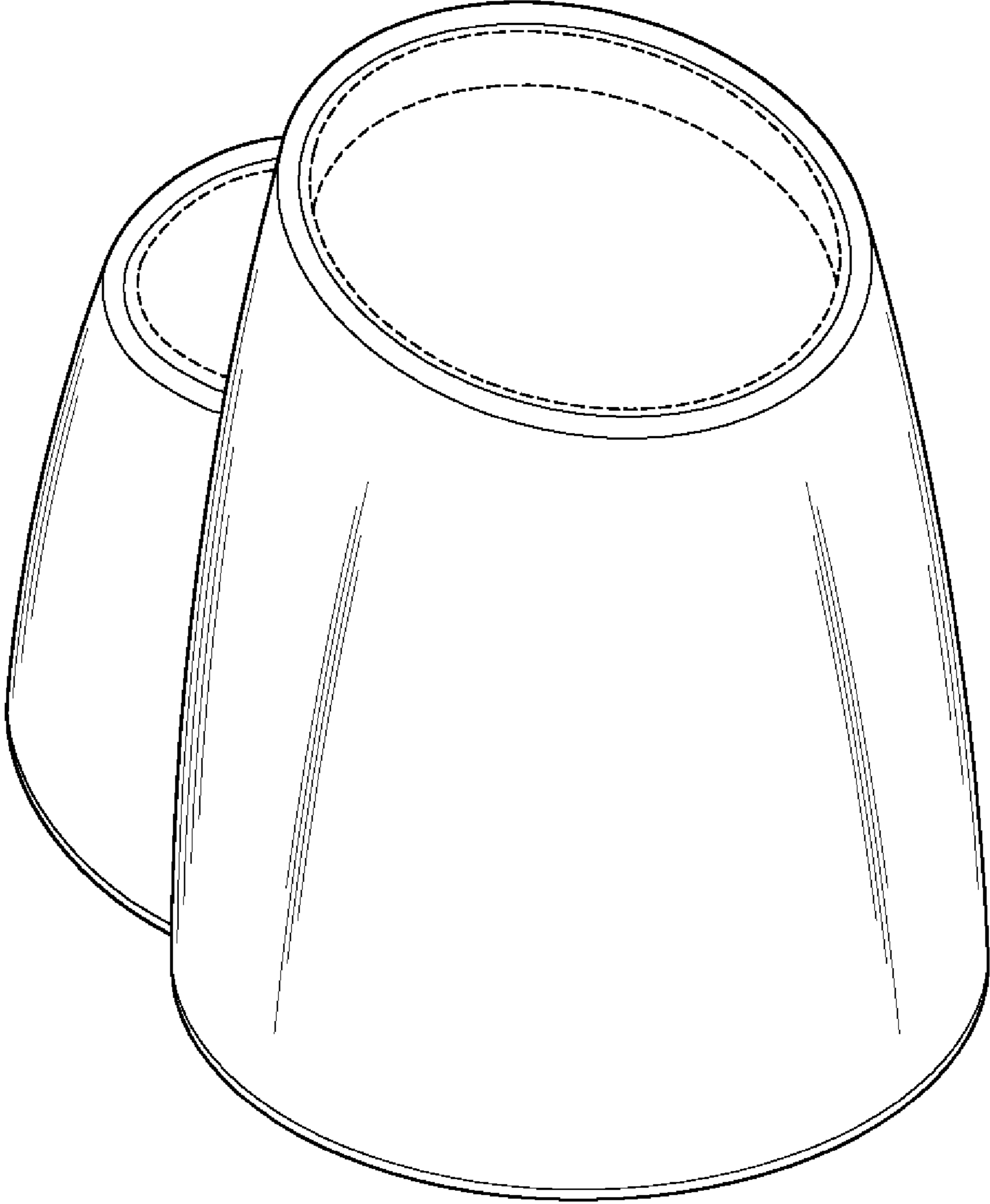

FIG. 1

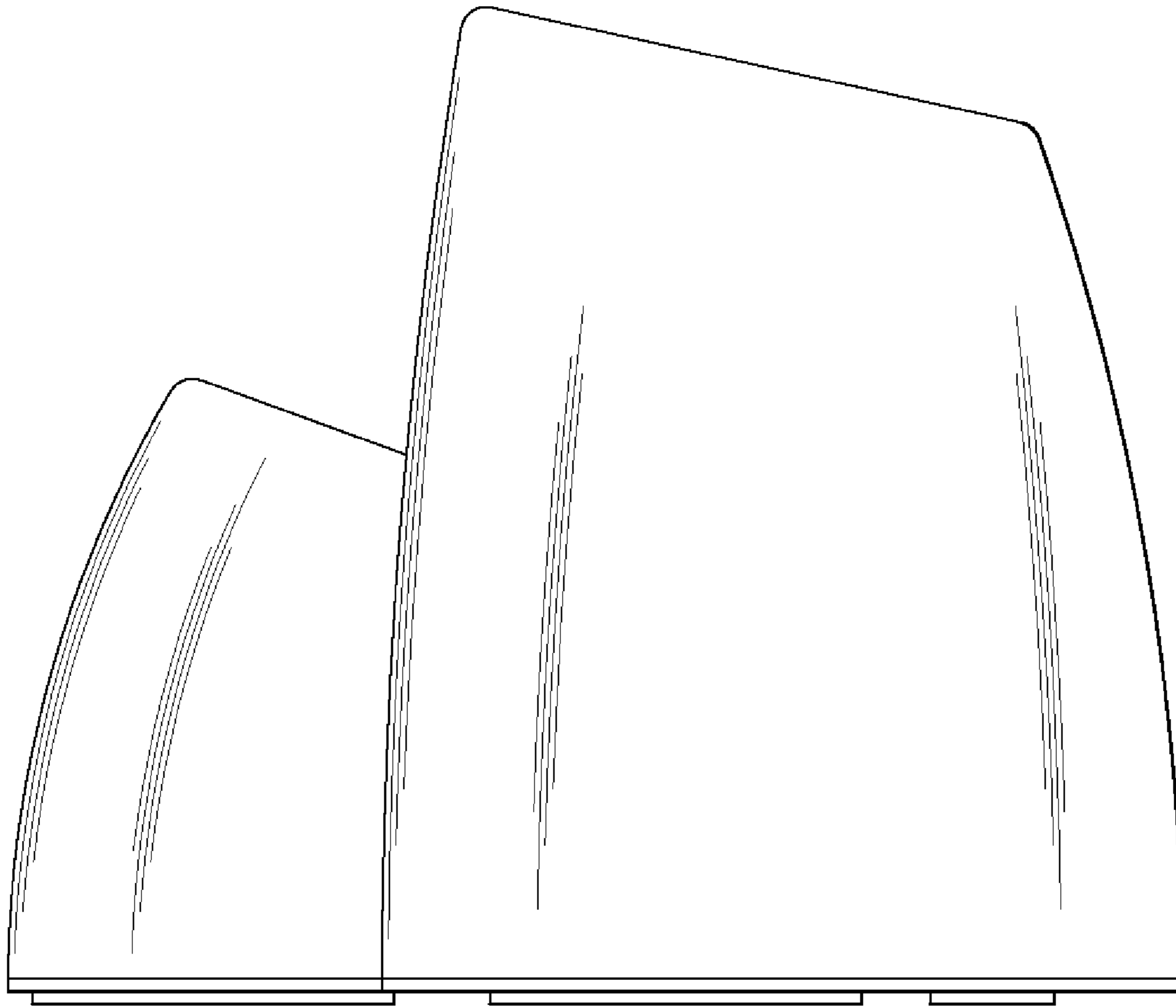

FIG. 2

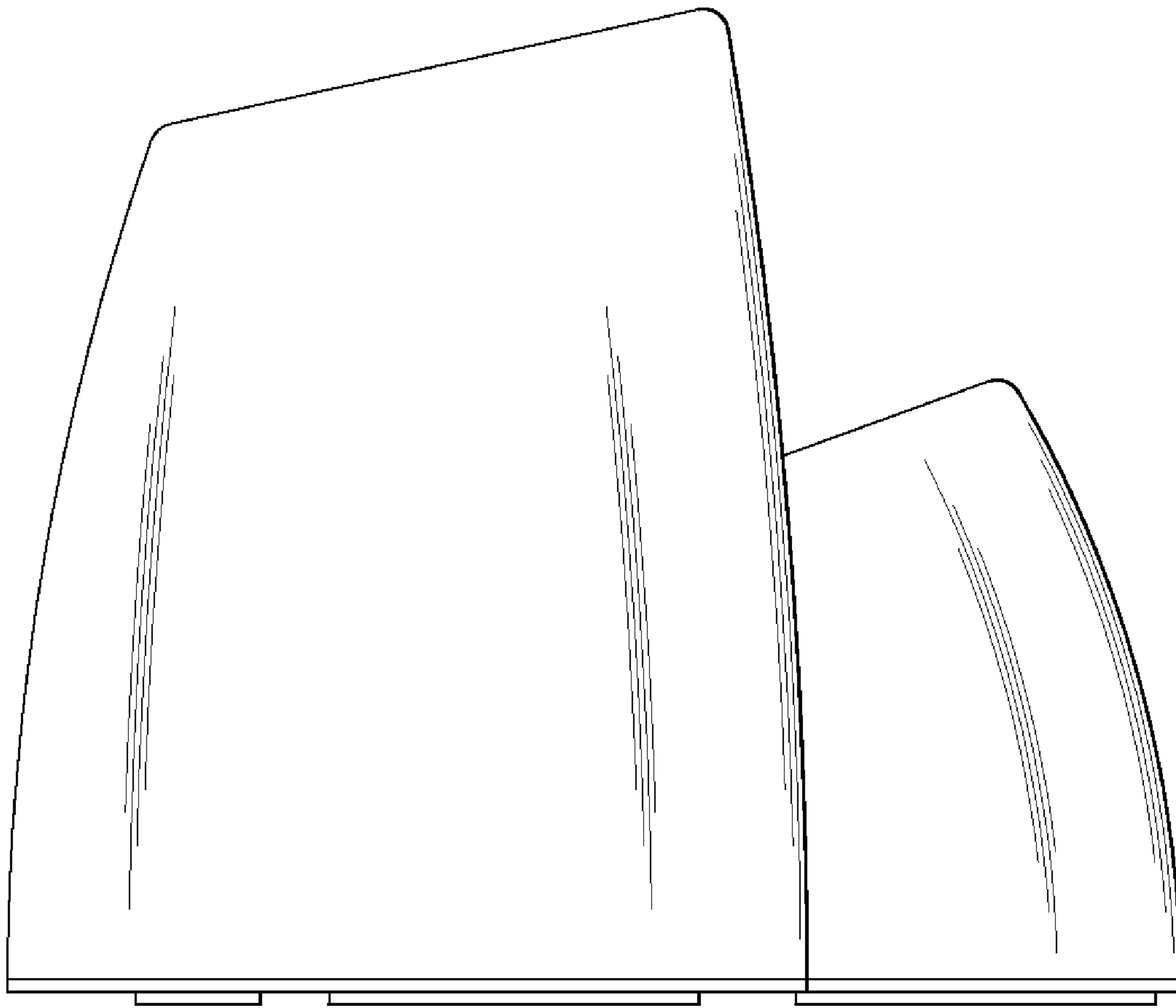

FIG. 3

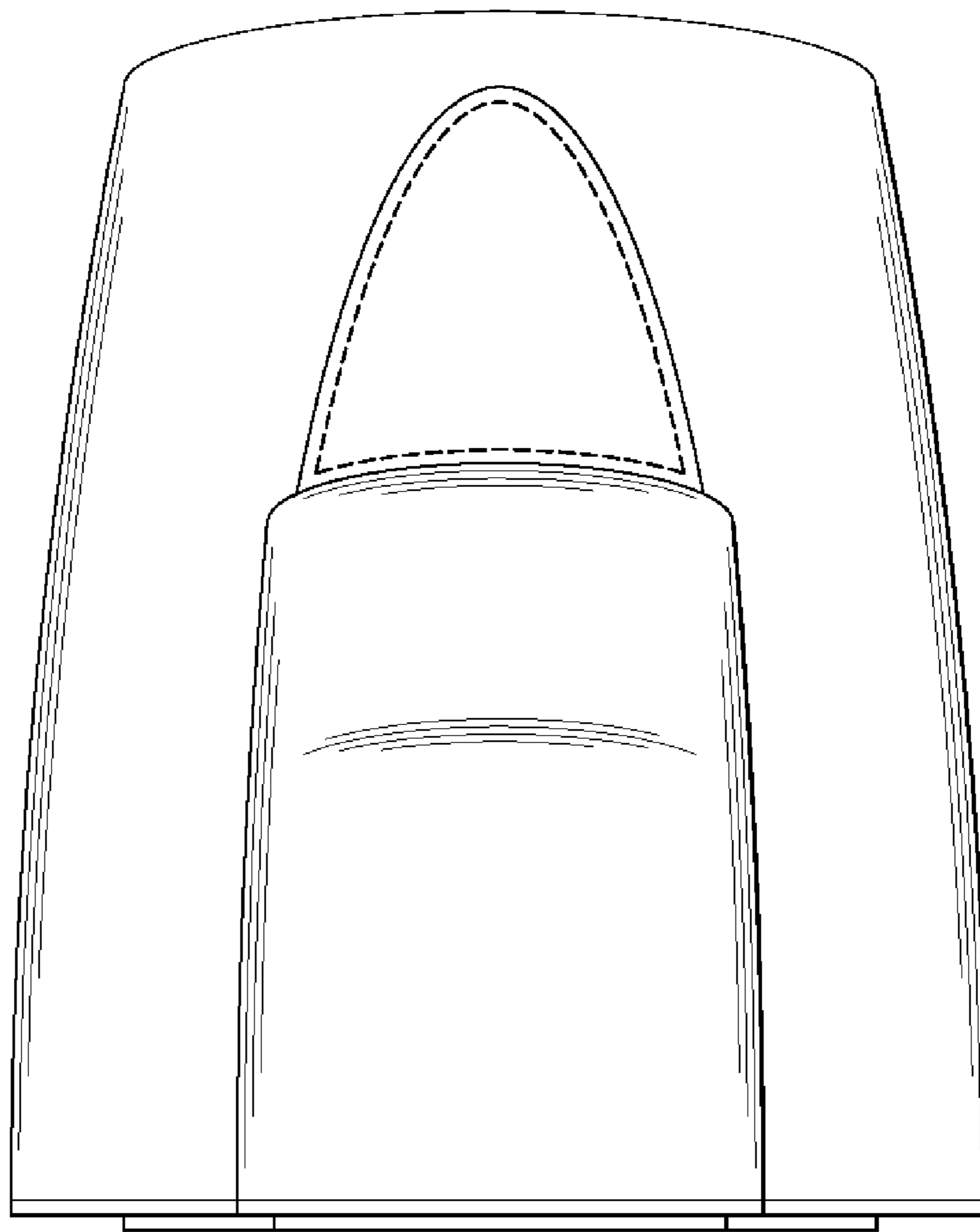

FIG. 4

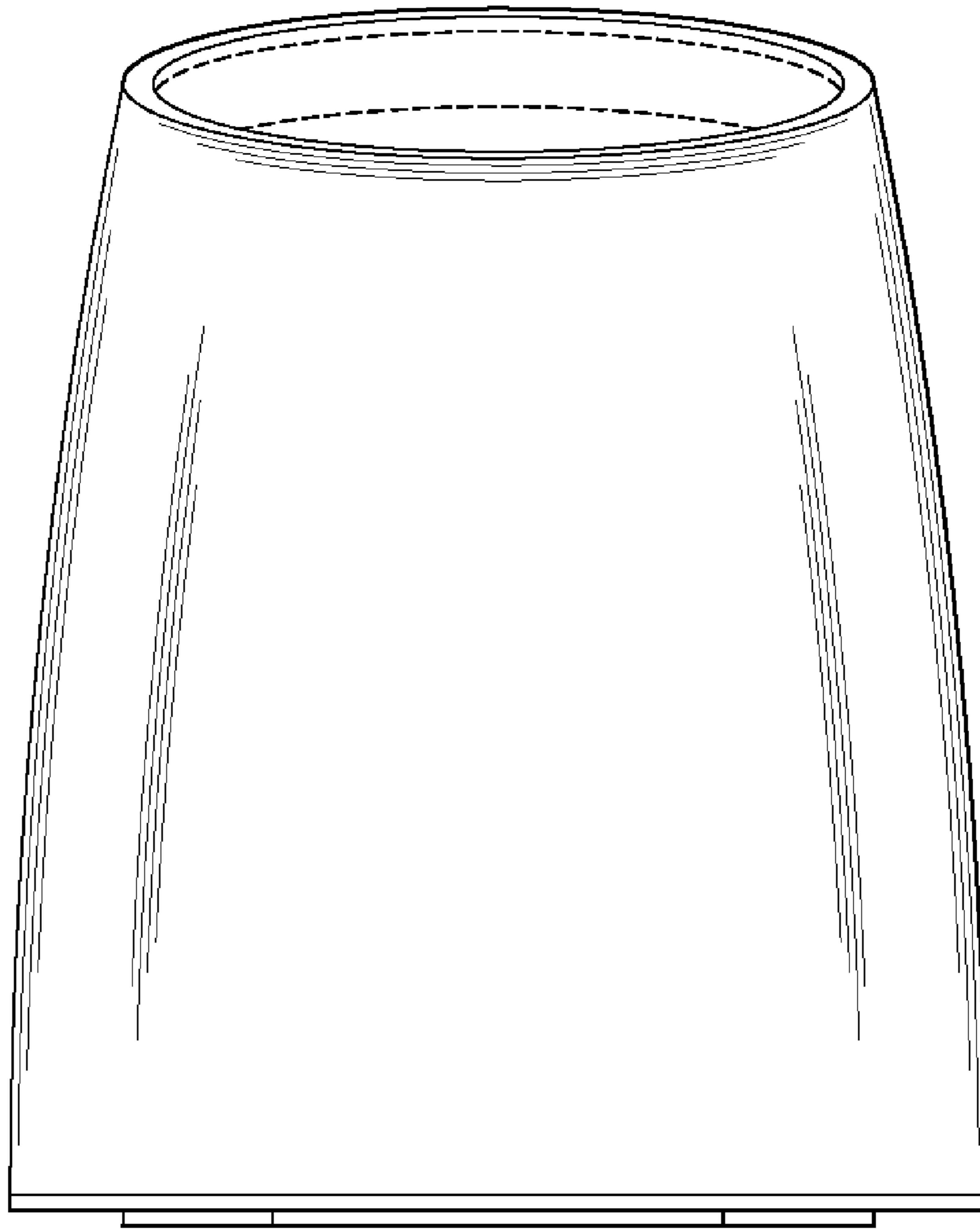

FIG. 5

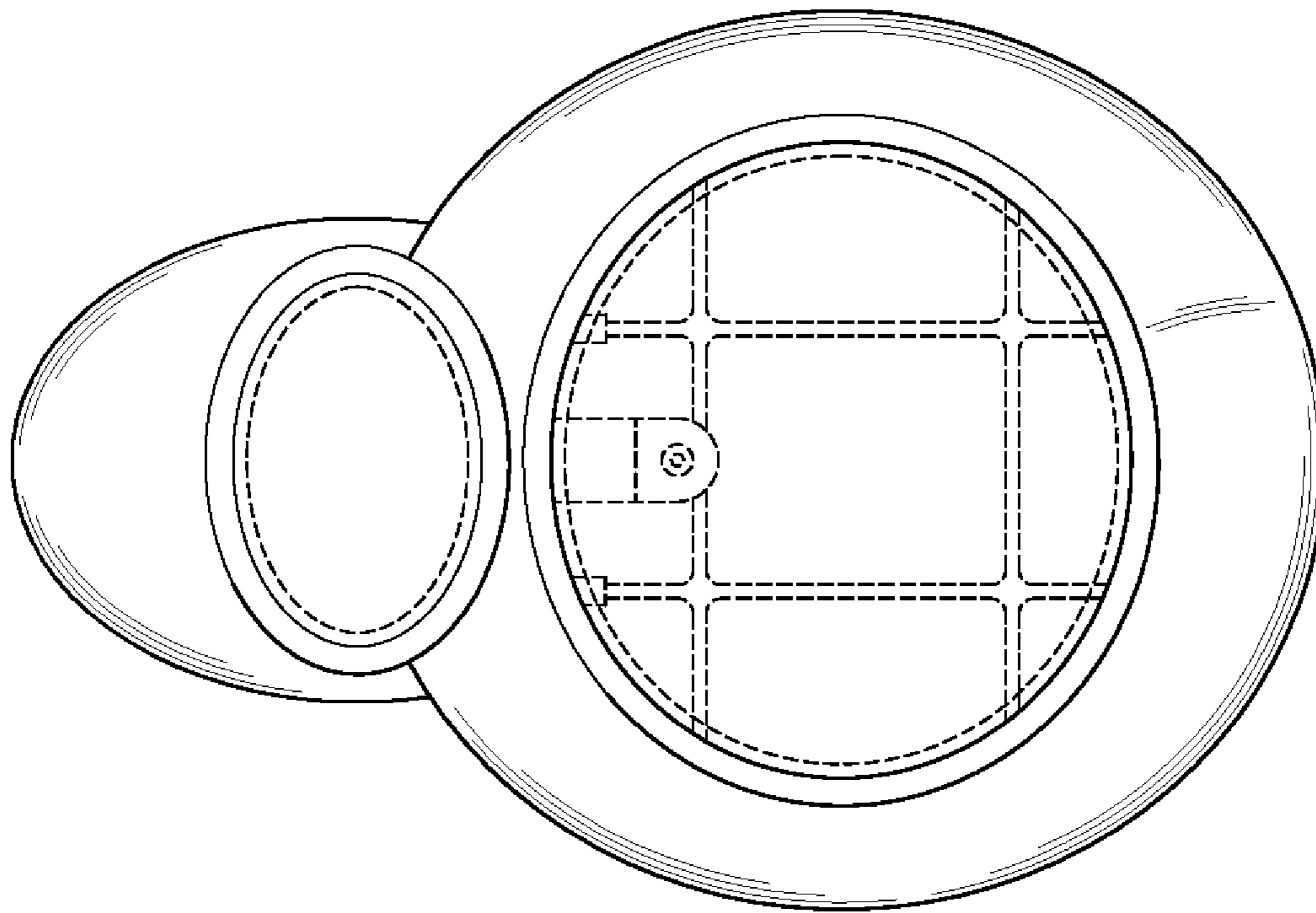

FIG. 6

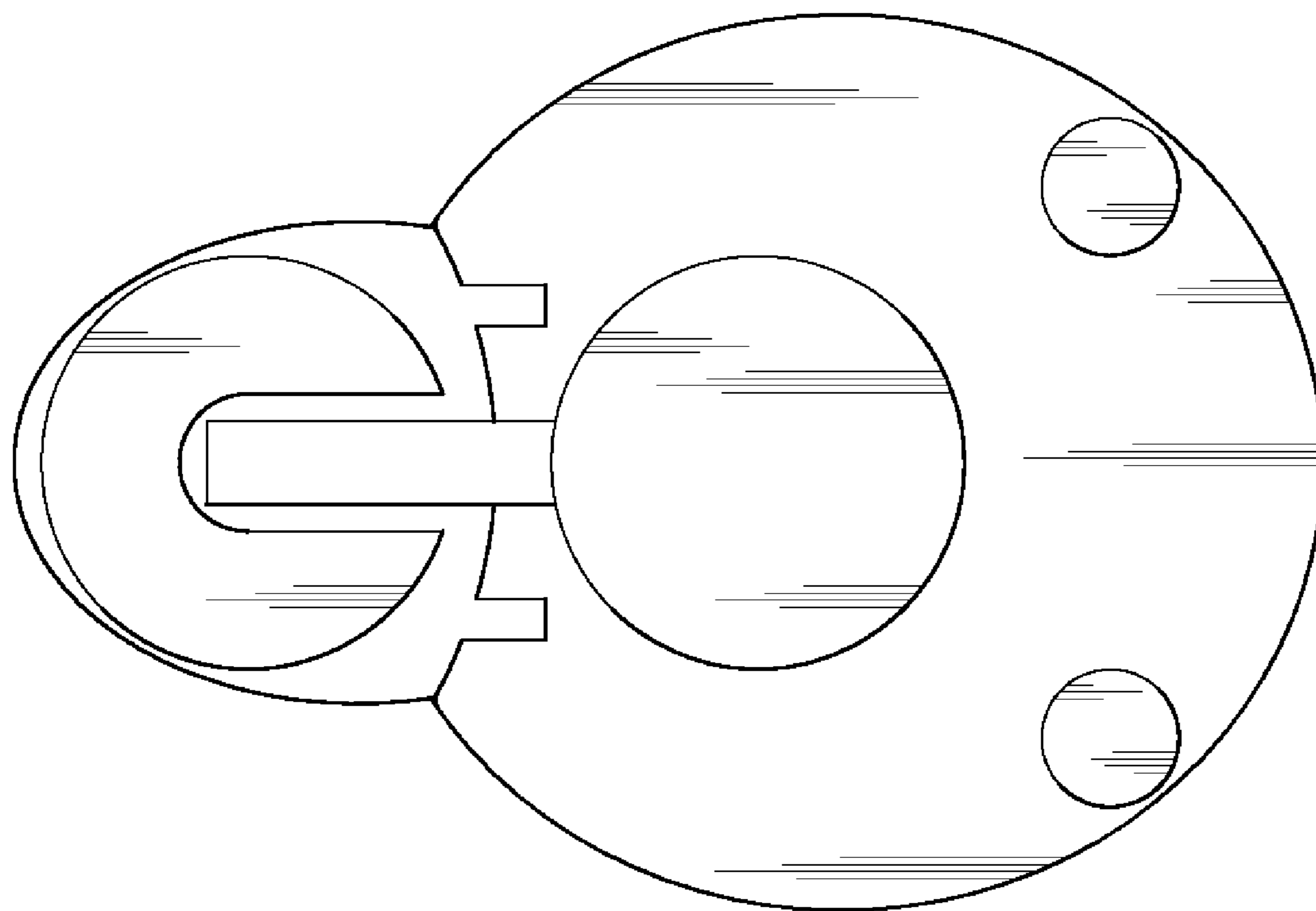

FIG. 7

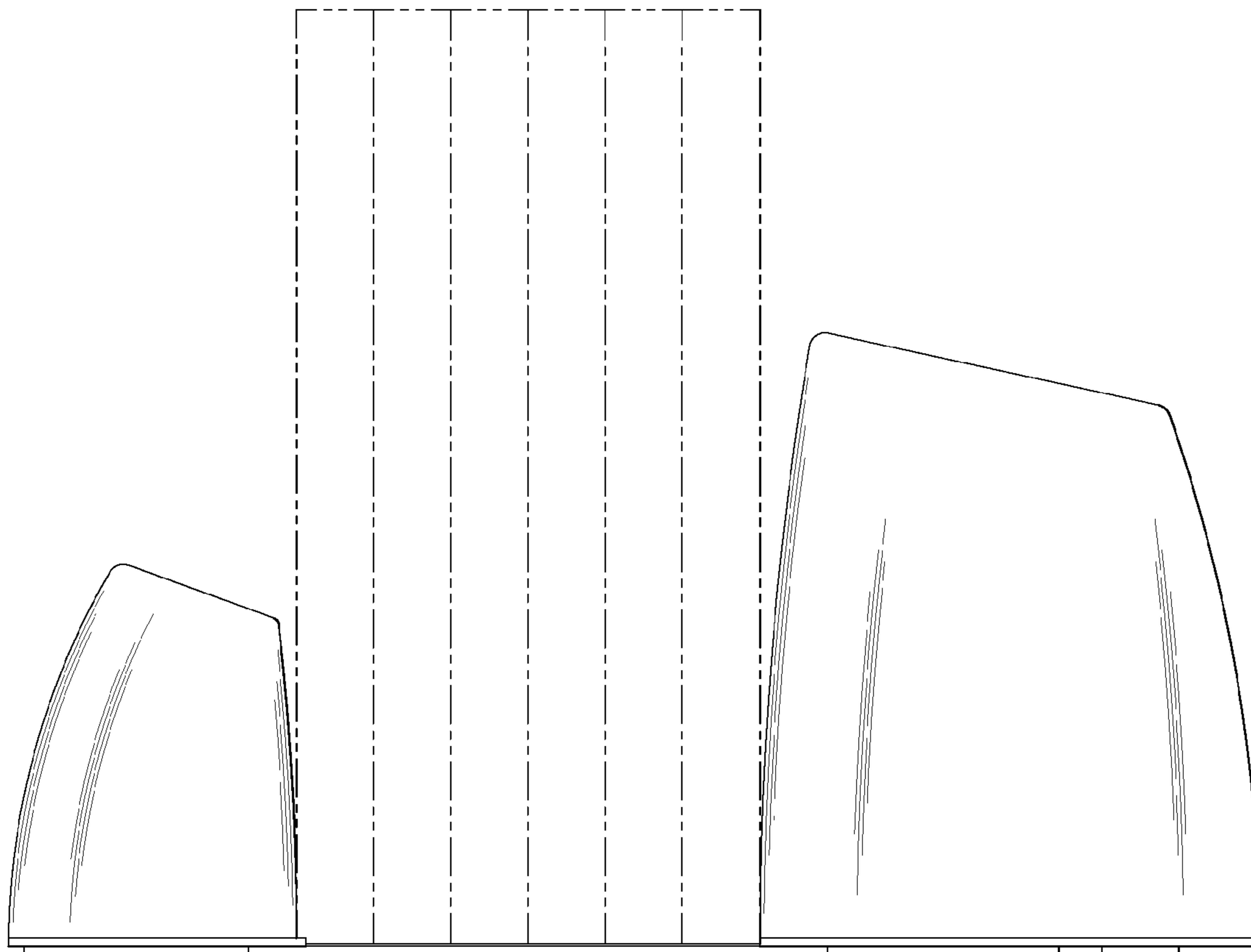

FIG. 8