

US00D560711S

(12) **United States Design Patent**  
**Robinson et al.**

(10) **Patent No.:** **US D560,711 S**  
(45) **Date of Patent:** **\*\* Jan. 29, 2008**

(54) **BANKNOTE COUNTER**

(75) Inventors: **David Robinson**, Aylesbury (GB);  
**Simon Calverley**, Waterlooville (GB);  
**Pete Holcroft**, Berkhamsted (GB);  
**David Brooks**, Waterlooville (GB);  
**Matthew Brown**, Camberley (GB);  
**Amanda Mumford**, Southampton  
(GB); **Gavin Doyle**, Portsmouth (GB)

(73) Assignee: **De la Rue International Limited**,  
Hampshire (GB)

(\*\*) Term: **14 Years**

(21) Appl. No.: **29/266,688**

(22) Filed: **Sep. 27, 2006**

(30) **Foreign Application Priority Data**

Jun. 27, 2006 (EM) ..... 000553706-0001  
Jun. 27, 2006 (EM) ..... 000553706-0002

(51) **LOC (8) Cl.** ..... **18-01**

(52) **U.S. Cl.** ..... **D18/3.3; D18/4.1; D18/47**

(58) **Field of Classification Search** ..... D18/3.1,  
D18/3.2, 3.3, 4.1, 4.2, 4.3, 4.4, 12.1, 46, 49;  
D99/28, 99, 34, 35; 209/534; 235/379;  
382/135

See application file for complete search history.

(56) **References Cited**

**U.S. PATENT DOCUMENTS**

D369,984 S \* 5/1996 Larsen ..... D10/97  
D377,766 S \* 2/1997 Hidaka et al. .... D18/3.3  
D427,623 S \* 7/2000 Kuwada et al. .... D18/3.1  
D439,604 S \* 3/2001 Takagi et al. .... D18/3.3  
D452,973 S \* 1/2002 Kuwada ..... D18/3.3  
D457,554 S \* 5/2002 Takagi et al. .... D18/3.3

6,493,461 B1 \* 12/2002 Mennie et al. .... 382/135  
6,908,029 B2 \* 6/2005 Numata et al. .... 235/375  
6,980,684 B1 \* 12/2005 Munro et al. .... 382/135  
D539,332 S \* 3/2007 Gonzalez ..... D18/3.3

\* cited by examiner

*Primary Examiner*—Daniel Bui  
*Assistant Examiner*—Elizabeth J Oswecki  
(74) *Attorney, Agent, or Firm*—Oliff & Berridge, PLC

(57) **CLAIM**

The ornamental design for a banknote counter, as shown and described.

**DESCRIPTION**

FIG. 1 is a perspective view of a banknote counter with the handle shown in a closed position;

FIG. 2 is a front elevational view thereof;

FIG. 3 is a top plan view thereof;

FIG. 4 is a left side elevational view thereof;

FIG. 5 is a right side elevational view thereof;

FIG. 6 is a rear elevational view thereof;

FIG. 7 is a bottom plan view thereof.

FIG. 8 is a perspective view of a banknote counter with the handle shown in an open position;

FIG. 9 is a front elevational view thereof;

FIG. 10 is a top plan view thereof;

FIG. 11 is a left side elevational view thereof;

FIG. 12 is a right side elevational view thereof; and,

FIG. 13 is a rear elevational view thereof.

The broken lines are for illustrative purposes only and form no part of the claimed design.

**1 Claim, 13 Drawing Sheets**

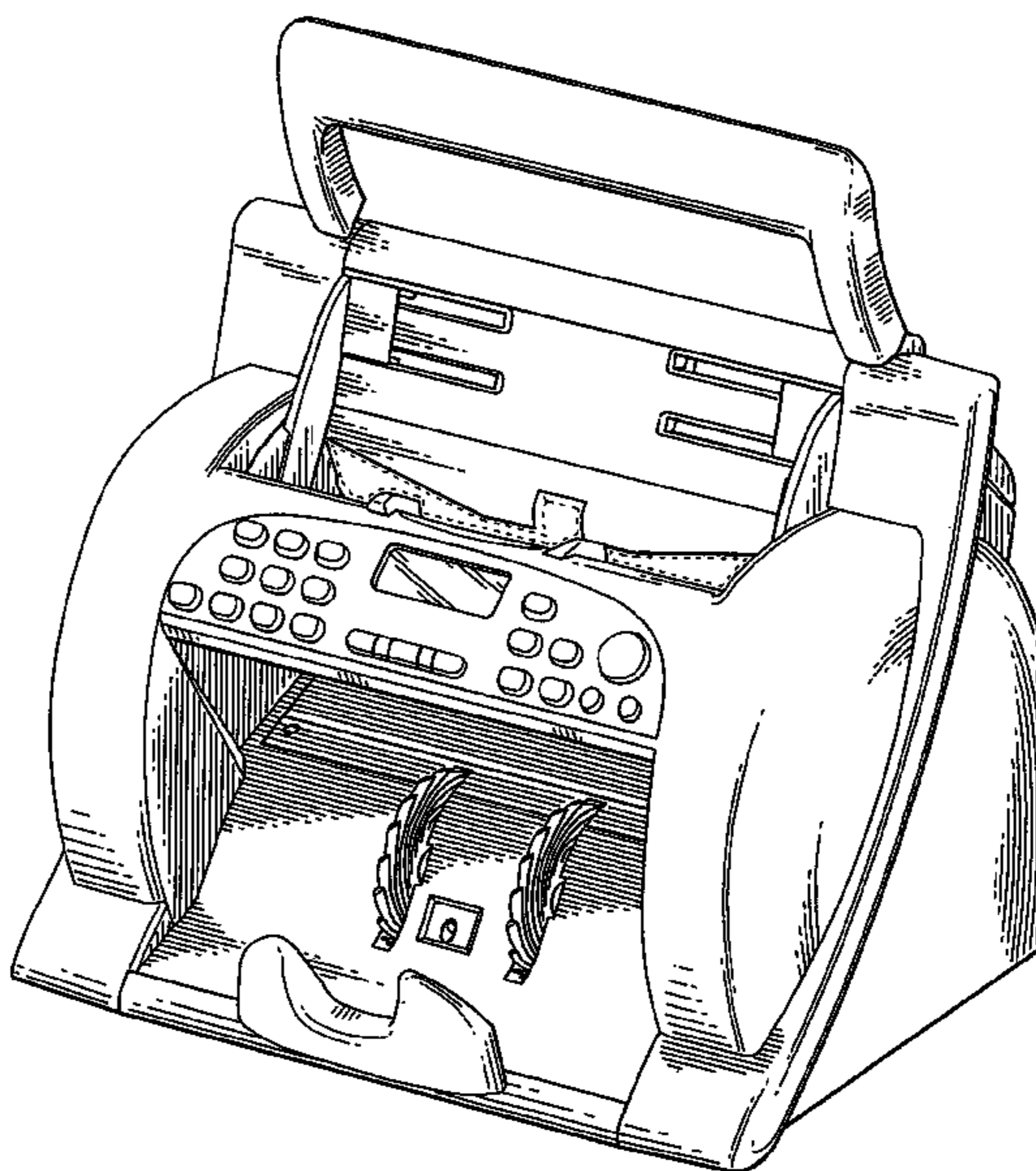
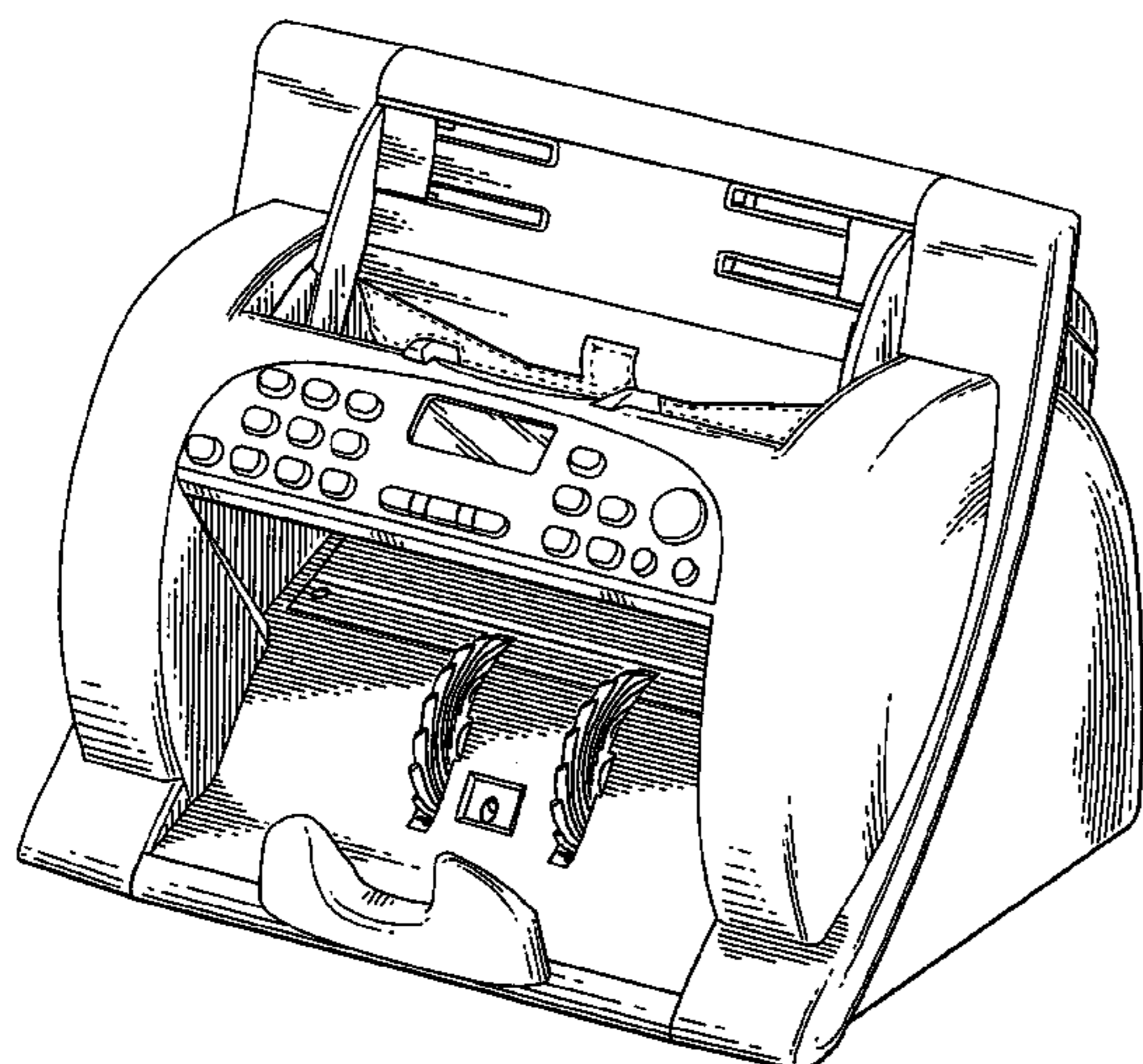

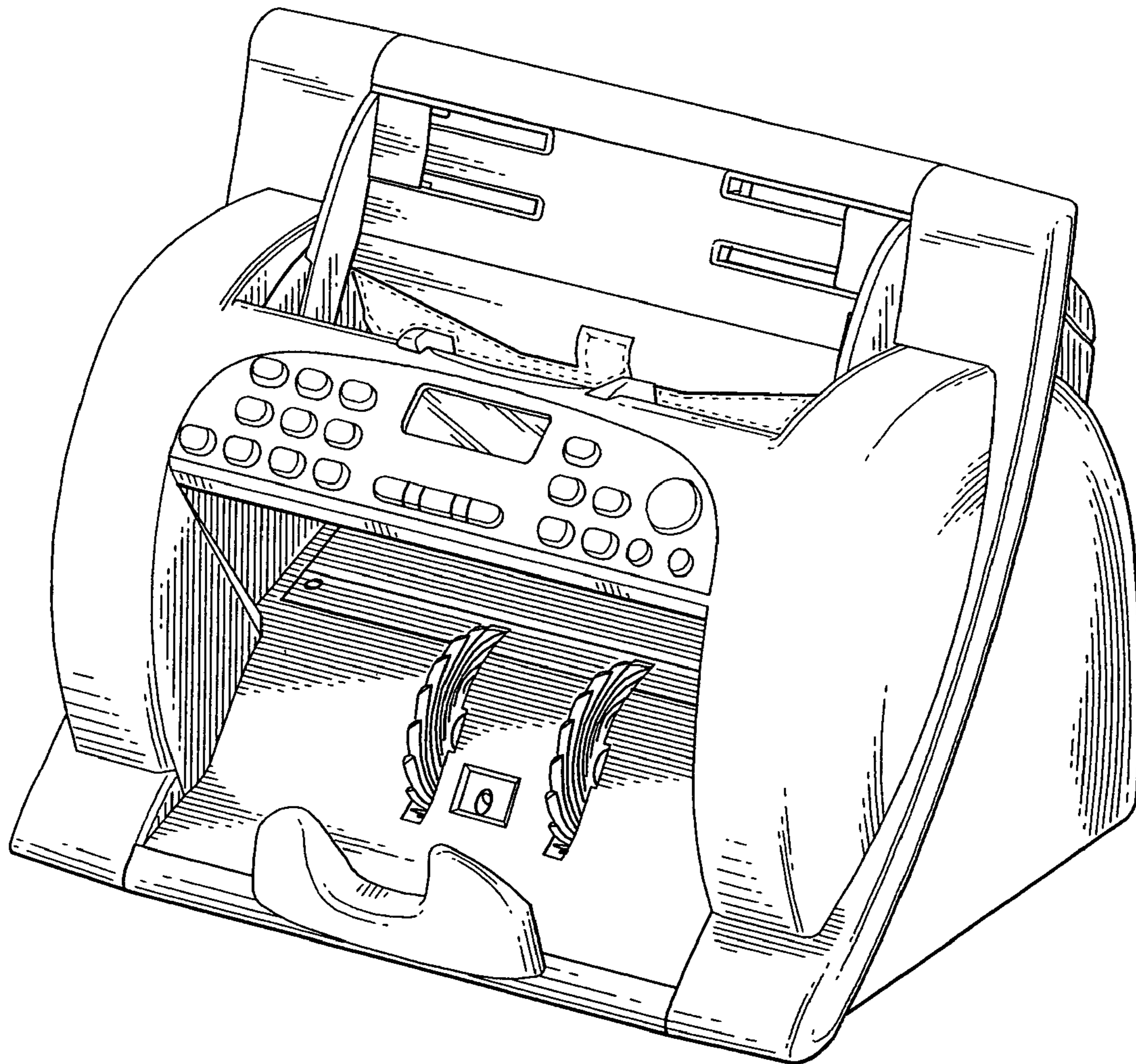

FIG. 1

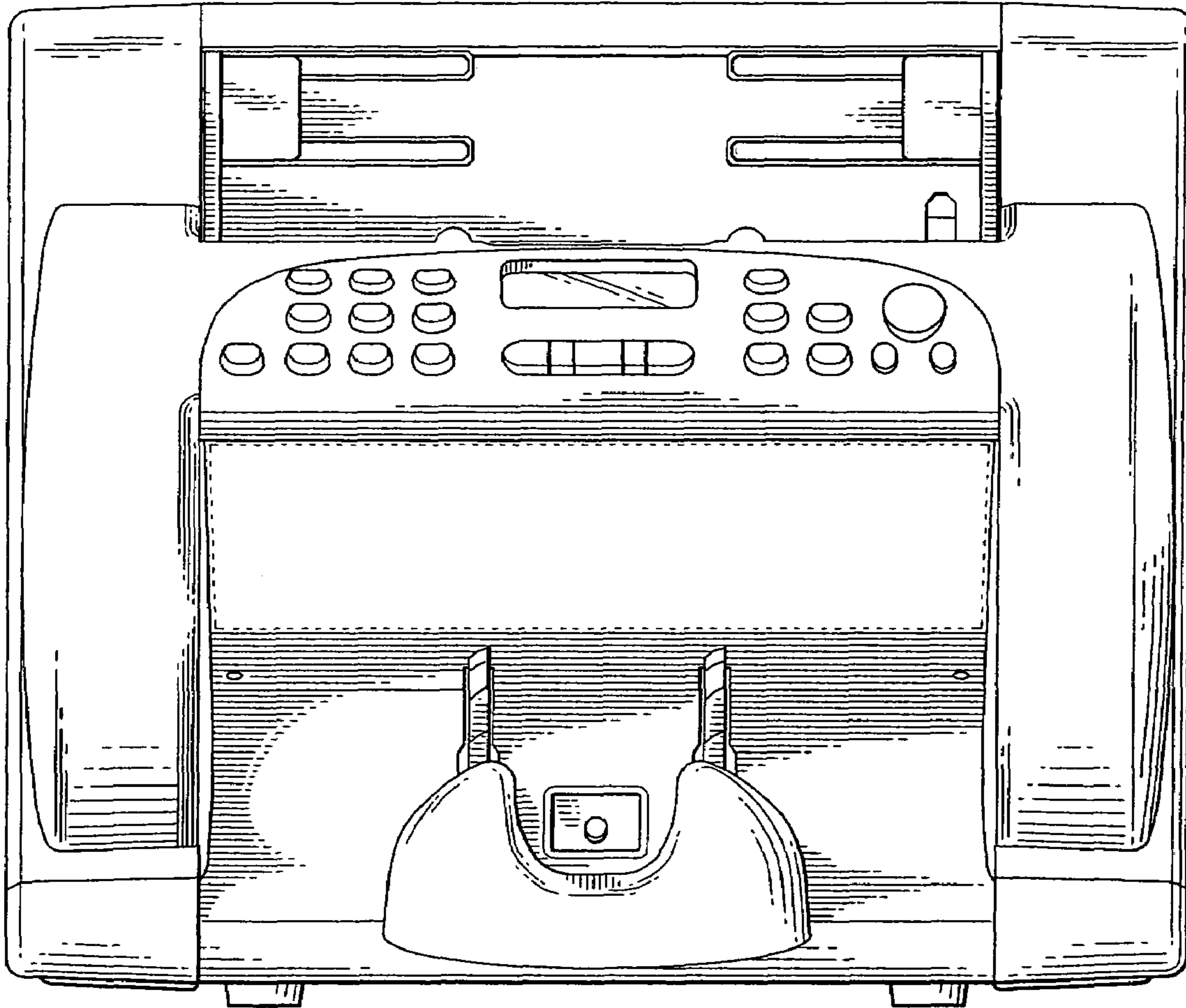

FIG. 2

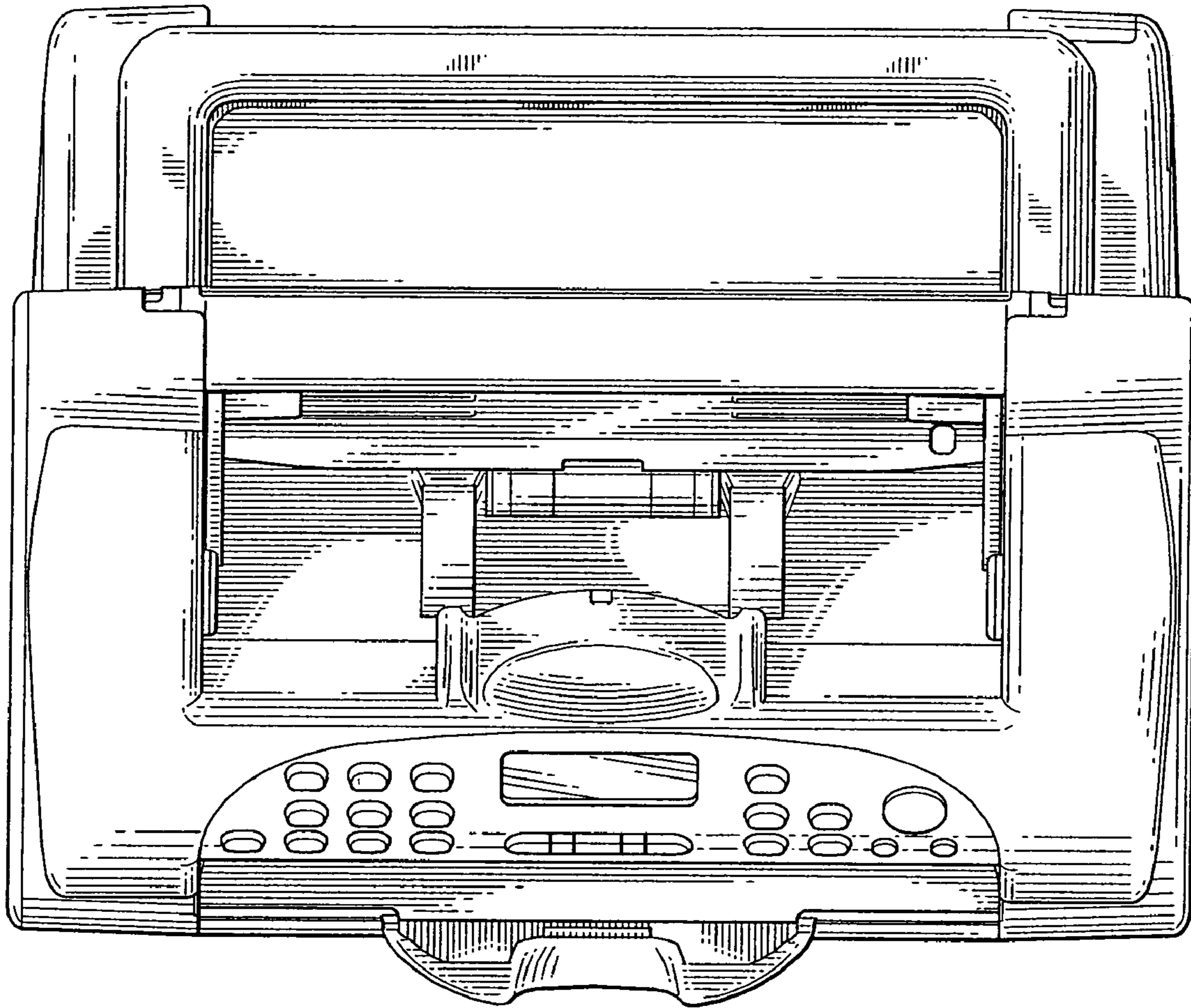

FIG. 3

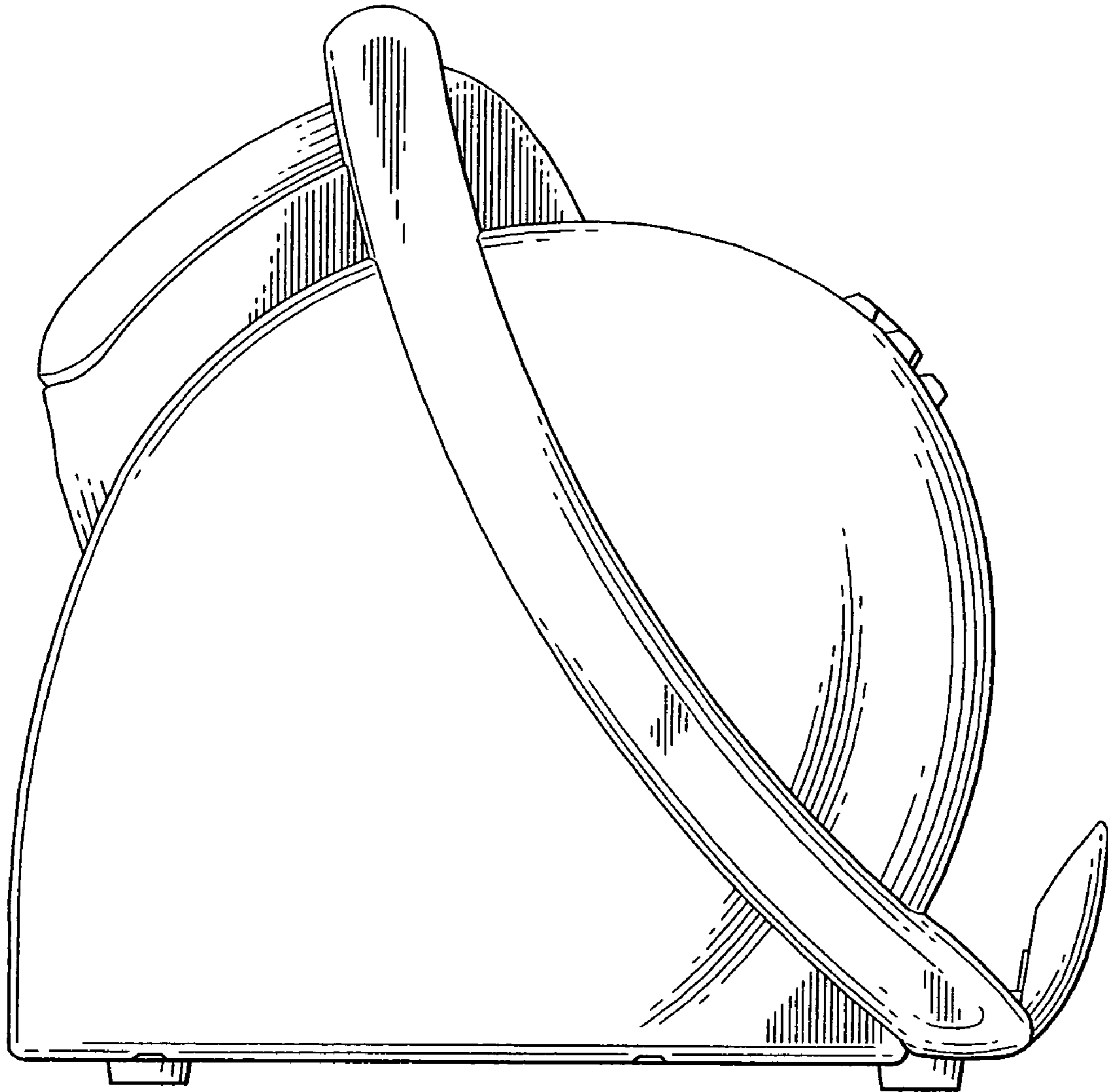

FIG. 4

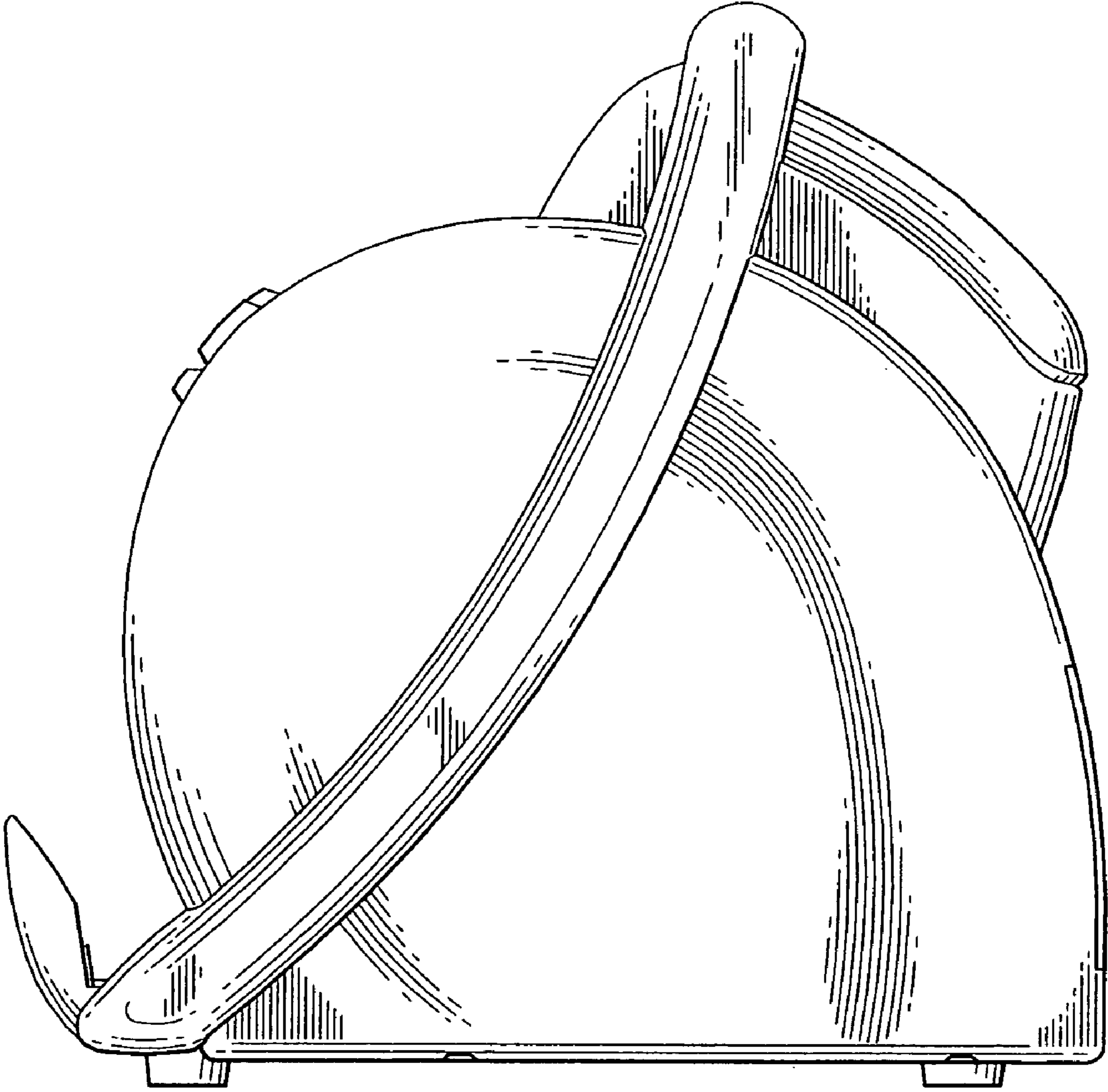

FIG. 5

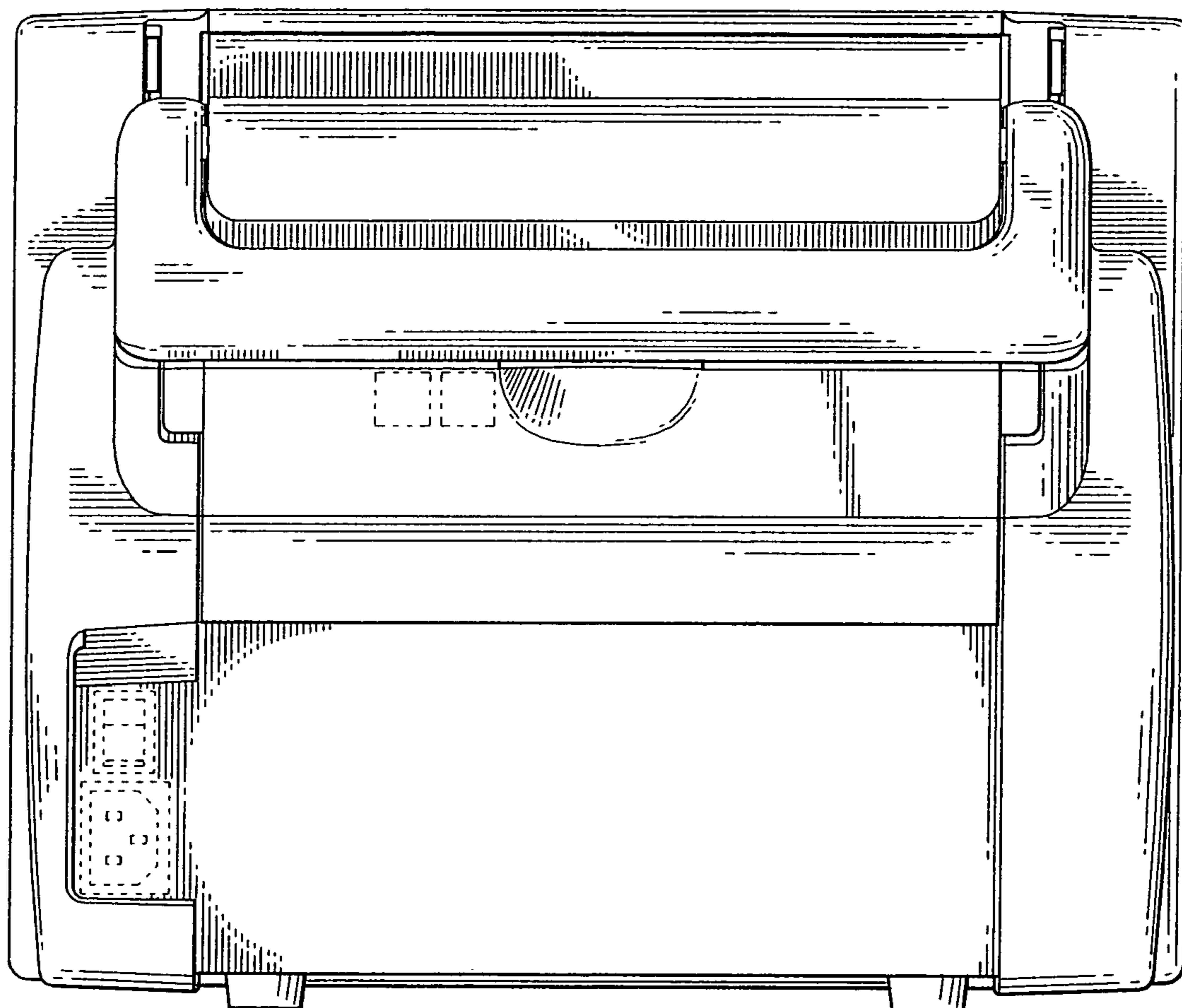

FIG. 6

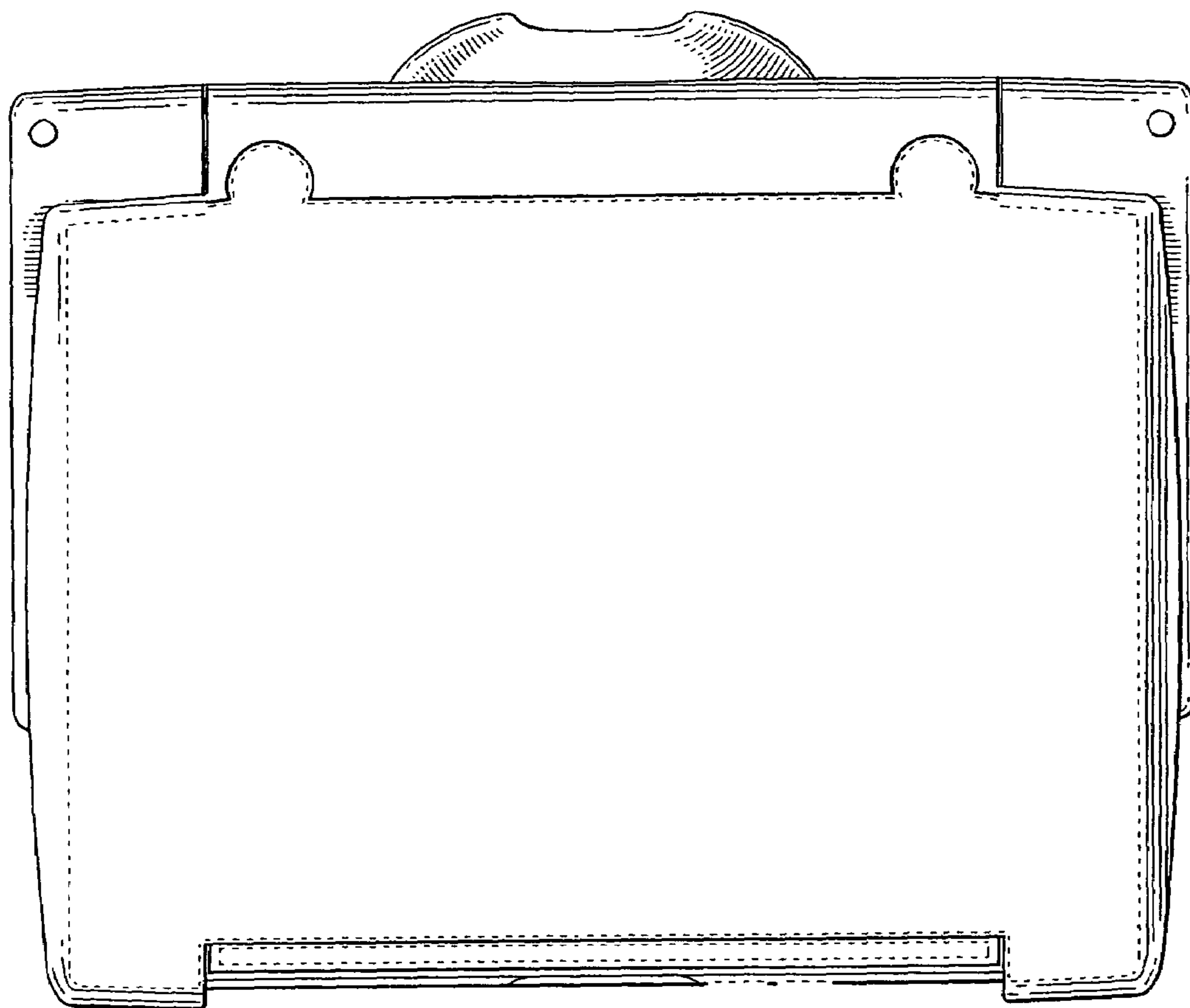

FIG. 7



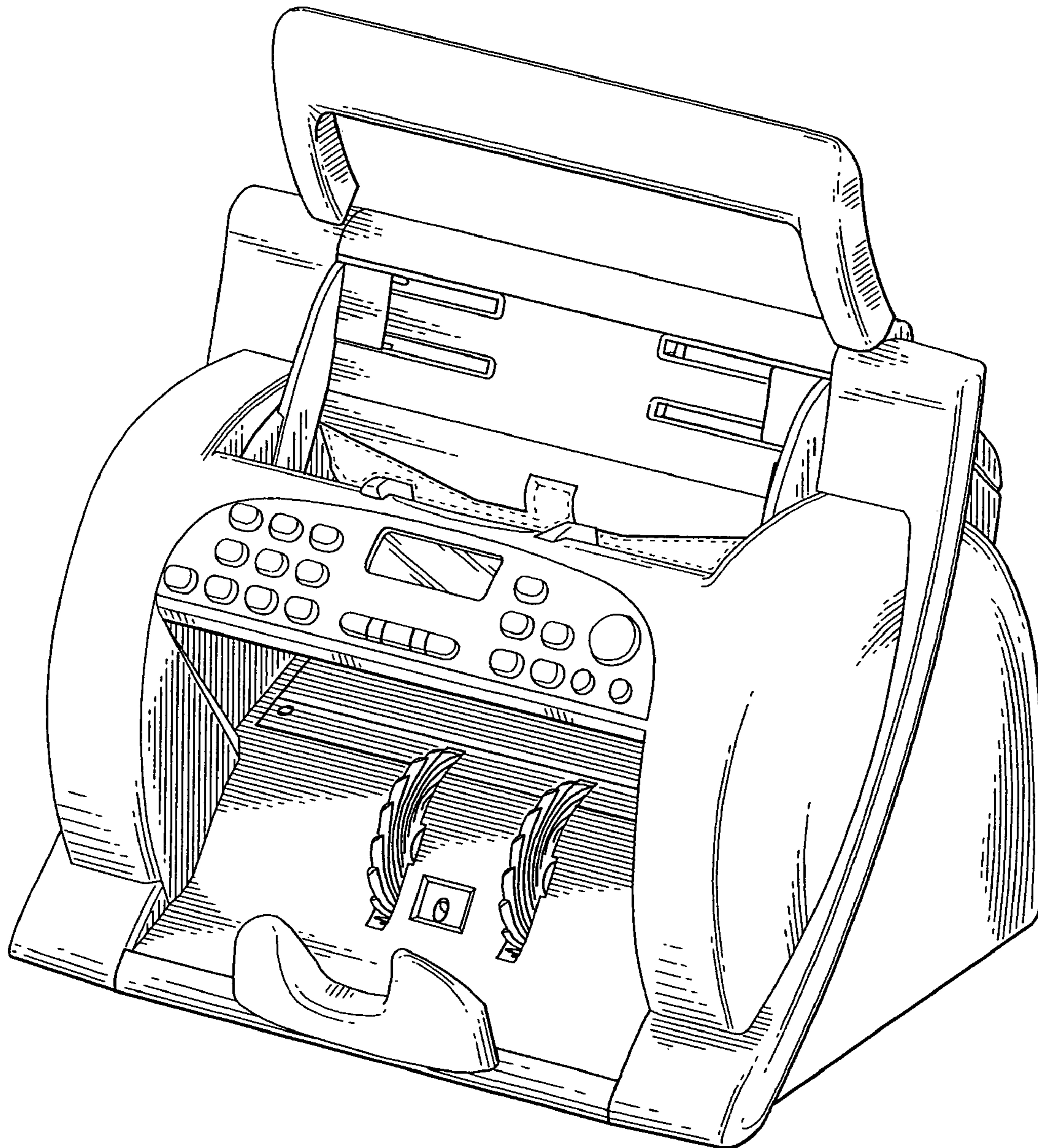

FIG. 8

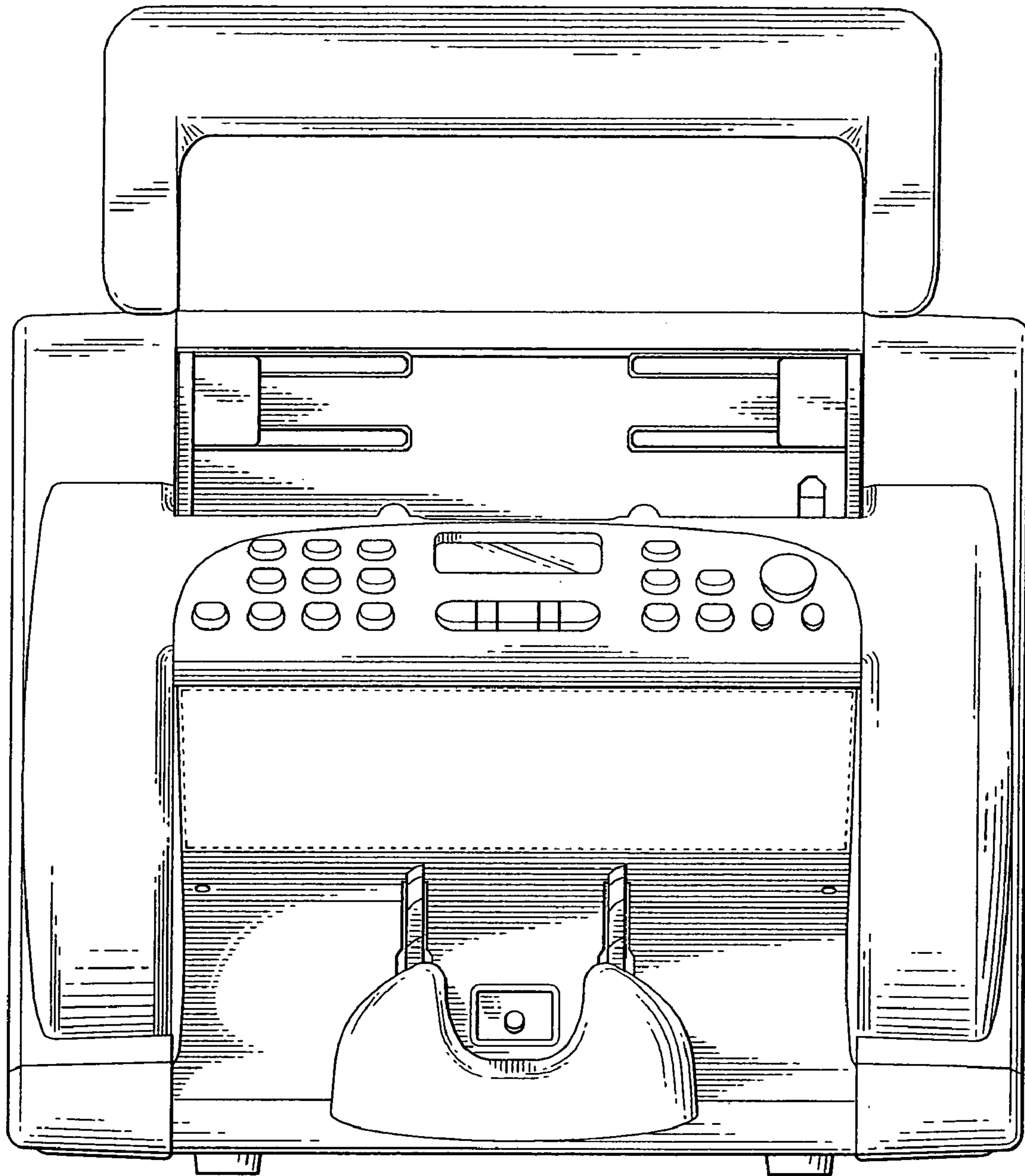

FIG. 9

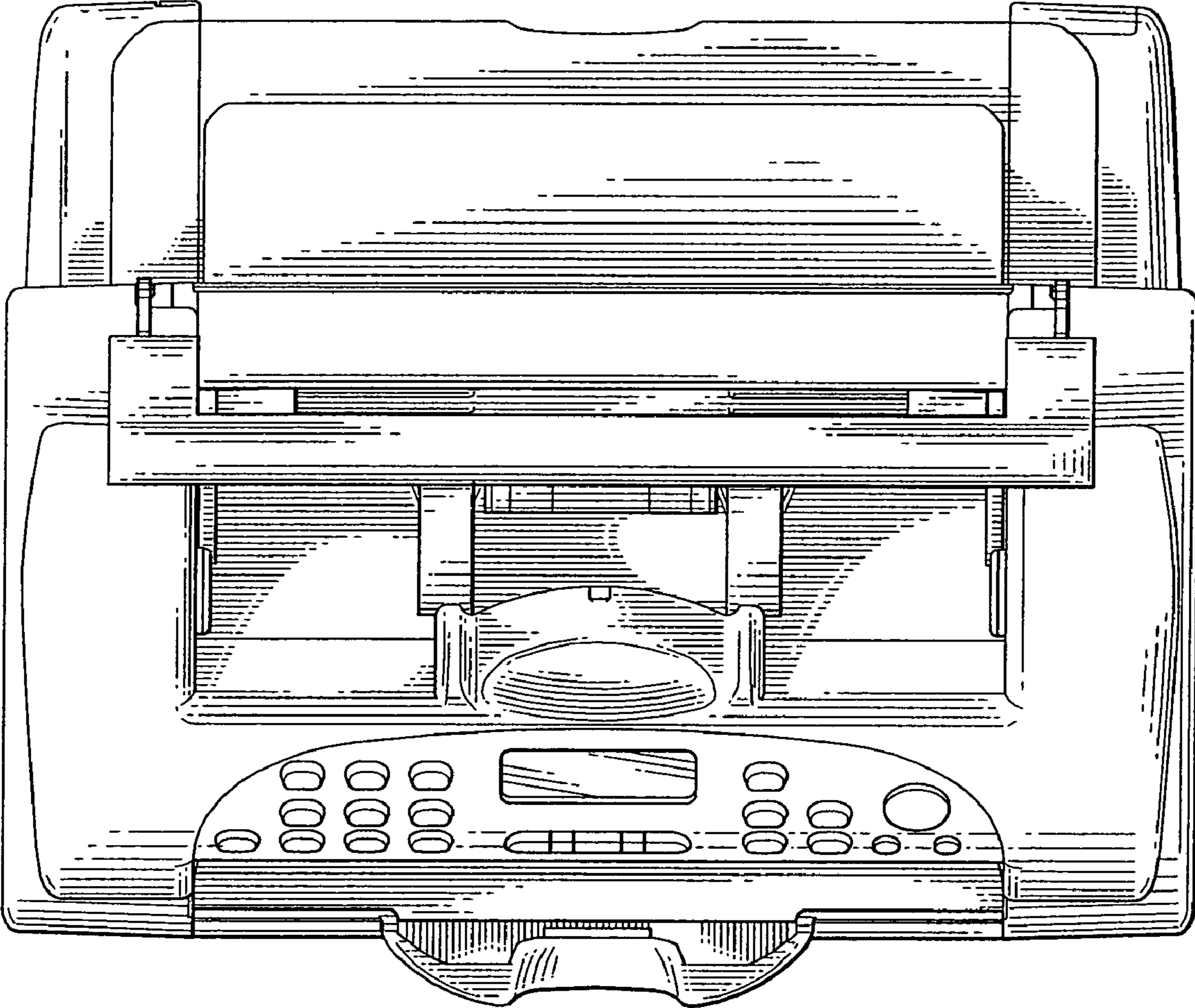

FIG. 10

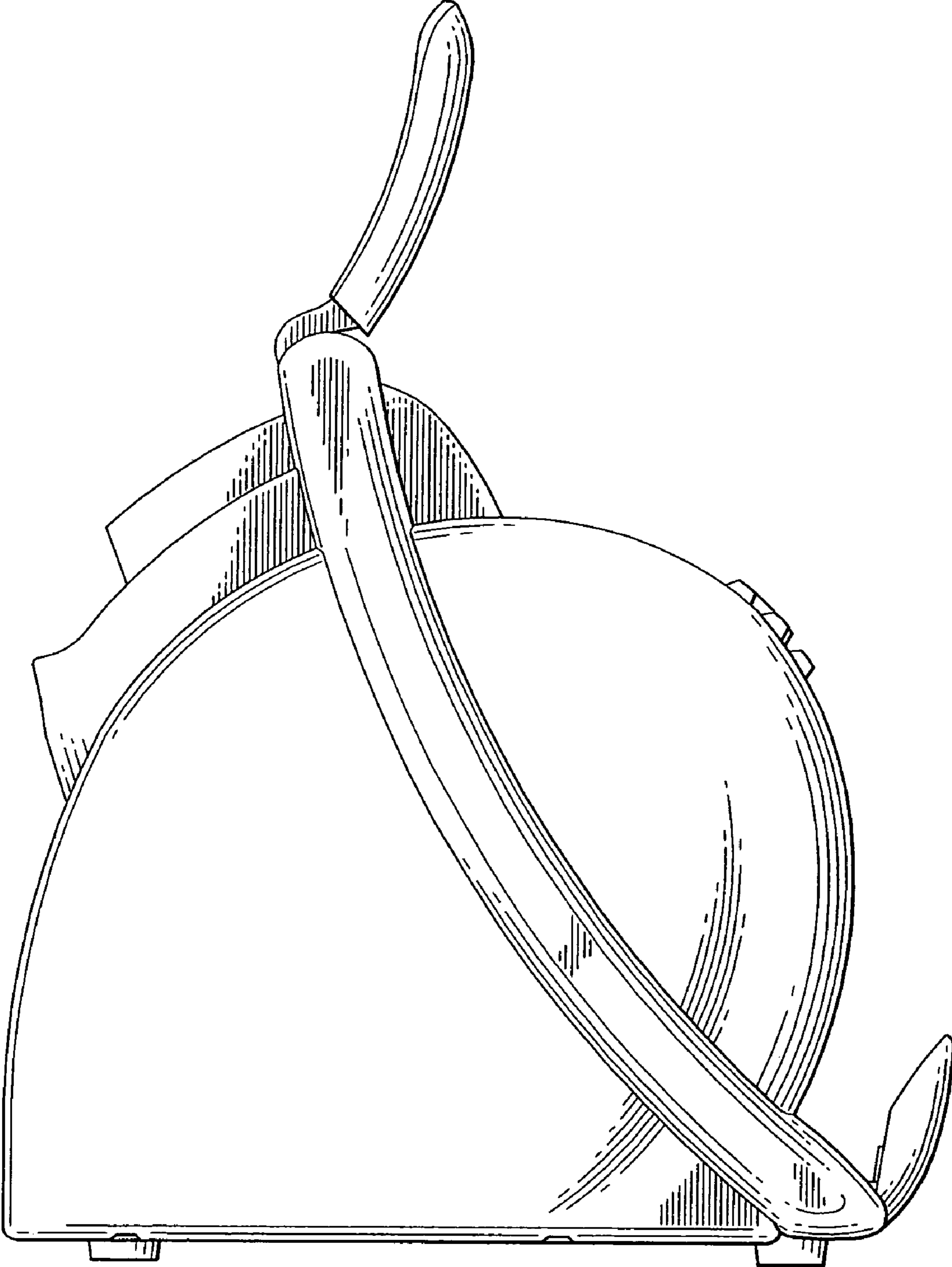

FIG. 11

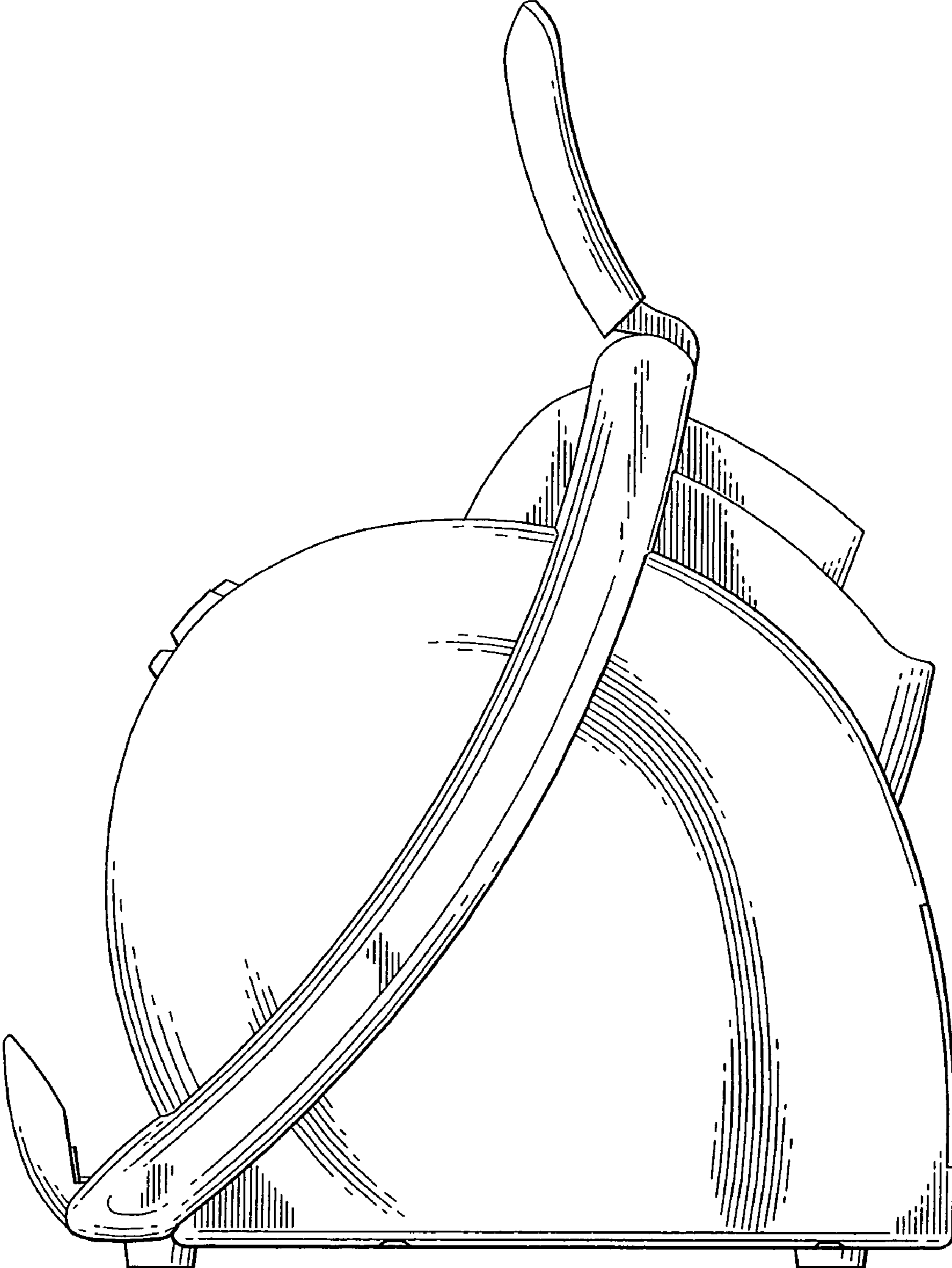

FIG. 12

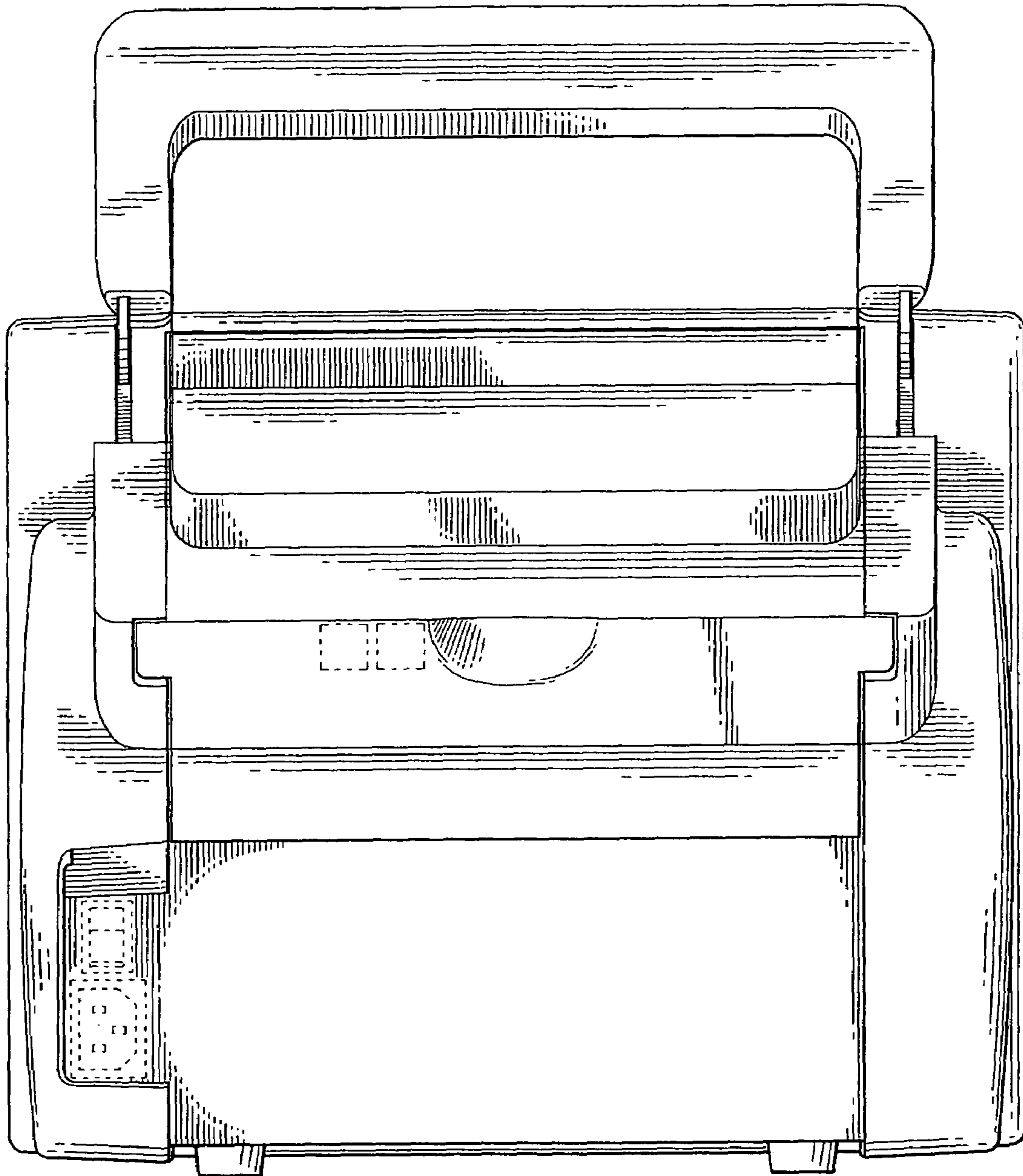

FIG. 13