

US00D560485S

(12) **United States Design Patent**
Lavelle

(10) **Patent No.:** **US D560,485 S**
(45) **Date of Patent:** **** Jan. 29, 2008**

(54) **STOPPER FOOT AND CORNER SHIELD**

(57) **CLAIM**

(76) Inventor: **Richard M. Lavelle**, 2662 Ravenwood Ct., Wexford, PA (US) 15090

I claim the ornamental design for a stopper foot and corner shield, as shown and described.

(**) Term: **14 Years**

DESCRIPTION

(21) Appl. No.: **29/277,671**

FIG. 1 is a perspective view of a stopper foot and corner shield, showing my design;

(22) Filed: **Mar. 6, 2007**

FIG. 2 is a top view of the stopper foot and corner shield of FIG. 1;

(51) **LOC (8) Cl.** **08-09**

FIG. 3 is a bottom view of the stopper foot and corner shield of FIG. 1;

(52) **U.S. Cl.** **D8/402**

FIG. 4 is a front elevation of the stopper foot and corner shield of FIG. 1;

(58) **Field of Classification Search** D8/400, D8/402, 403; D24/217, 229, 227; 428/99, 428/122; 229/199; 206/453, 586, 557-567

See application file for complete search history.

FIG. 5 is a rear elevation of the stopper foot and corner shield of FIG. 1;

(56) **References Cited**

U.S. PATENT DOCUMENTS

FIG. 6 is a left elevation of the stopper foot and corner shield of FIG. 1;

2,080,630 A * 5/1937 Nathanson 206/459.5

FIG. 7 is a right elevation of the stopper foot and corner shield of FIG. 1;

3,137,087 A * 6/1964 Shroyer 248/345.1

FIG. 8 is a perspective view of another embodiment of the stopper foot and corner shield, showing my design;

D249,314 S * 9/1978 Wilde et al. D8/403

FIG. 9 is a top view of the stopper foot and corner shield of FIG. 8;

D260,590 S * 9/1981 Hobson D8/403

FIG. 10 is a bottom view of the stopper foot and corner shield of FIG. 8;

4,851,286 A 7/1989 Maurice

FIG. 11 is a front elevation of the stopper foot and corner shield of FIG. 8;

D416,476 S * 11/1999 Engberg D8/402

FIG. 12 is a rear elevation view of the stopper foot and corner shield of FIG. 8;

6,368,694 B1 * 4/2002 Marsh et al. 428/99

FIG. 13 is a left elevation of the stopper foot and corner shield of FIG. 8; and,

6,470,637 B2 * 10/2002 Gratz 52/287.1

FIG. 14 is a right elevation of the stopper foot and corner shield of FIG. 8.

6,478,354 B1 * 11/2002 Eyal 294/74

D537,337 S * 2/2007 Brockington et al. D8/499

2005/0244316 A1 11/2005 Davis

2006/0243636 A1 * 11/2006 Robichaud et al. 206/586

FOREIGN PATENT DOCUMENTS

WO WO 2007/019233 2/2007

* cited by examiner

Primary Examiner—Cathron C. Brooks

Assistant Examiner—Barbara Fox

(74) *Attorney, Agent, or Firm*—Trego, Hines & Ladenheim, PLLC

1 Claim, 8 Drawing Sheets

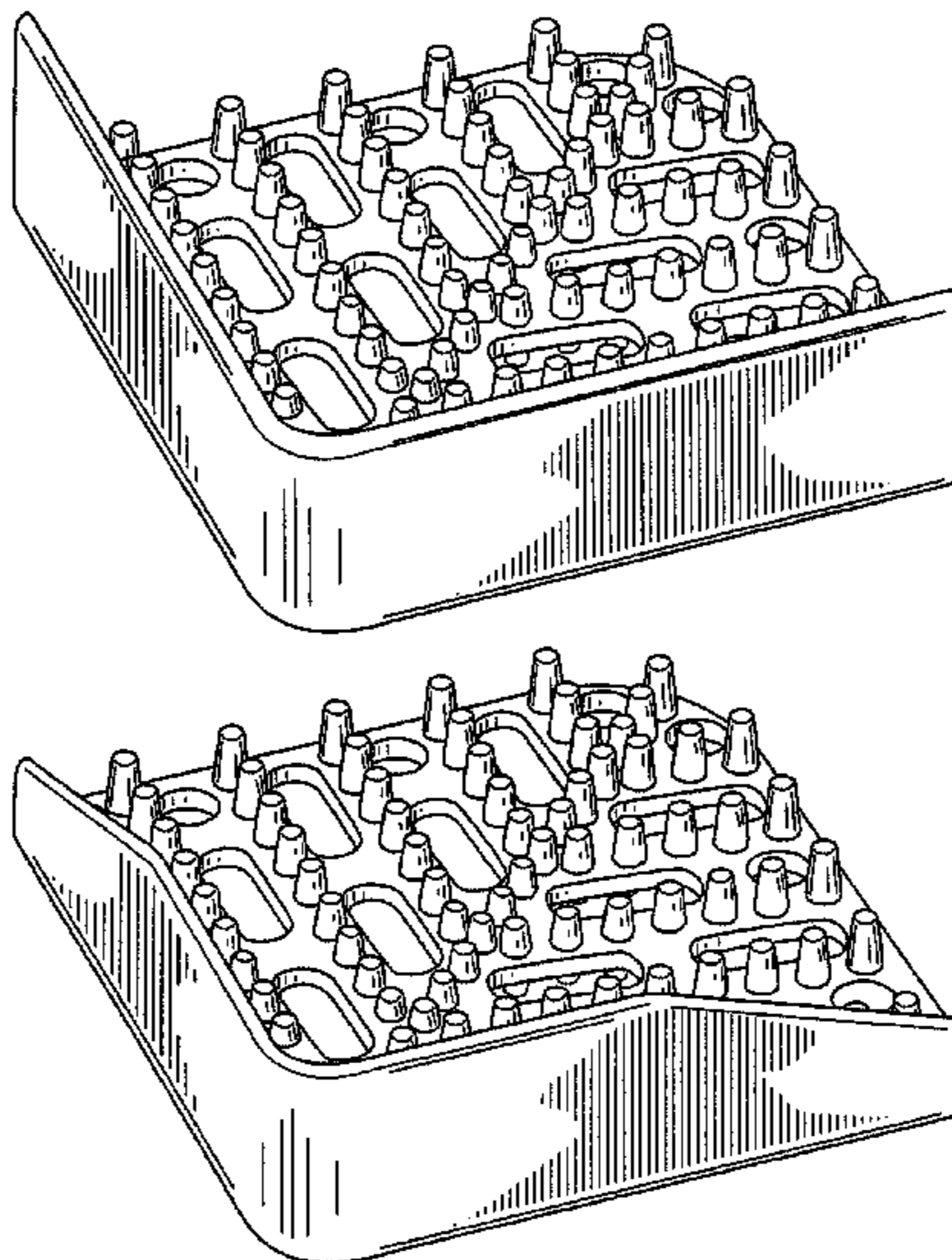

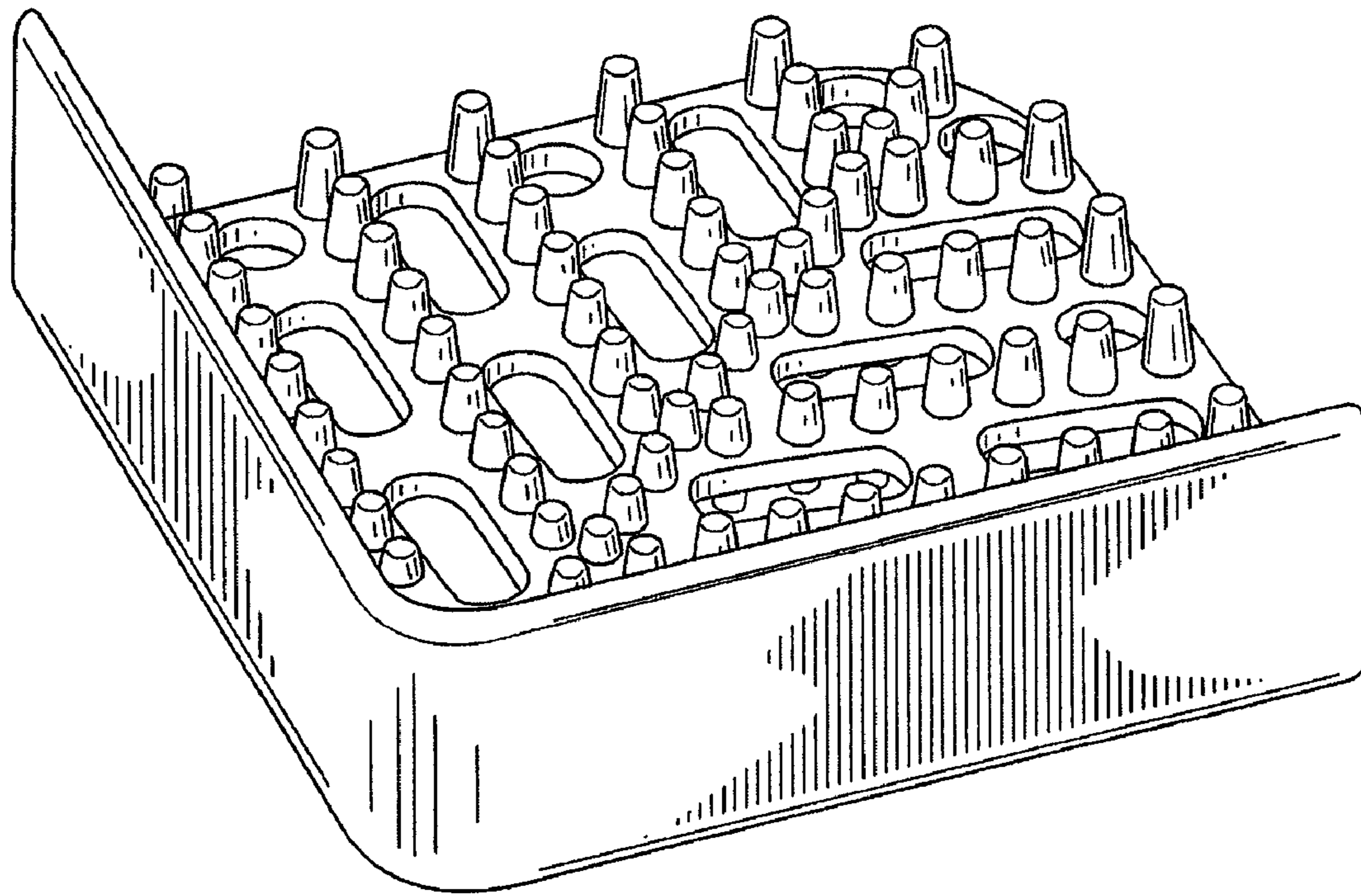

FIG. 1

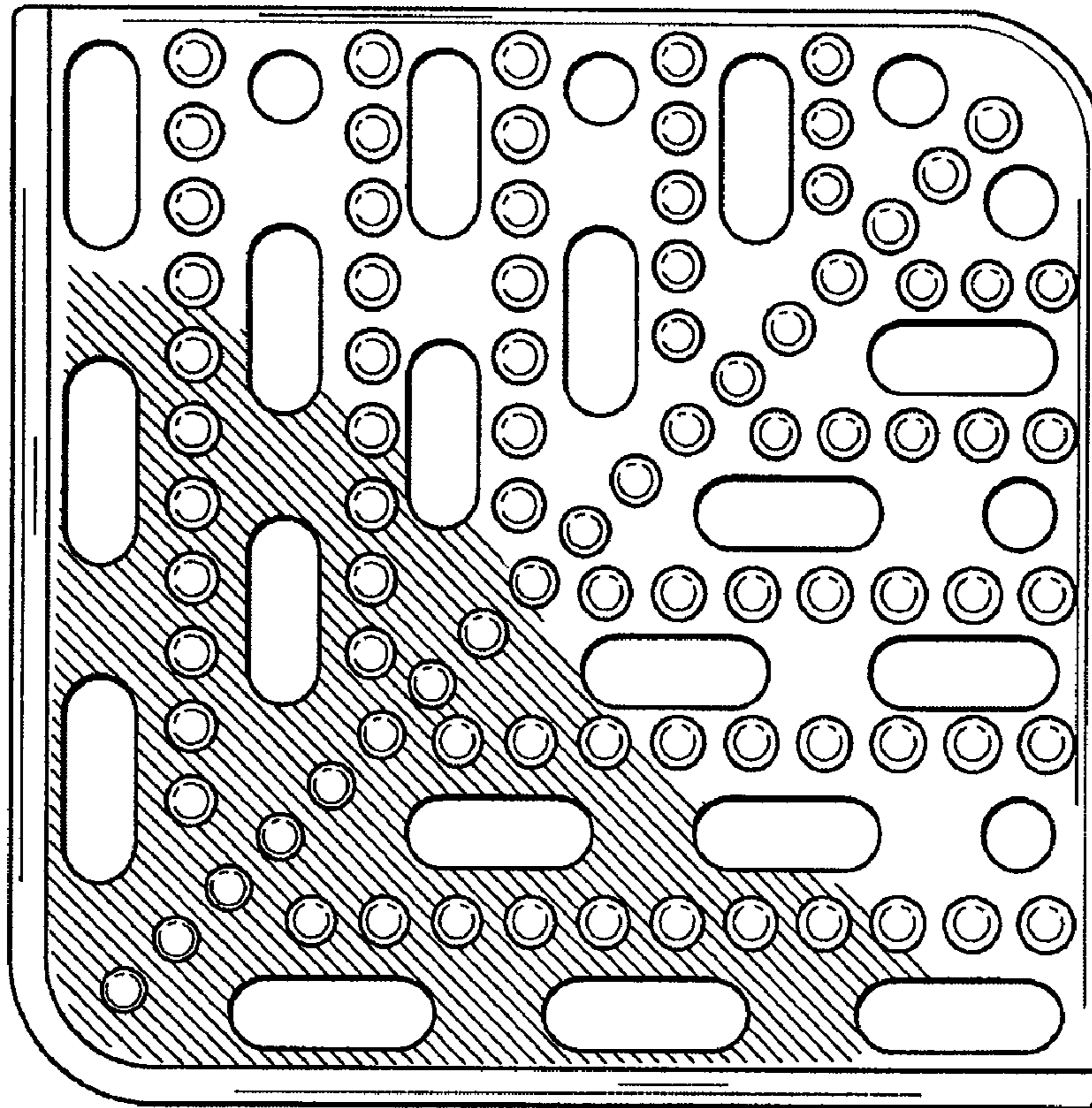

FIG. 2

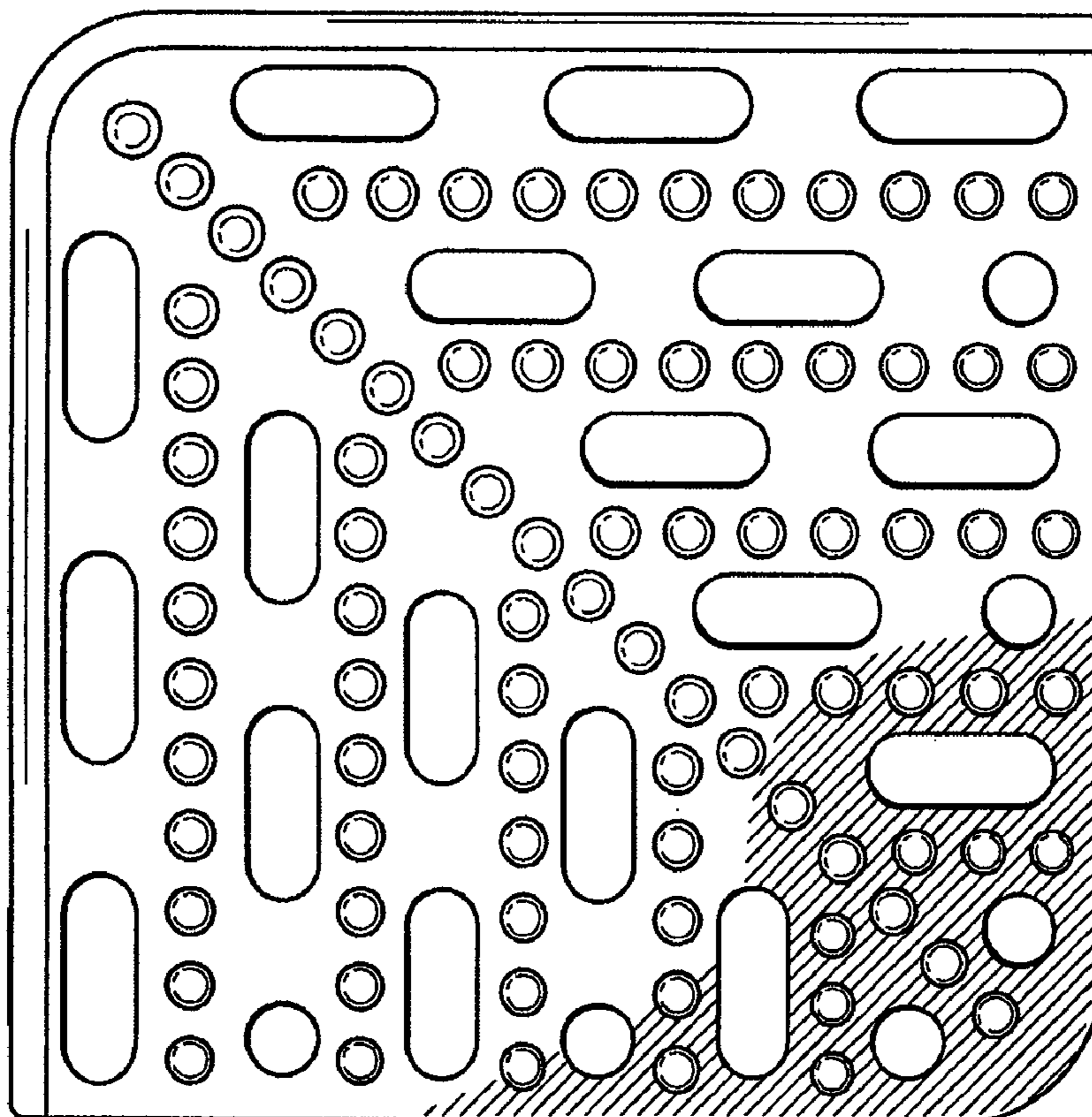

FIG. 3

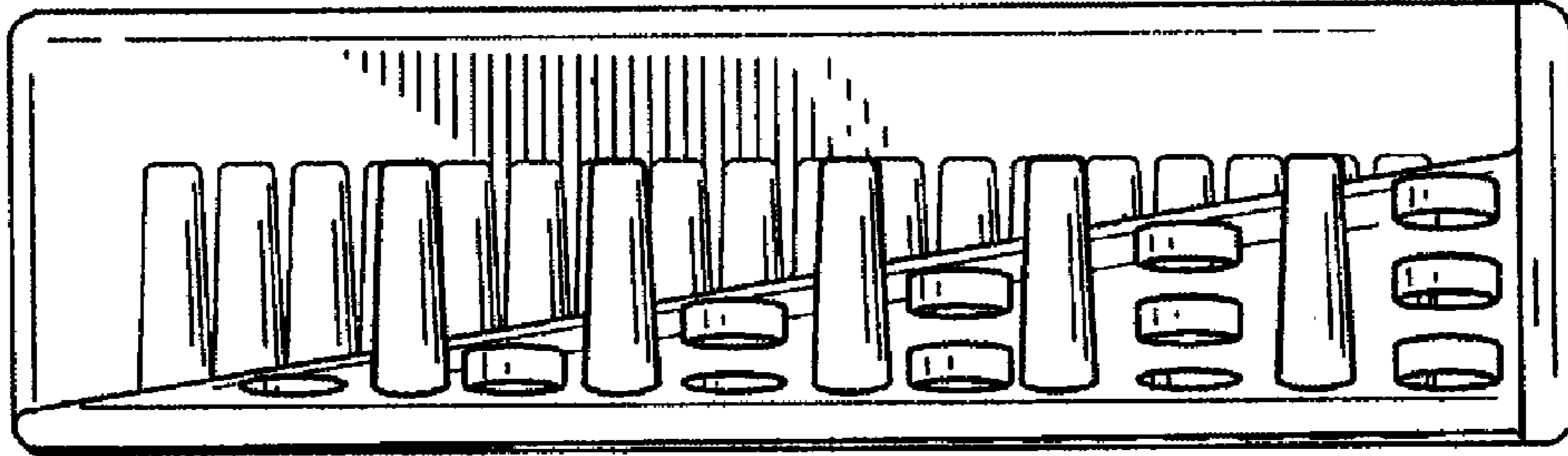

FIG. 4

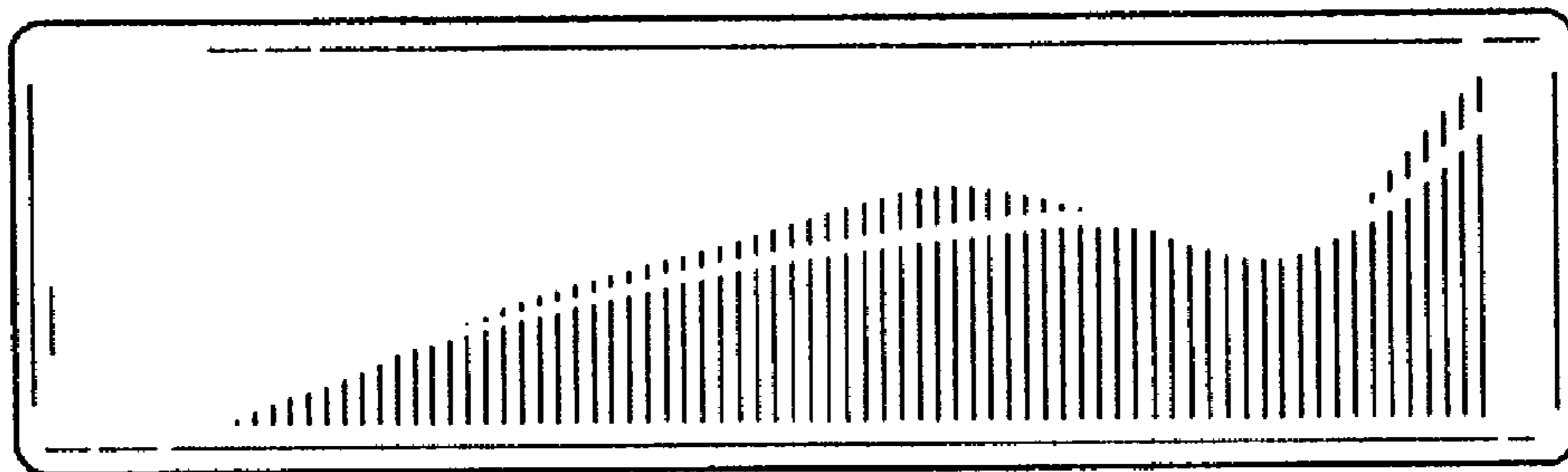

FIG. 5

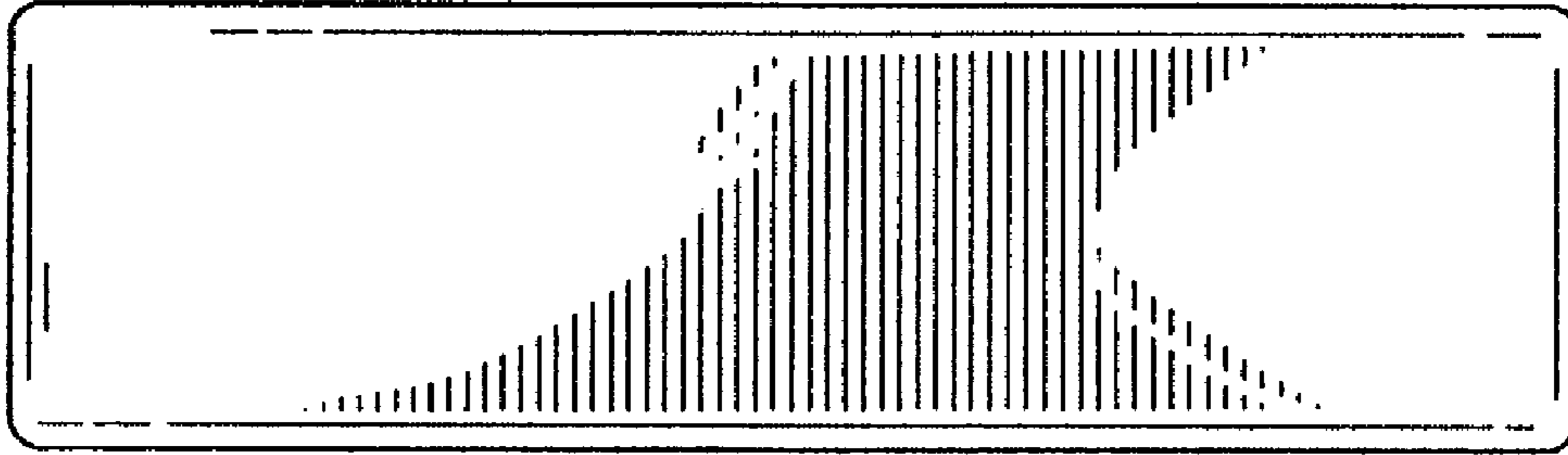

FIG. 6

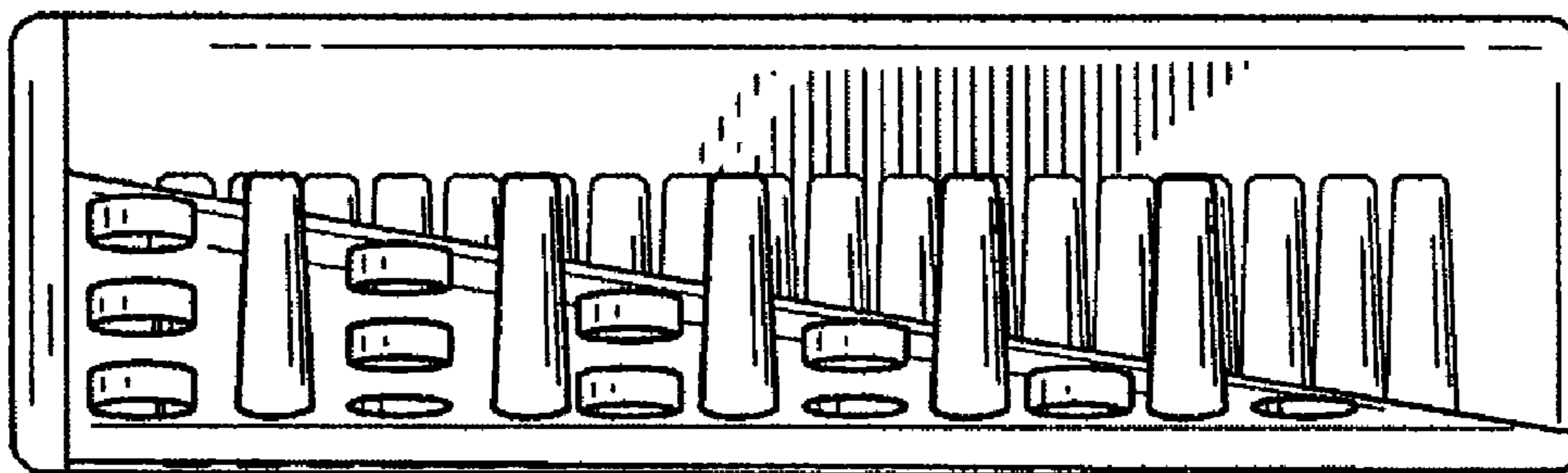

FIG. 7

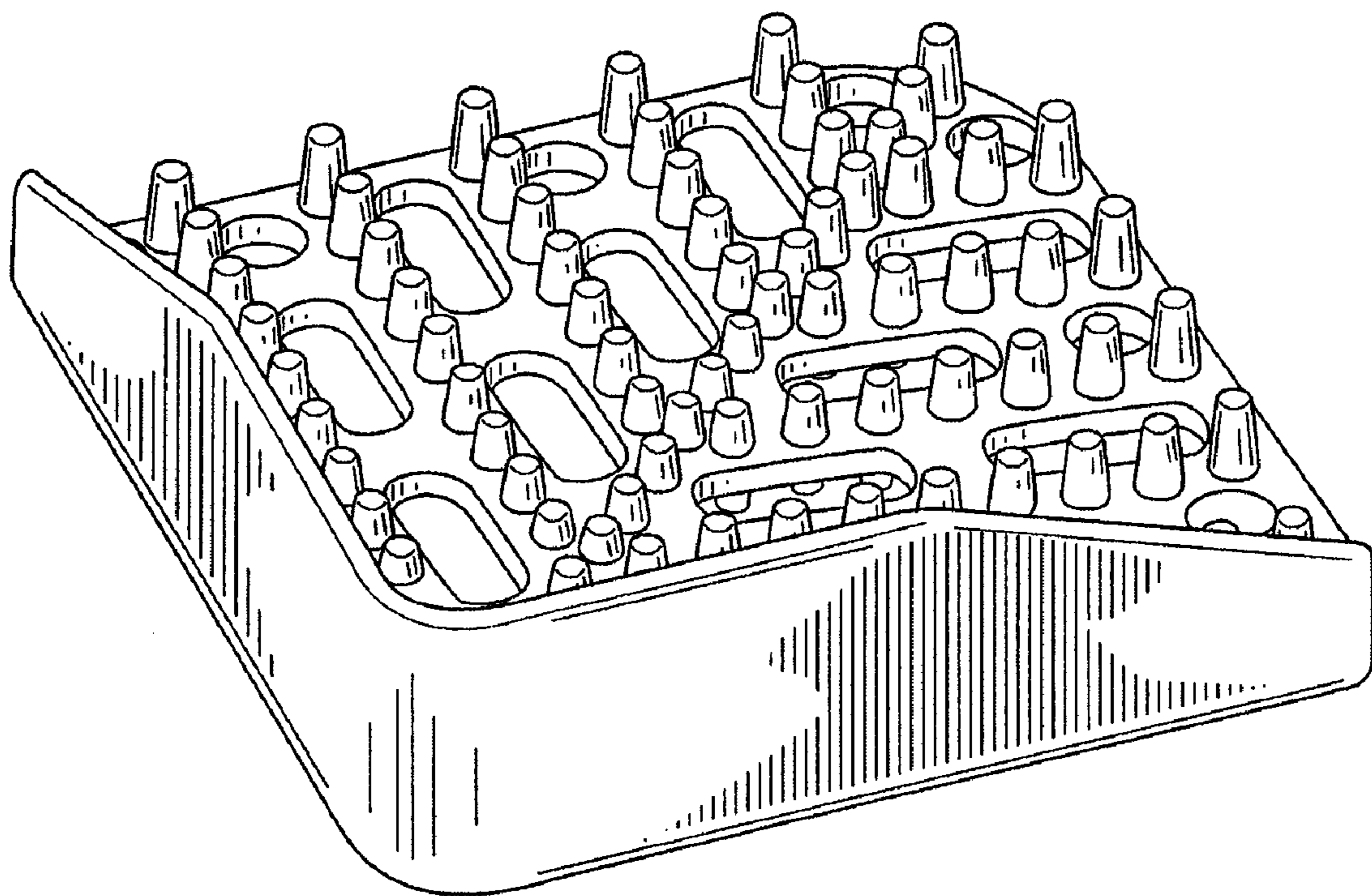

FIG. 8

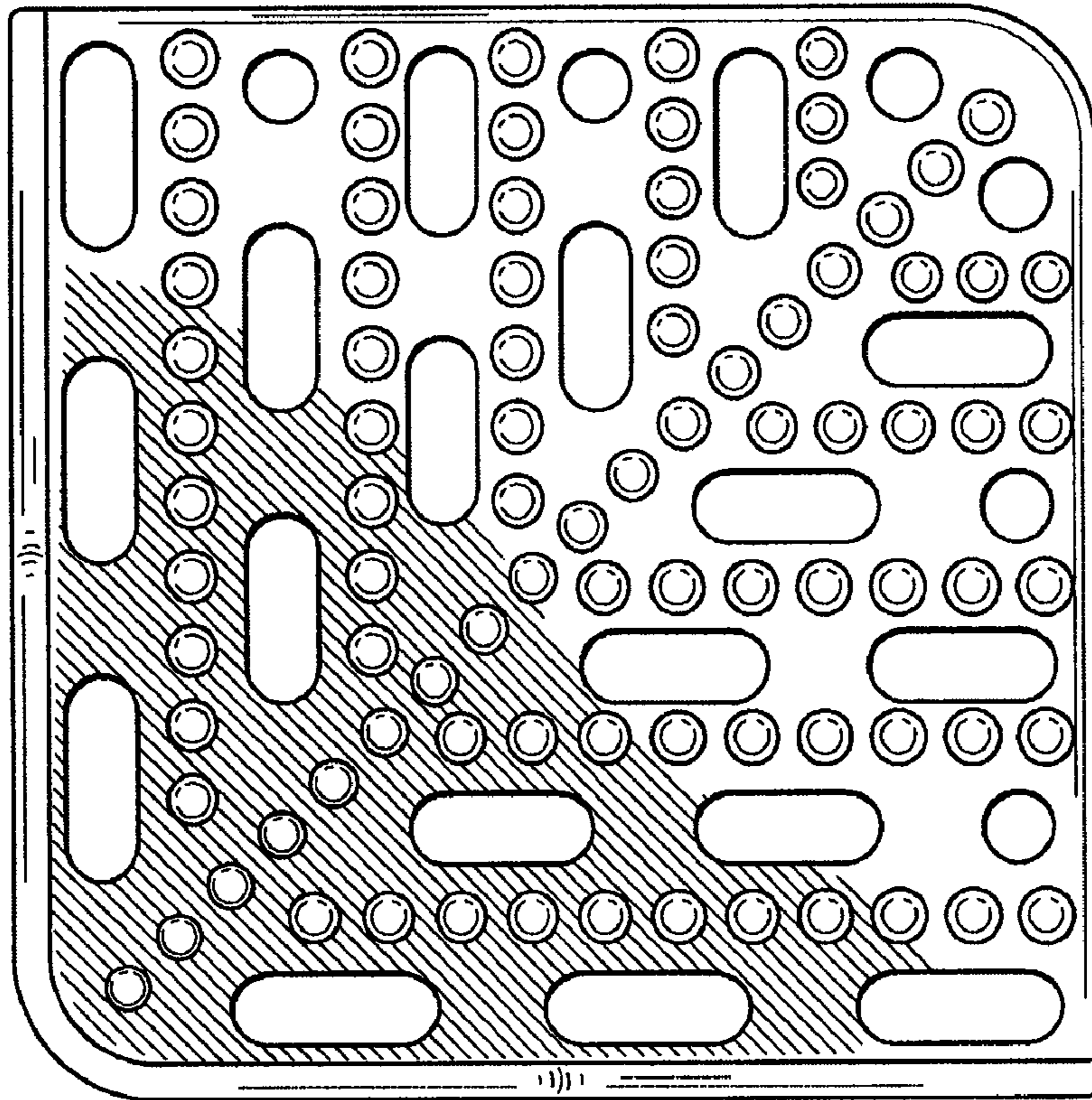

FIG. 9

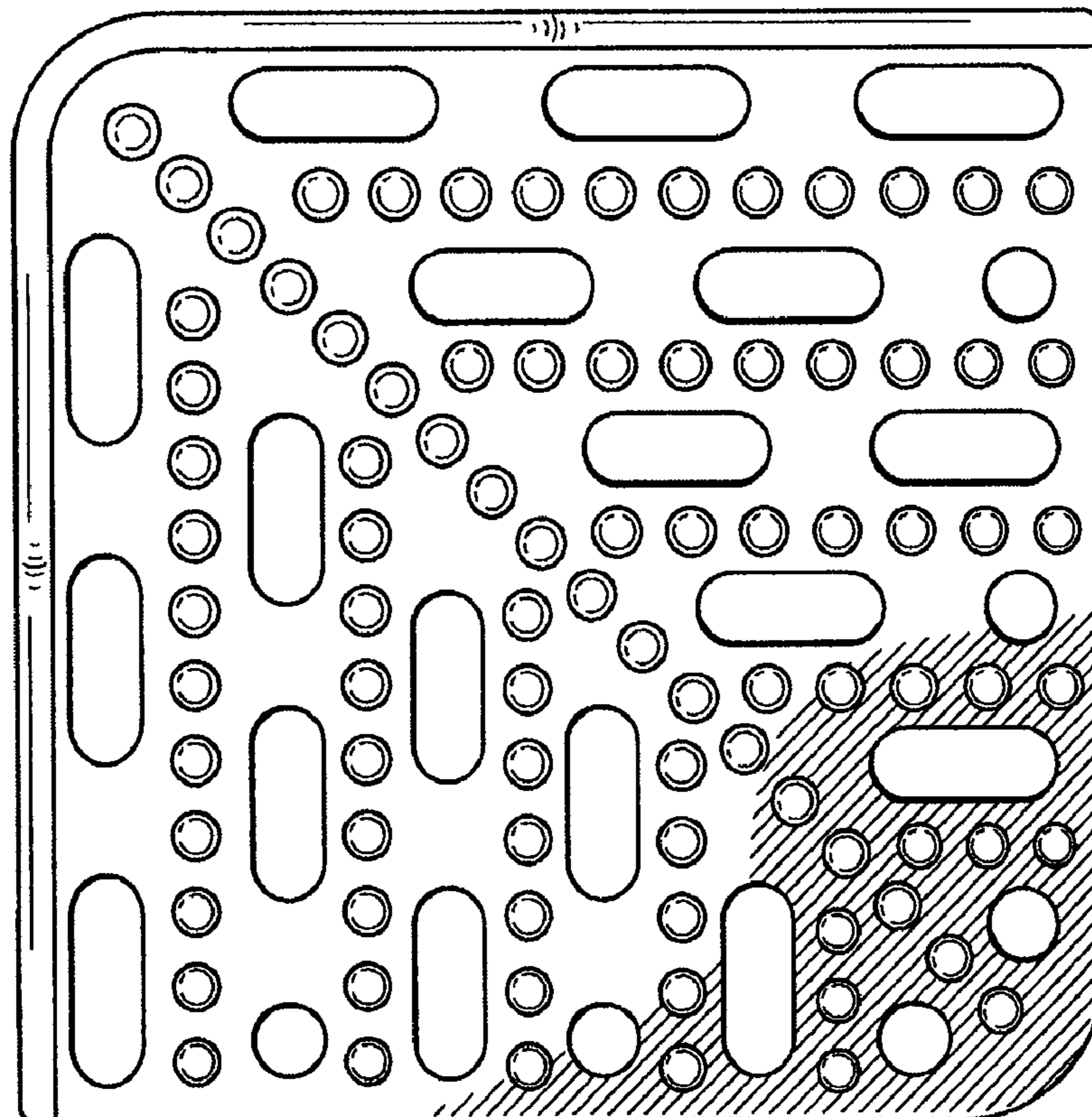

FIG. 10

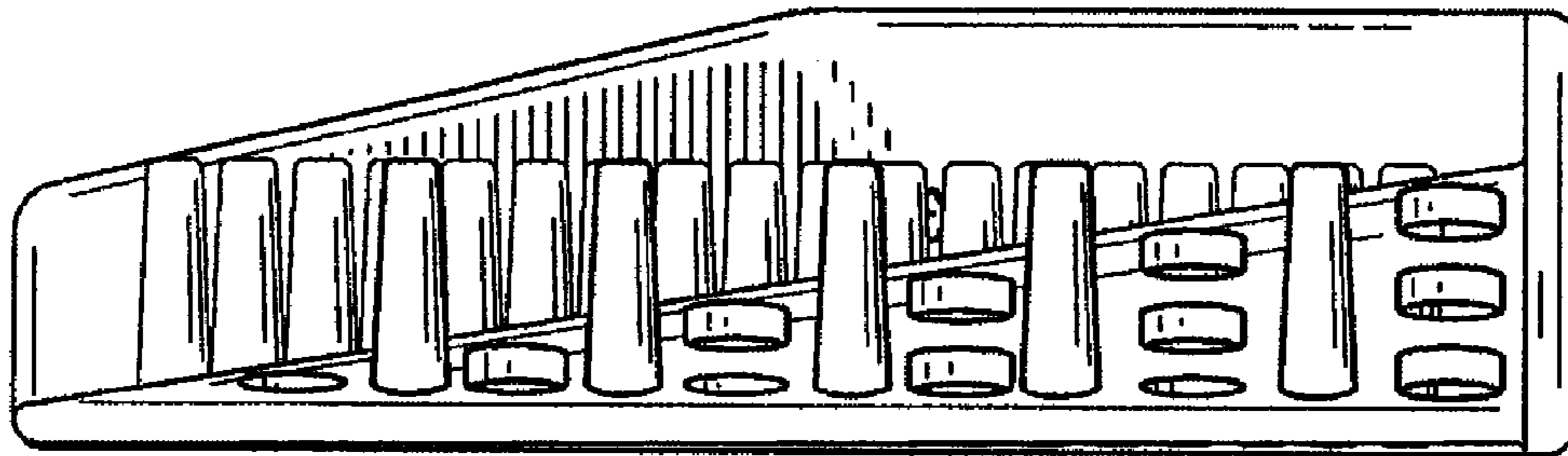

FIG. 11

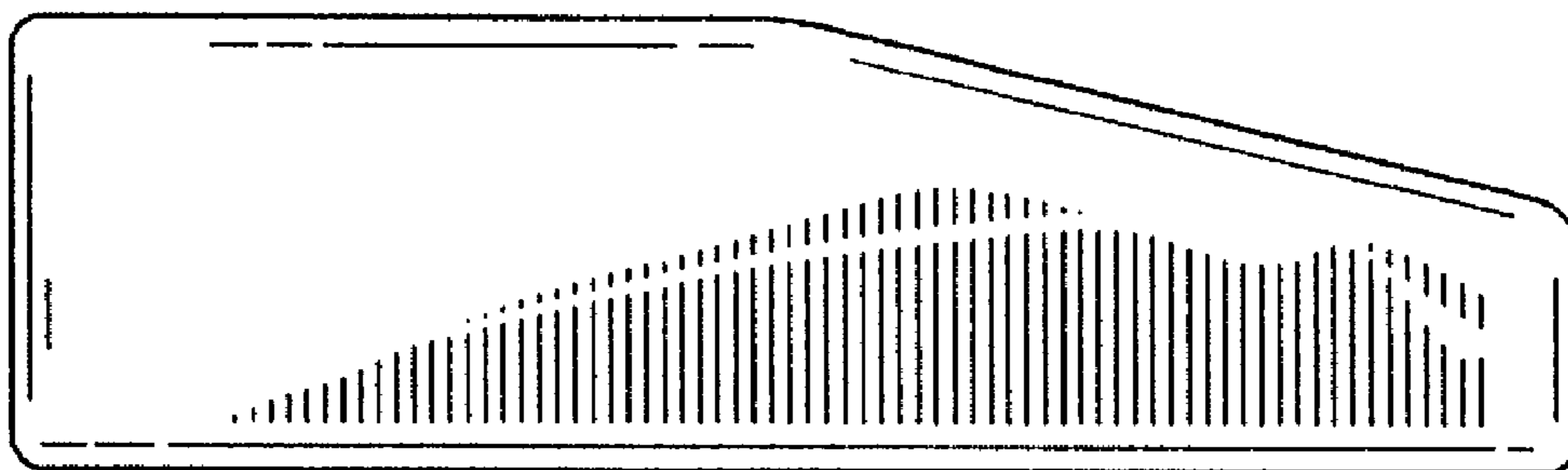

FIG. 12

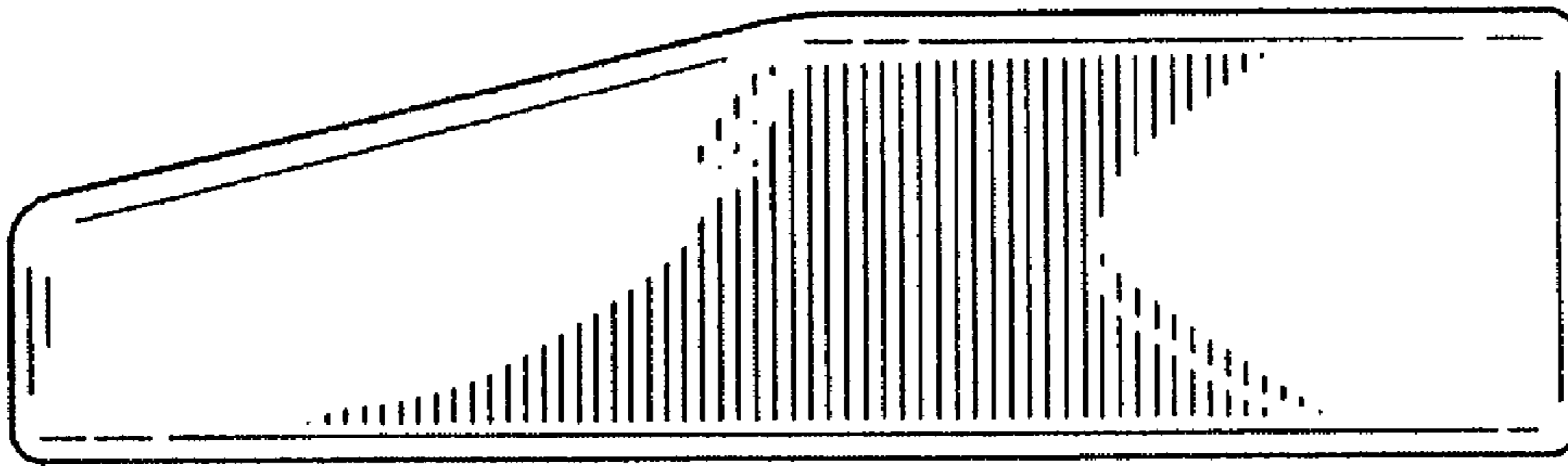

FIG. 13

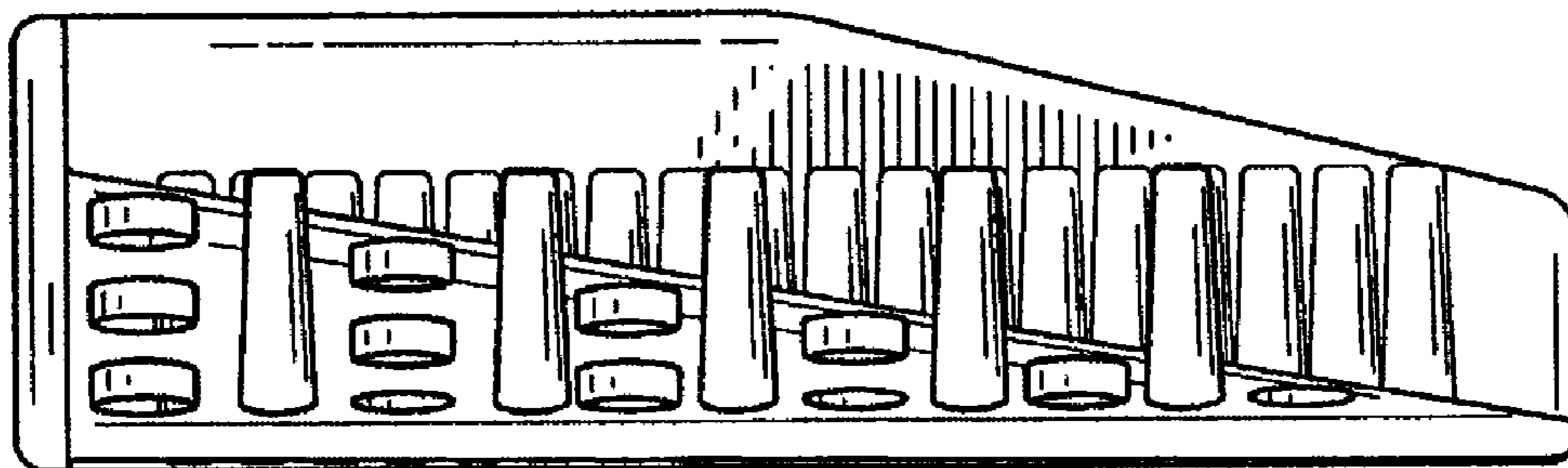

FIG. 14