

US00D560420S

(12) **United States Design Patent**
Roth

(10) **Patent No.:** **US D560,420 S**
(45) **Date of Patent:** **** Jan. 29, 2008**

(54) **FREESTANDING OUTDOOR KITCHEN
CART SYSTEM**

2006/0054156 A1* 3/2006 Zelek et al. 126/25 R
2006/0070614 A1* 4/2006 Spangrud 126/25 R

(75) Inventor: **John Roth**, Kolding (DK)
(73) Assignee: **Outstanding USA APS**, Kolding (DK)
(**) Term: **14 Years**
(21) Appl. No.: **29/272,754**
(22) Filed: **Feb. 16, 2007**
(30) **Foreign Application Priority Data**

Nov. 22, 2006 (EM) 000648928

(51) **LOC (8) Cl.** **07-02**

(52) **U.S. Cl.** **D7/334**

(58) **Field of Classification Search** D7/332,
D7/334, 402-404; D23/286; 4/624, 630-631,
4/643; 126/268, 276, 25 R, 41 R, 37 R,
126/40, 50; 99/445; 211/13.1; 248/127,
248/129
See application file for complete search history.

(56) **References Cited**

U.S. PATENT DOCUMENTS

1,854,777 A	4/1932	Bales	
D165,998 S	2/1952	Pollard	
D186,980 S	1/1960	Molitor	
D208,179 S	7/1967	Decatur	
D229,661 S *	12/1973	Lambertson	D7/334
D285,522 S *	9/1986	Basini	D7/334
D316,355 S *	4/1991	Stephen et al.	D7/334
5,862,540 A	1/1999	Chuan	
D411,782 S	7/1999	Husted	
6,213,483 B1	4/2001	Gaffney	
6,349,715 B1	2/2002	McBroom	
D460,656 S	7/2002	Caulder	
D466,367 S	12/2002	Johnson	
D471,761 S	3/2003	Choi et al.	
D472,756 S *	4/2003	Pai	D7/334
D476,188 S	6/2003	Wood	
D483,602 S	12/2003	Murray	
D496,820 S *	10/2004	Wilder	D7/334
6,814,383 B2	11/2004	Reed, III et al.	
D529,754 S *	10/2006	Chung	D7/334
D541,576 S *	5/2007	Lutz	D7/334

FOREIGN PATENT DOCUMENTS

EM	000010343	7/2003
EM	000022744	7/2003
EM	000021480	8/2003
EM	000057864	12/2003
EM	000077862	12/2003
EM	000069901	1/2004
EM	000225685	11/2004
EM	000383948	9/2005
EM	000384037	9/2005
EM	000398037	12/2005
EM	000431267	1/2006
EM	000500483	5/2006
EM	000546635	7/2006

OTHER PUBLICATIONS

American Metal Products Patio Carts, Model 2458-DR AMP.
Retrieved from Internet on May 7, 2007. <http://americanmp.com/patio_carts.htm>.*

(Continued)

Primary Examiner—Ruth McInroy
(74) *Attorney, Agent, or Firm*—Foley & Lardner LLP

(57) **CLAIM**

I claim the ornamental design for an freestanding outdoor kitchen cart system, as shown.

DESCRIPTION

FIG. 1 is a perspective view of a freestanding outdoor kitchen cart system showing my new design;
FIG. 2 is a front view thereof;
FIG. 3 is a back view thereof;
FIG. 4 is a right side view thereof;
FIG. 5 is a left side view thereof;
FIG. 6 is a top plan view thereof; and,
FIG. 7 is a bottom plan view thereof.

1 Claim, 4 Drawing Sheets

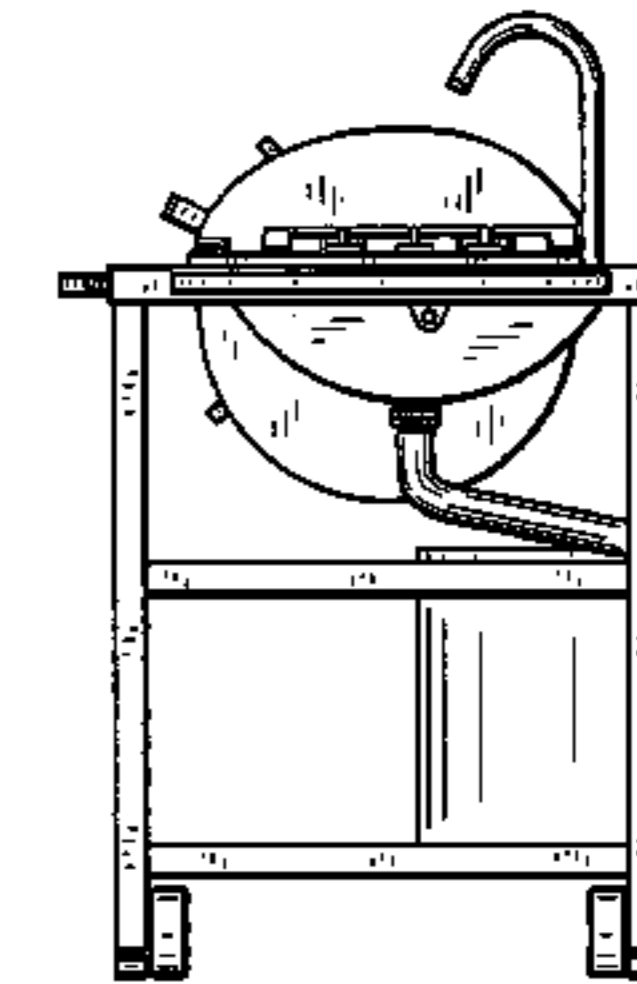
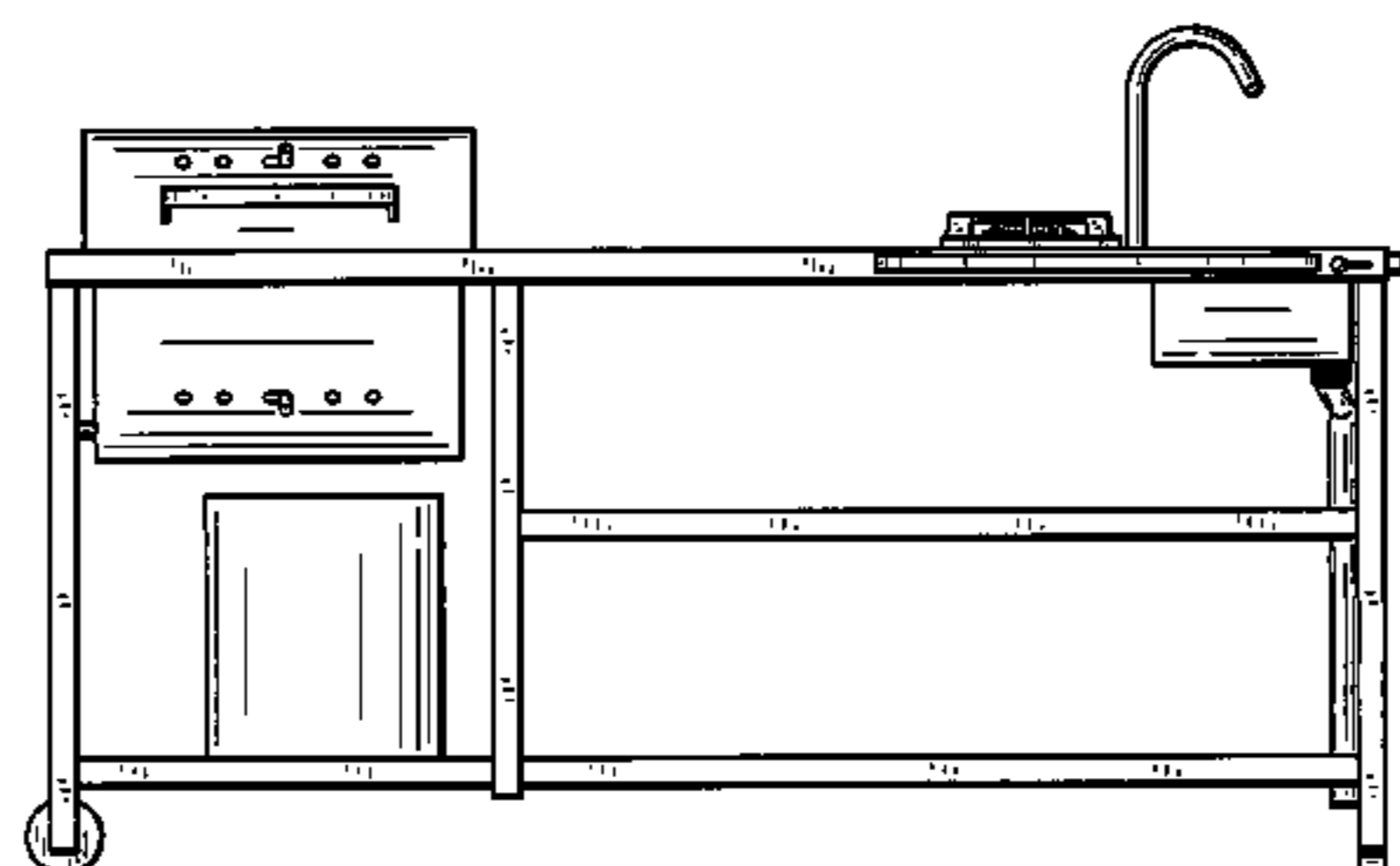
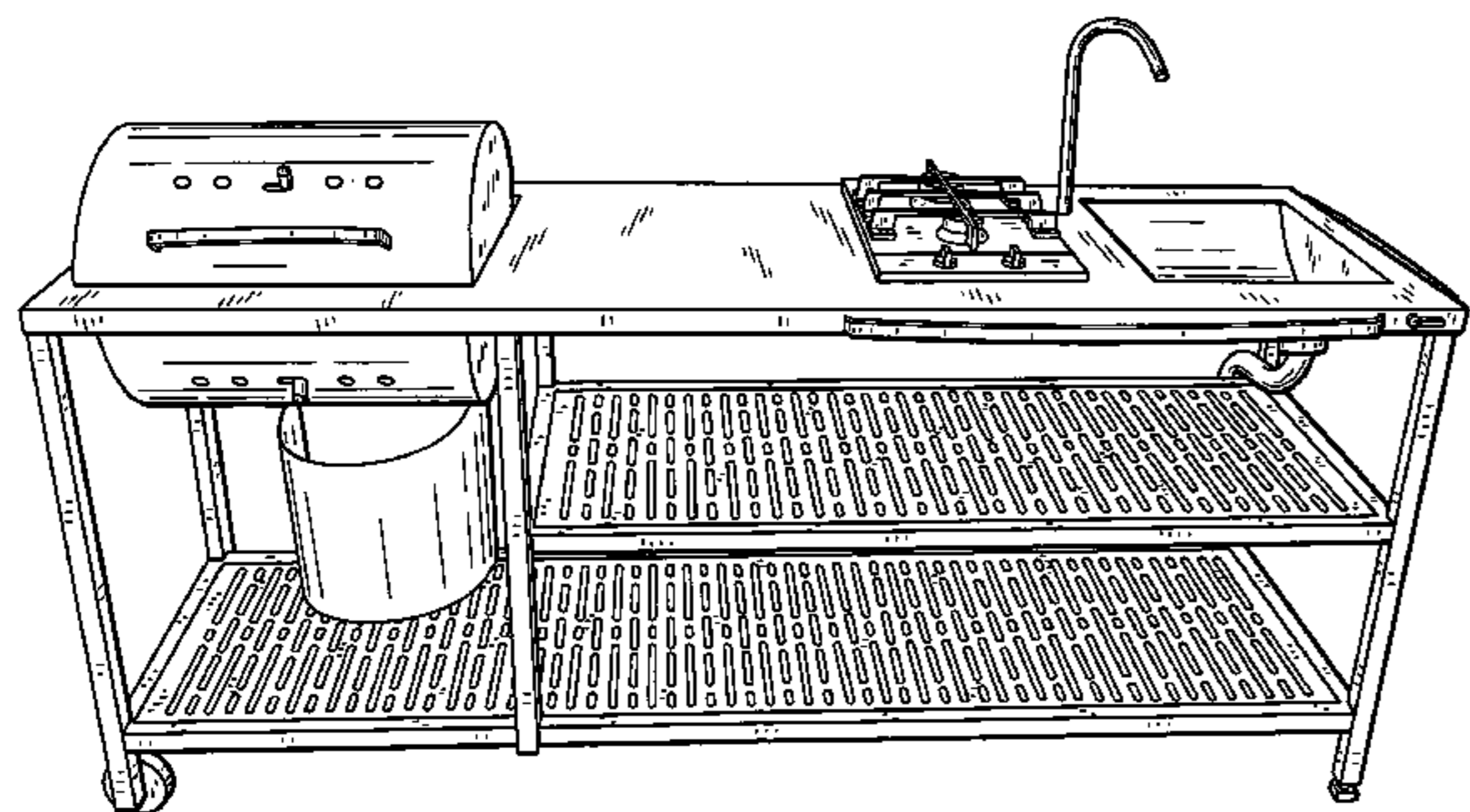

OTHER PUBLICATIONS

Oasis concepts 20x30x36 in. Delux Flip & Fold Folding Butcher Block Island, Natural. Retrieved from the Internet on May 7, 2007. <<http://www.olivergoodstuff.com/Cooking.com/Furnishings-Carts.html>>.*

Crown Verity Three Compartment Portable Sink Cart. Retrieved from the Internet on May 7, 2007. <www.abestkitchen.com/store/crown-verity.html>.*

Bar Sink with Faucet. Retrieved from the Internet on May 7, 2007. <www.grillsdirect.com/.../122+690+4294682883.cfm>.*

Pre-Examination Search Report dated Dec. 29, 2006 (2 pages).

Model K40 M/D/U-K60 from www.outdoorkitchen.com/denver/bbggrills/K40mdu.html ((Printed Feb. 15, 2007).

All Grills Models Print-Out from www.allgrills.com (Printed Feb. 15, 2007).

Grill Islands Models Print-Out from www.outdoorkitchens.com/grill_islands.htm (Printed Feb. 15, 2007).

Dacor Grill Islands Models Print-Out from www.uokdesigns.com/dacor.php (Printed Feb. 15, 2007).

* cited by examiner

FIG. 1

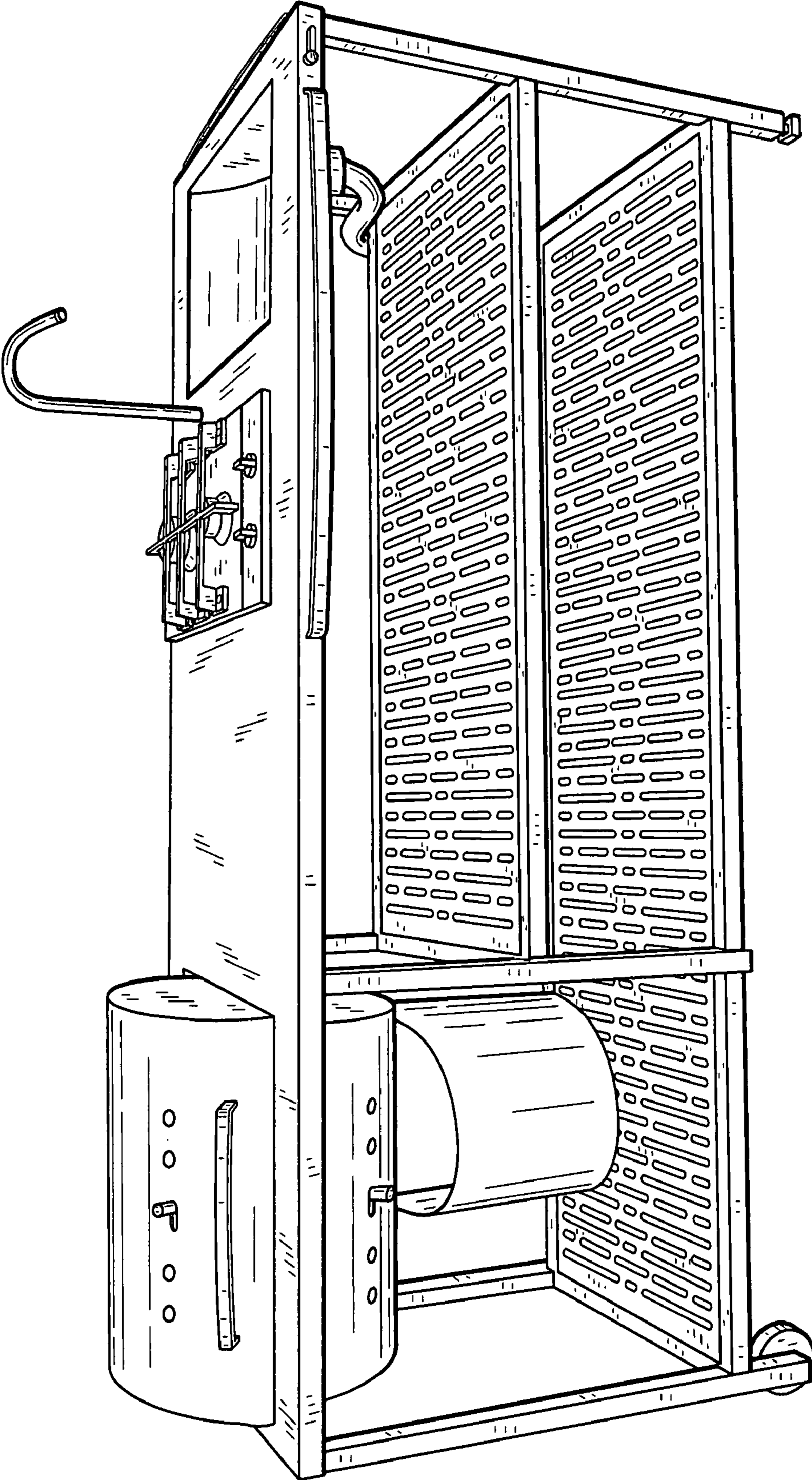

FIG. 2

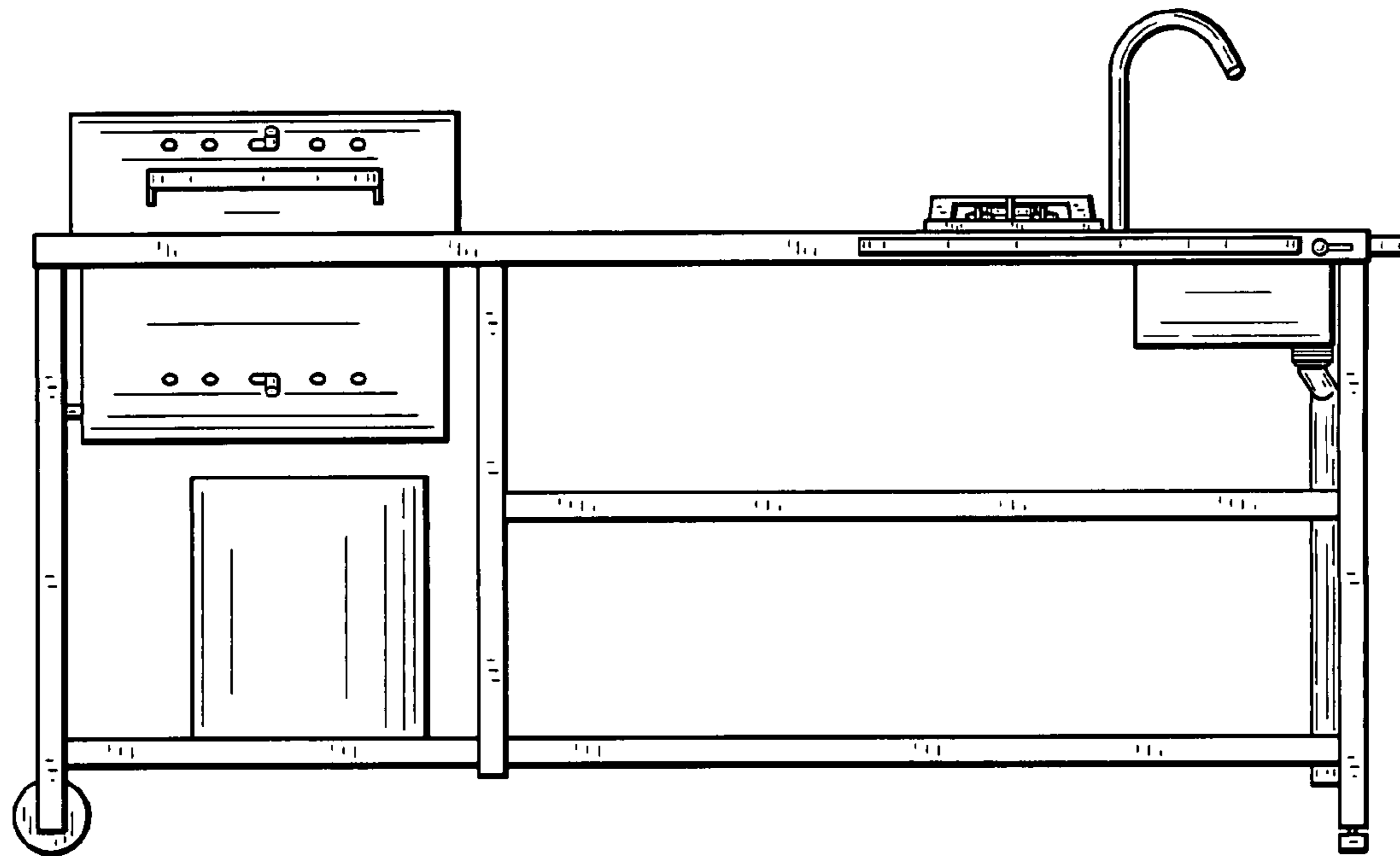

FIG. 3

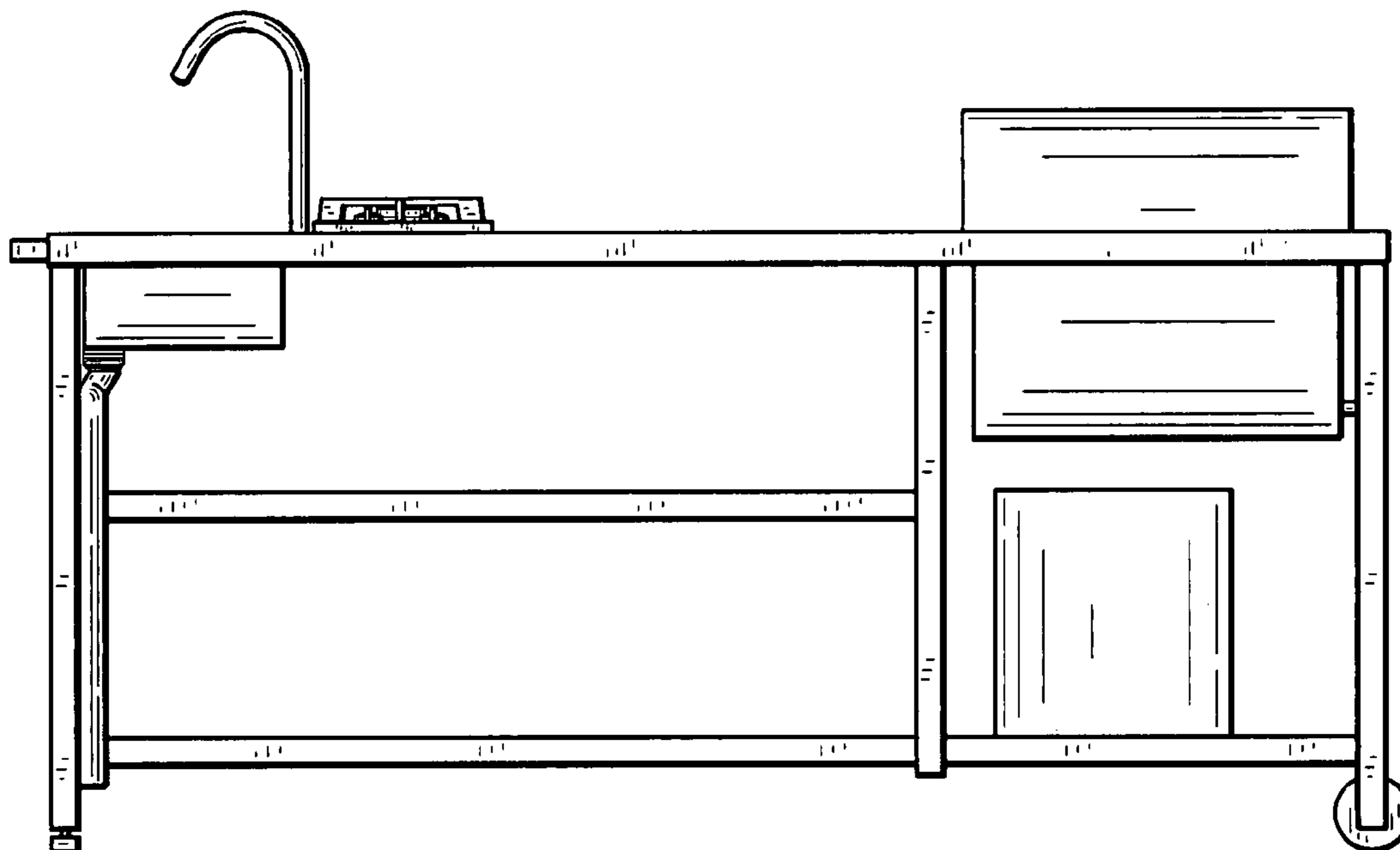

FIG. 4

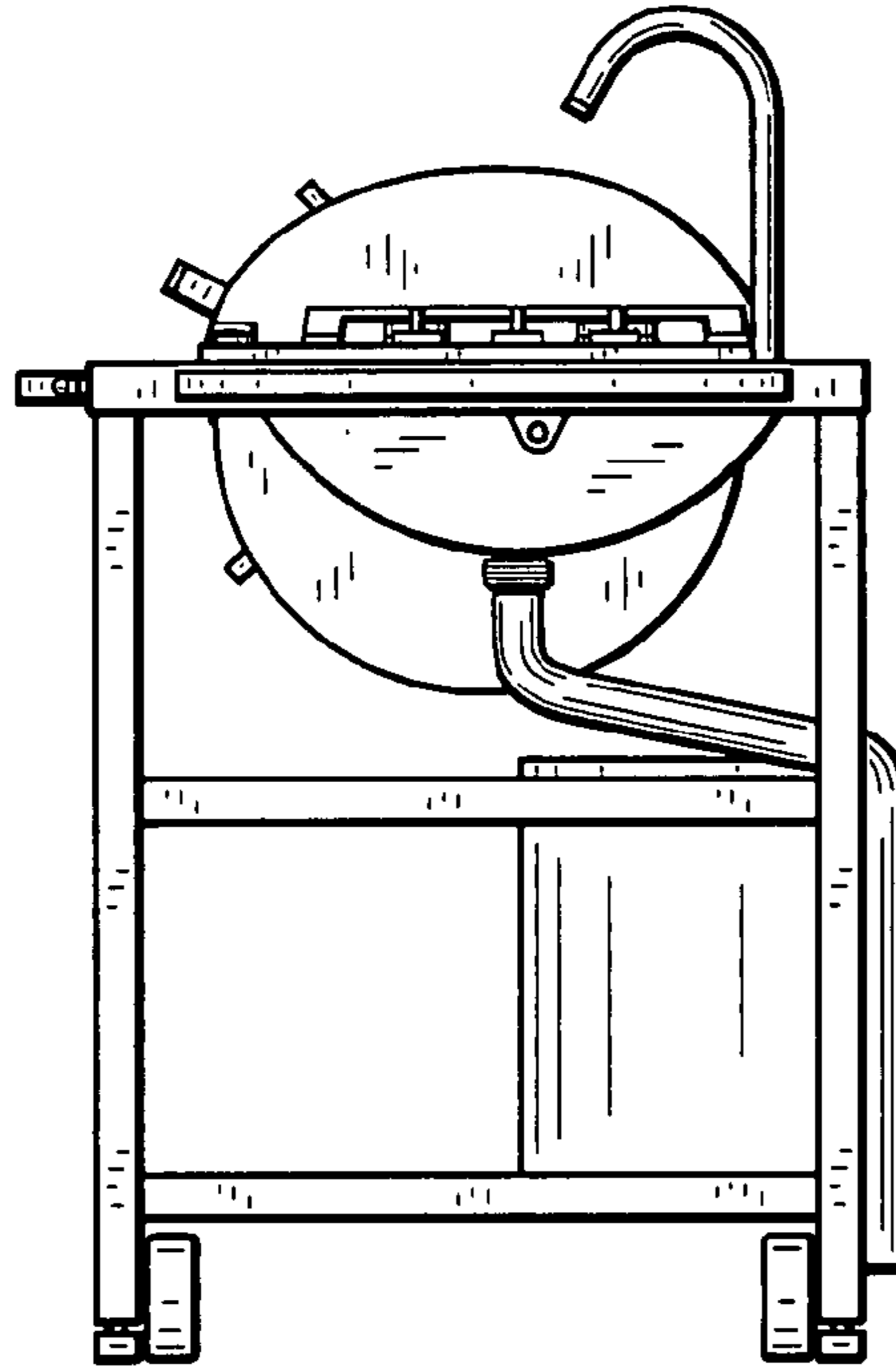

FIG. 5

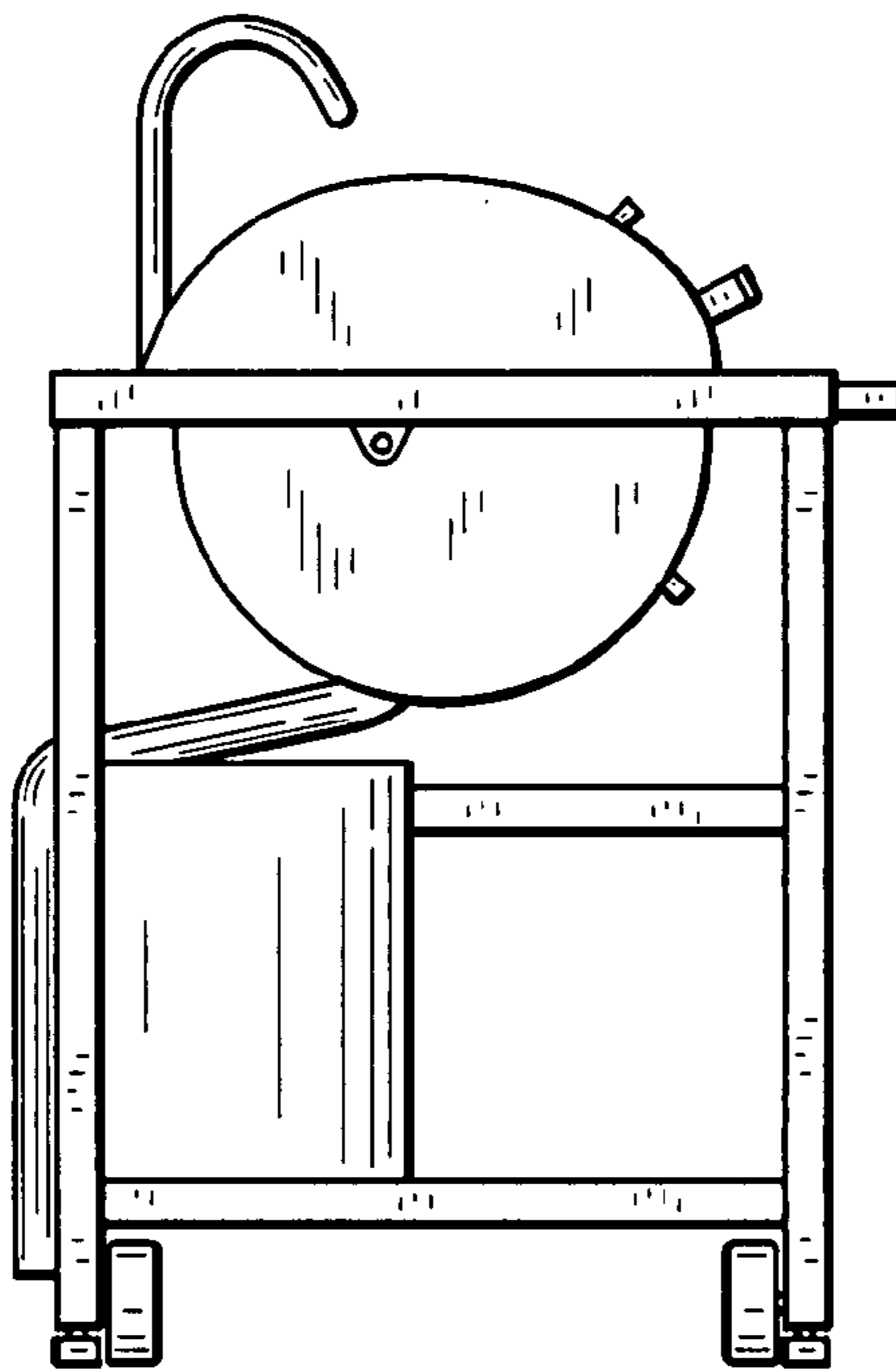

FIG. 6

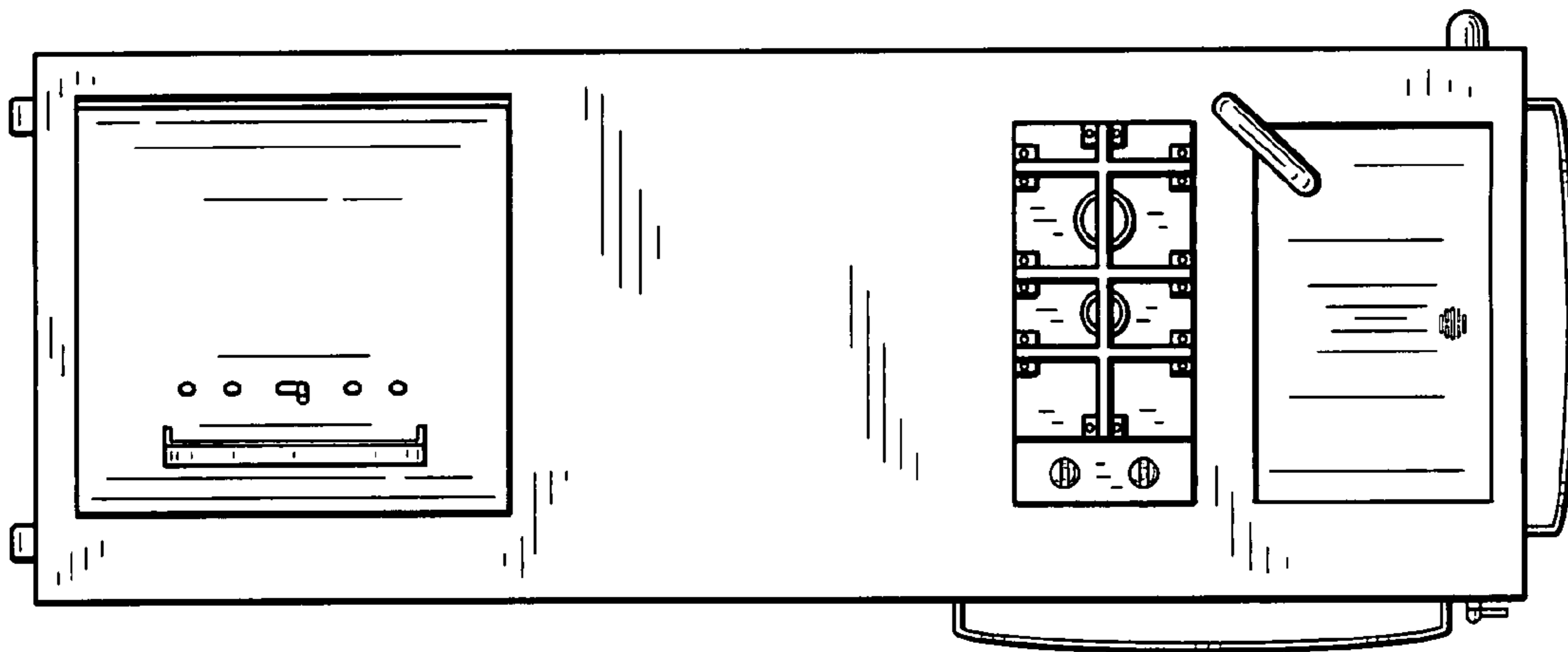

FIG. 7

