



US00D560319S

(12) **United States Design Patent**
Hirunuma et al.

(10) **Patent No.: US D560,319 S**
(45) **Date of Patent: ** Jan. 22, 2008**

(54) **CLEANER**
(75) Inventors: **Ken Hirunuma**, Tokyo (JP); **Takeo Suzuki**, Tokyo (JP)
(73) Assignee: **PENTAX Corporation**, Tokyo (JP)
(**) Term: **14 Years**
(21) Appl. No.: **29/285,009**
(22) Filed: **Mar. 20, 2007**

JP 2003-220014 A 8/2003
JP 2005-334525 A 12/2005
JP 2006-000134 A 1/2006
JP 2006-6690 A 1/2006

(30) **Foreign Application Priority Data**
Sep. 21, 2006 (JP) 2006-025253
(51) **LOC (8) Cl.** **04-01**
(52) **U.S. Cl.** **D32/40**
(58) **Field of Classification Search** D32/40-42,
D32/35, 45, 50-51; 15/208, 209.1, 210.1,
15/211, 220.1, 244.1-244.2, 244.4
See application file for complete search history.

(56) **References Cited**
U.S. PATENT DOCUMENTS
D306,924 S * 3/1990 Shapton D32/45
5,799,357 A * 9/1998 Taylor 15/244.1
5,855,214 A * 1/1999 Heneghan 132/320
D410,110 S * 5/1999 Roland D28/7
D423,743 S * 4/2000 Dawson et al. D32/40
6,574,825 B1 * 6/2003 Boldy 15/244.4
D511,872 S * 11/2005 Vitantonio et al. D32/40
6,973,695 B1 * 12/2005 Nesler 15/220.1
D513,444 S * 1/2006 Vitantonio et al. D32/40

FOREIGN PATENT DOCUMENTS
JP 6-63183 U 9/1994

OTHER PUBLICATIONS

U.S. Appl. No. 29/285,008, filed Mar. 20, 2007, Yuji Terao.
U.S. Appl. No. 29/285,022, filed Mar. 20, 2007, Yuji Terao.
U.S. Appl. No. 29/285,021, filed Mar. 20, 2007, Yuji Terao.
U.S. Appl. No. 29/285,023, filed Mar. 20, 2007, Takeo Suzuki.
U.S. Appl. No. 29/285,010, filed Mar. 20, 2007, Yuji Terao.

* cited by examiner

Primary Examiner—Pamela J. Burgess
(74) *Attorney, Agent, or Firm*—Sughrue Mion, PLLC

(57) **CLAIM**

The ornamental design for a cleaner, as shown and described.

DESCRIPTION

FIG. 1 is a perspective view of the top, front and left side of a cleaner showing our new design;
FIG. 2 is a front elevational view thereof;
FIG. 3 is a top plan view thereof, with the bottom view being a mirror image;
FIG. 4 is a left side elevational view thereof;
FIG. 5 is a right side elevational view thereof; and,
FIG. 6 is a rear elevational view thereof.

1 Claim, 2 Drawing Sheets

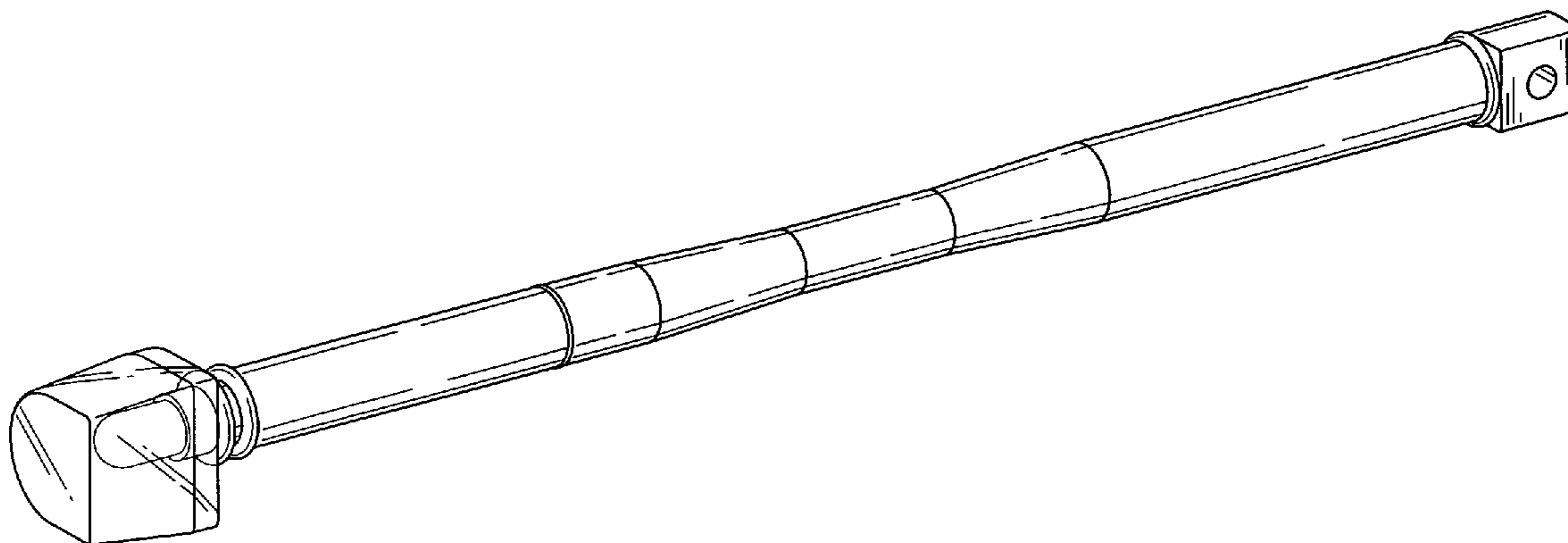

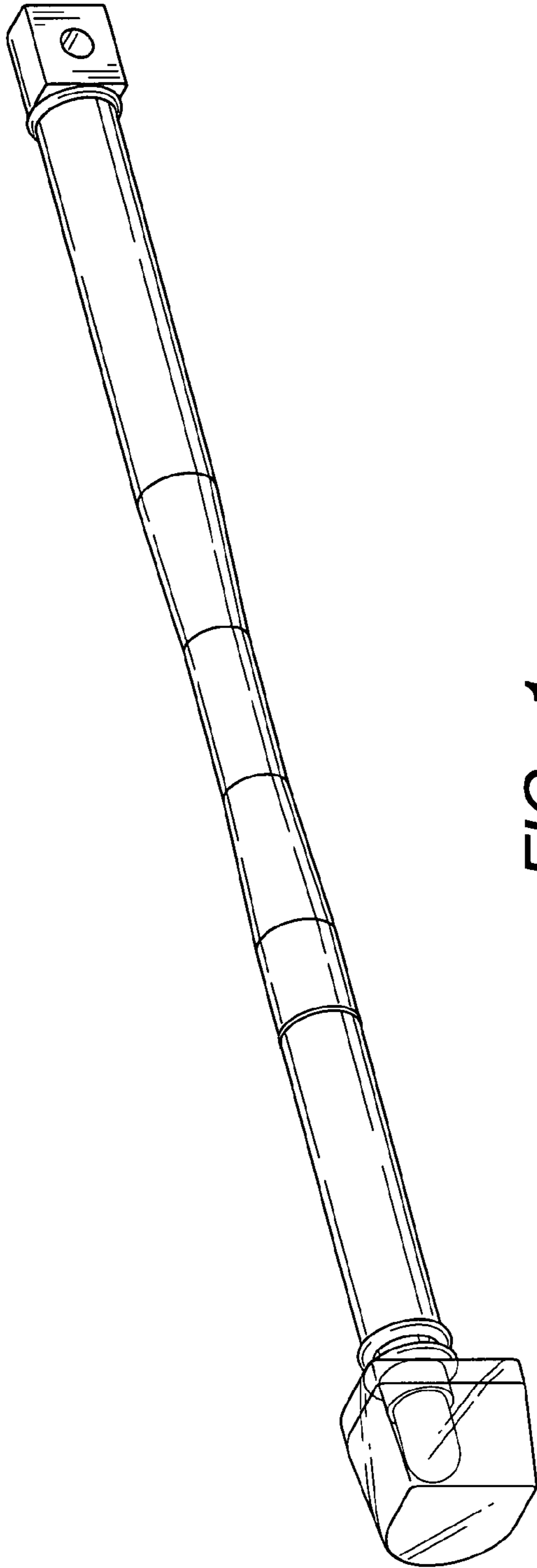

FIG. 1

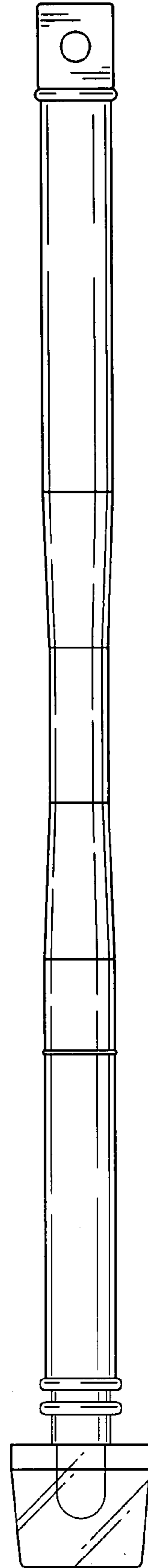

FIG. 2

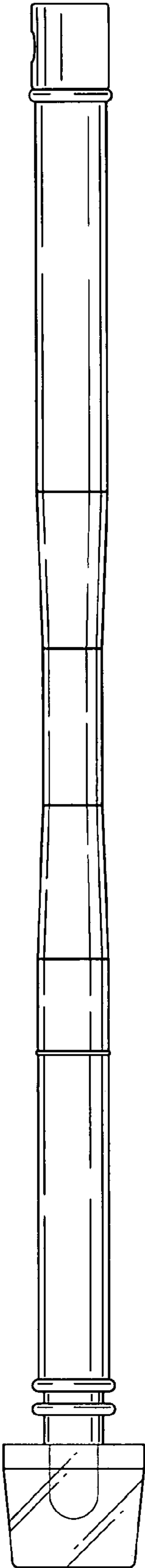

FIG. 3

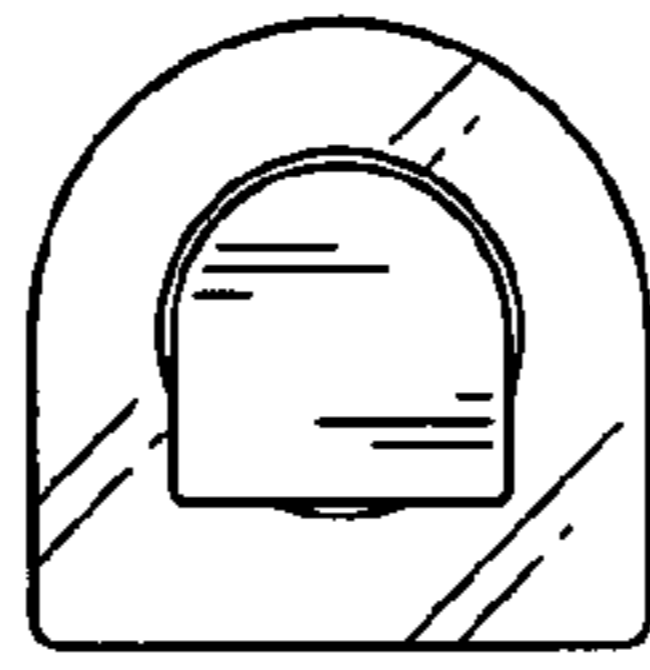

FIG. 5

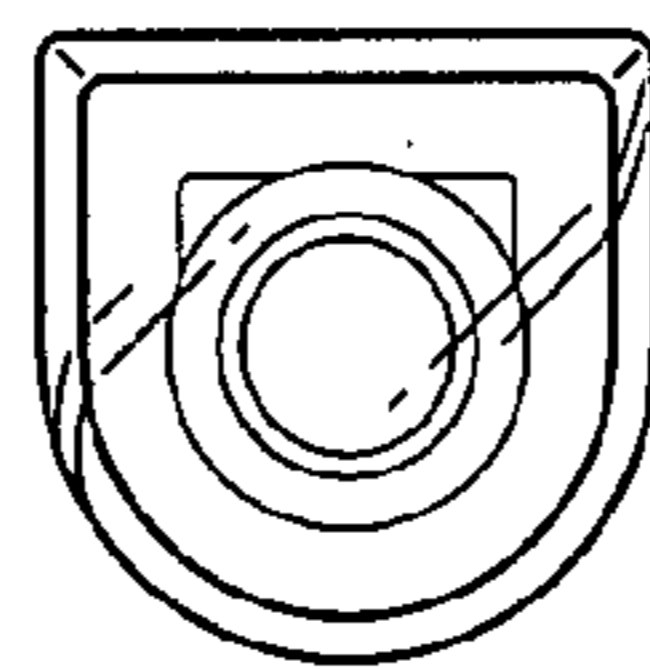

FIG. 4

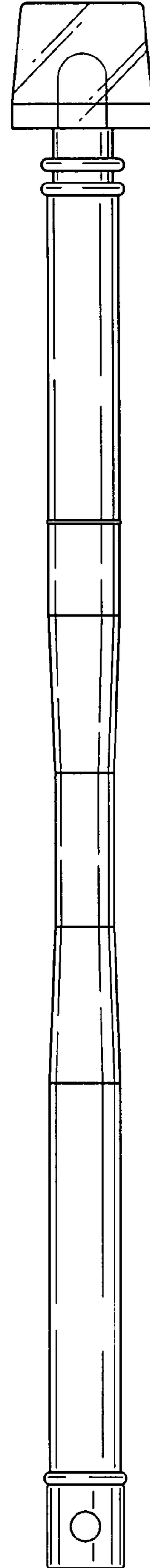

FIG. 6