



US00D560312S

(12) **United States Design Patent**
Washington

(10) **Patent No.:** **US D560,312 S**
(45) **Date of Patent:** **** Jan. 22, 2008**

(54) **COSMETIC ORGANIZER**

(76) Inventor: **Jill Washington**, 722 Boulevard East,
Weehawken, NJ (US) 07086

(**) Term: **14 Years**

(21) Appl. No.: **29/277,441**

(22) Filed: **Feb. 26, 2007**

(51) **LOC (8) Cl.** **28-03**

(52) **U.S. Cl.** **D28/73; D28/76**

(58) **Field of Classification Search** 132/286-288,
132/293-307, 312-318; D28/73, 76-84;
206/581, 823

See application file for complete search history.

(56) **References Cited**

U.S. PATENT DOCUMENTS

4,635,657	A *	1/1987	Stanford	132/286
4,815,483	A *	3/1989	DuGrenier et al.	132/295
5,025,817	A *	6/1991	Wen	132/296
D471,321	S *	3/2003	Lai	D28/82
D533,310	S *	12/2006	Kuo	D28/76
2006/0231116	A1 *	10/2006	Kaiser et al.	132/295

* cited by examiner

Primary Examiner—Jennifer Rivard

(74) *Attorney, Agent, or Firm*—Fish & Richardson P.C.

(57) **CLAIM**

The ornamental design for a cosmetic organizer, as shown and described.

DESCRIPTION

FIG. 1 is a front perspective closed view of the cosmetic organizer.

FIG. 2 is a front closed view of the cosmetic organizer.

FIG. 3 is a back closed view of the cosmetic organizer.

FIG. 4 is a left closed view of the cosmetic organizer.

FIG. 5 is a right closed view of the cosmetic organizer.

FIG. 6 is a top closed view of the cosmetic organizer.

FIG. 7 is a bottom closed view of the cosmetic organizer.

FIG. 8 is a front perspective open view of the cosmetic organizer.

FIG. 9 is a front open view of the cosmetic organizer.

FIG. 10 is a back open view of the cosmetic organizer.

FIG. 11 is a left open view of the cosmetic organizer.

FIG. 12 is a right open view of the cosmetic organizer.

FIG. 13 is a top open view of the cosmetic organizer; and,

FIG. 14 is a bottom open view of the cosmetic organizer.

The broken lines immediately adjacent the shaded areas represent the bounds of the claim and all other broken lines are for illustrative purposes only. None of the broken lines form a part of the claimed design.

1 Claim, 13 Drawing Sheets

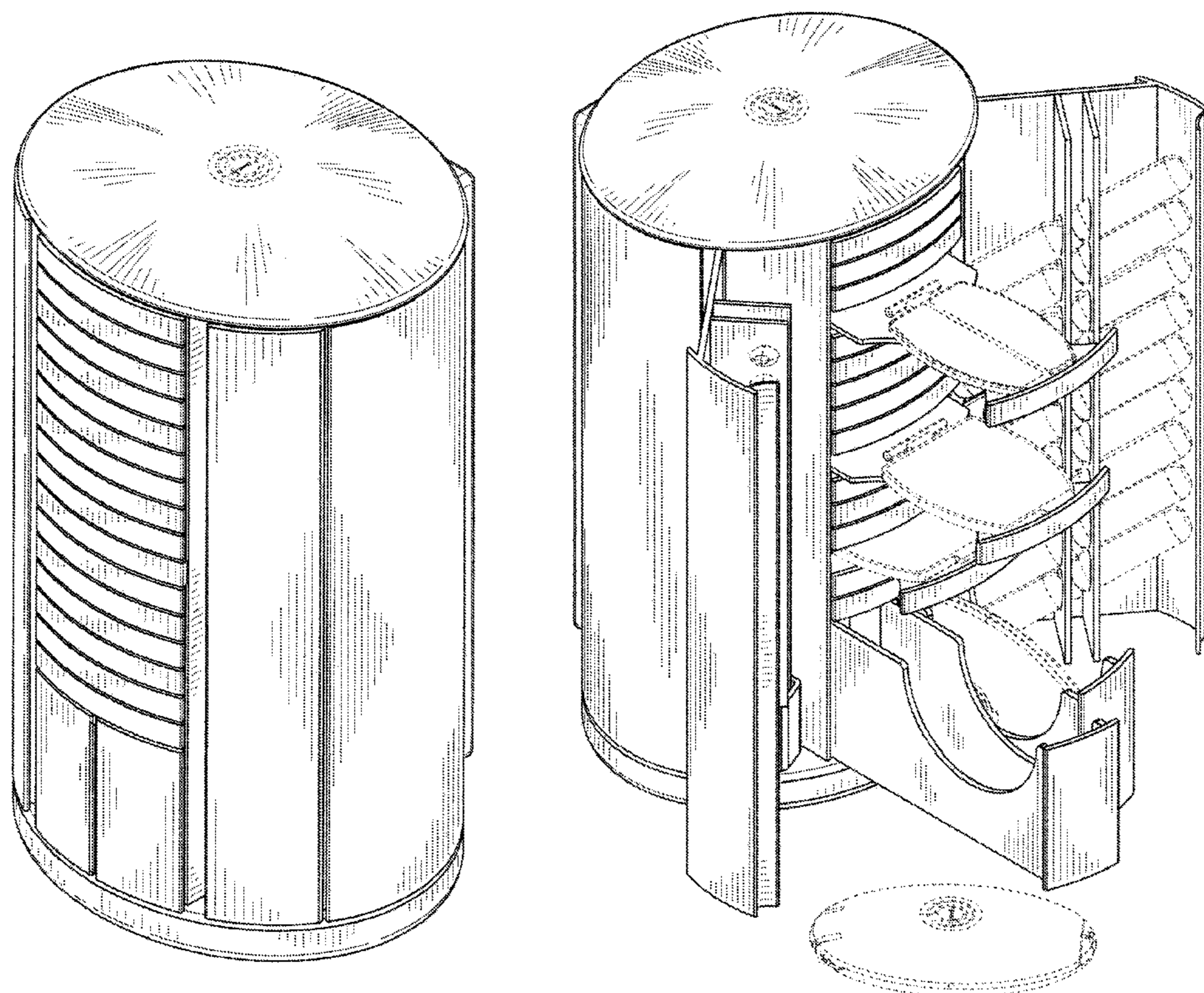

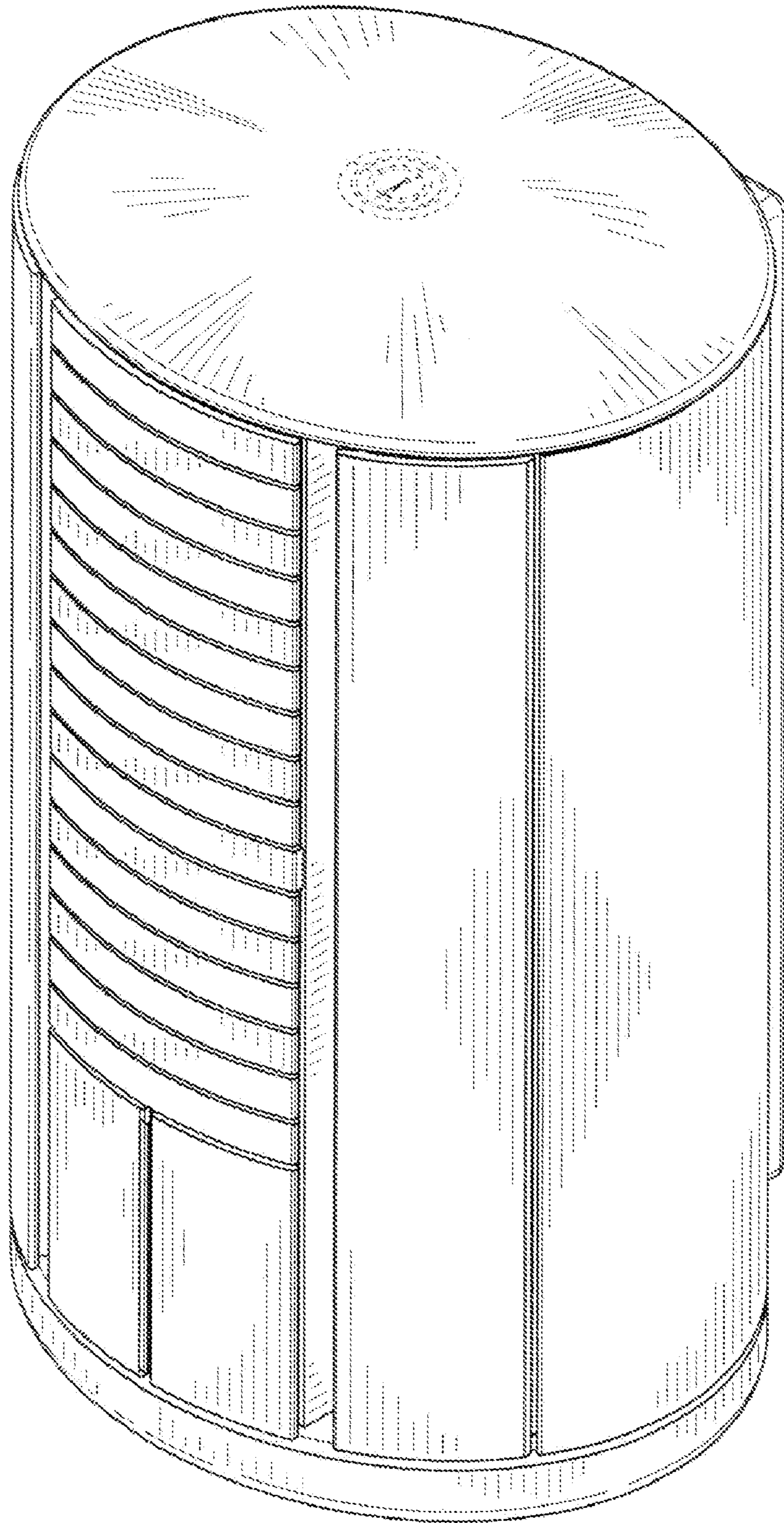

FIG. 1

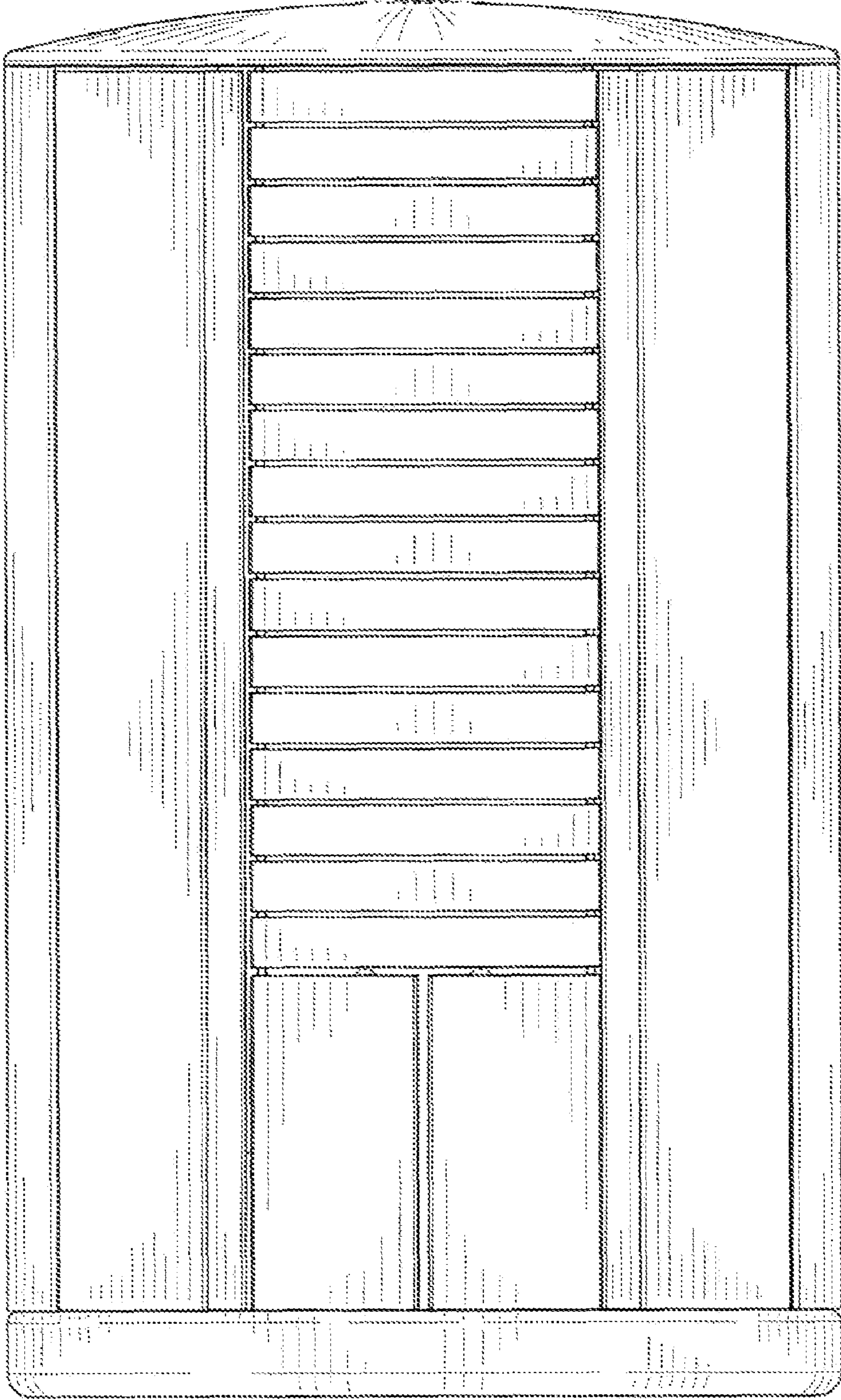

FIG. 2

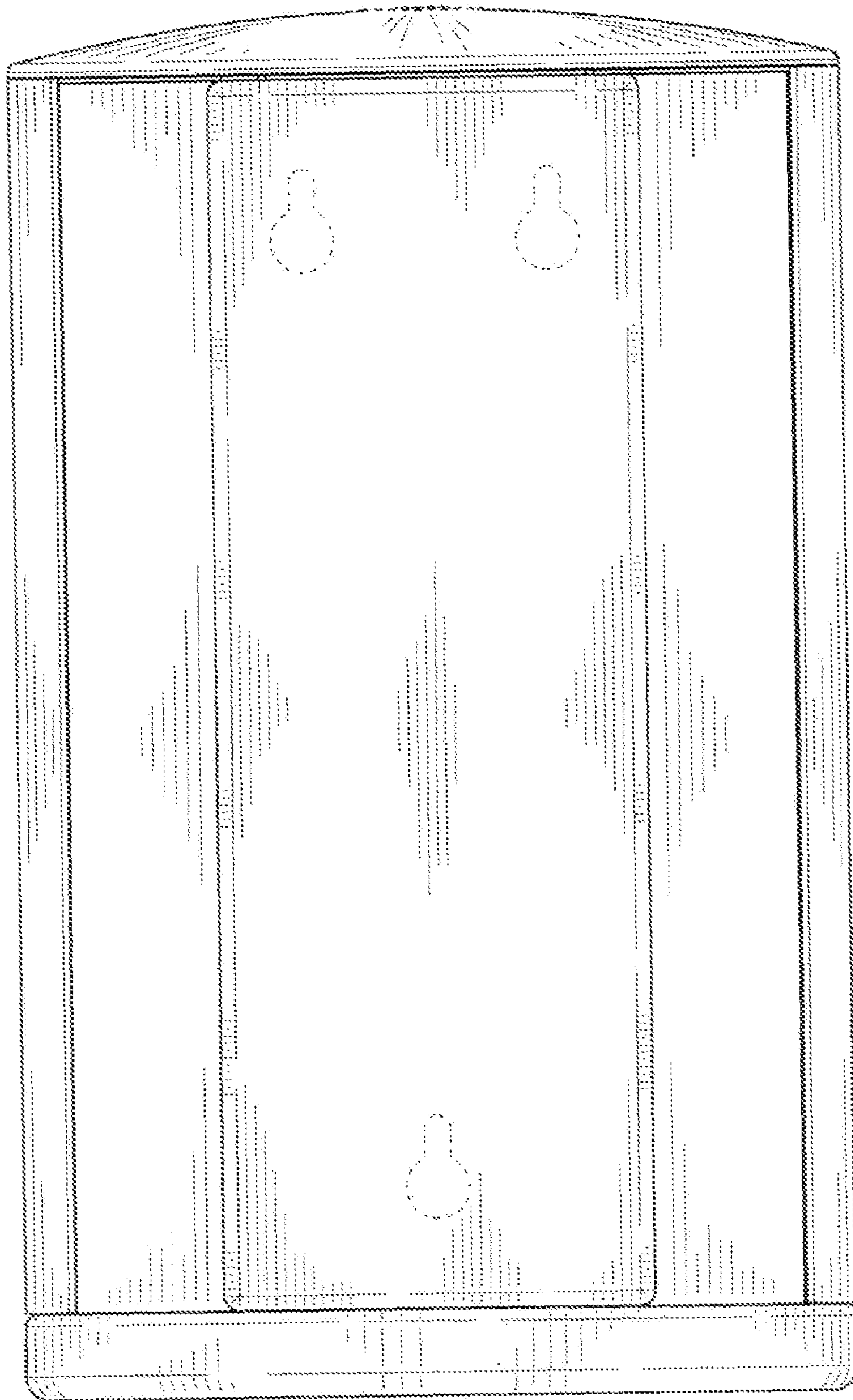

FIG. 3

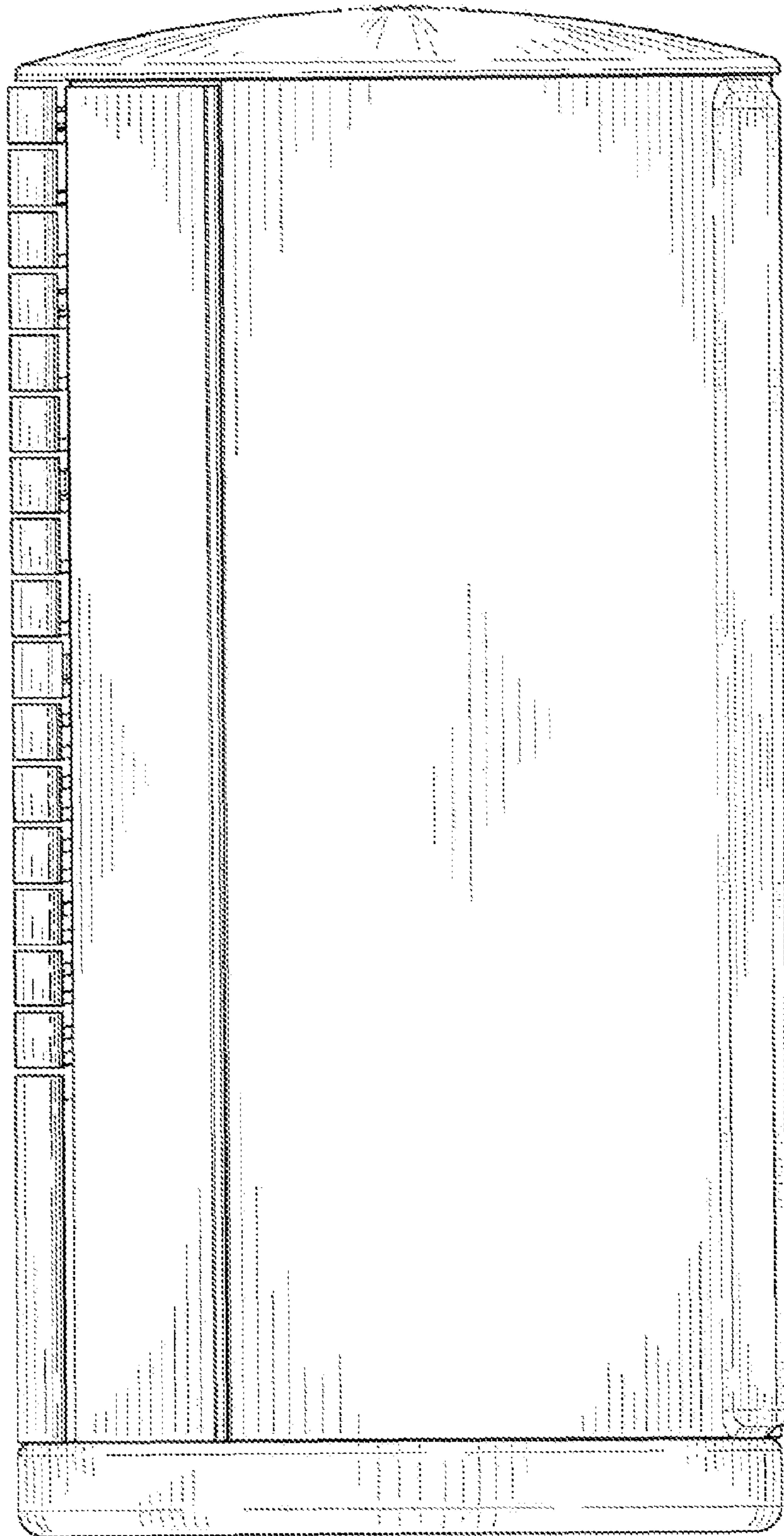

FIG. 4

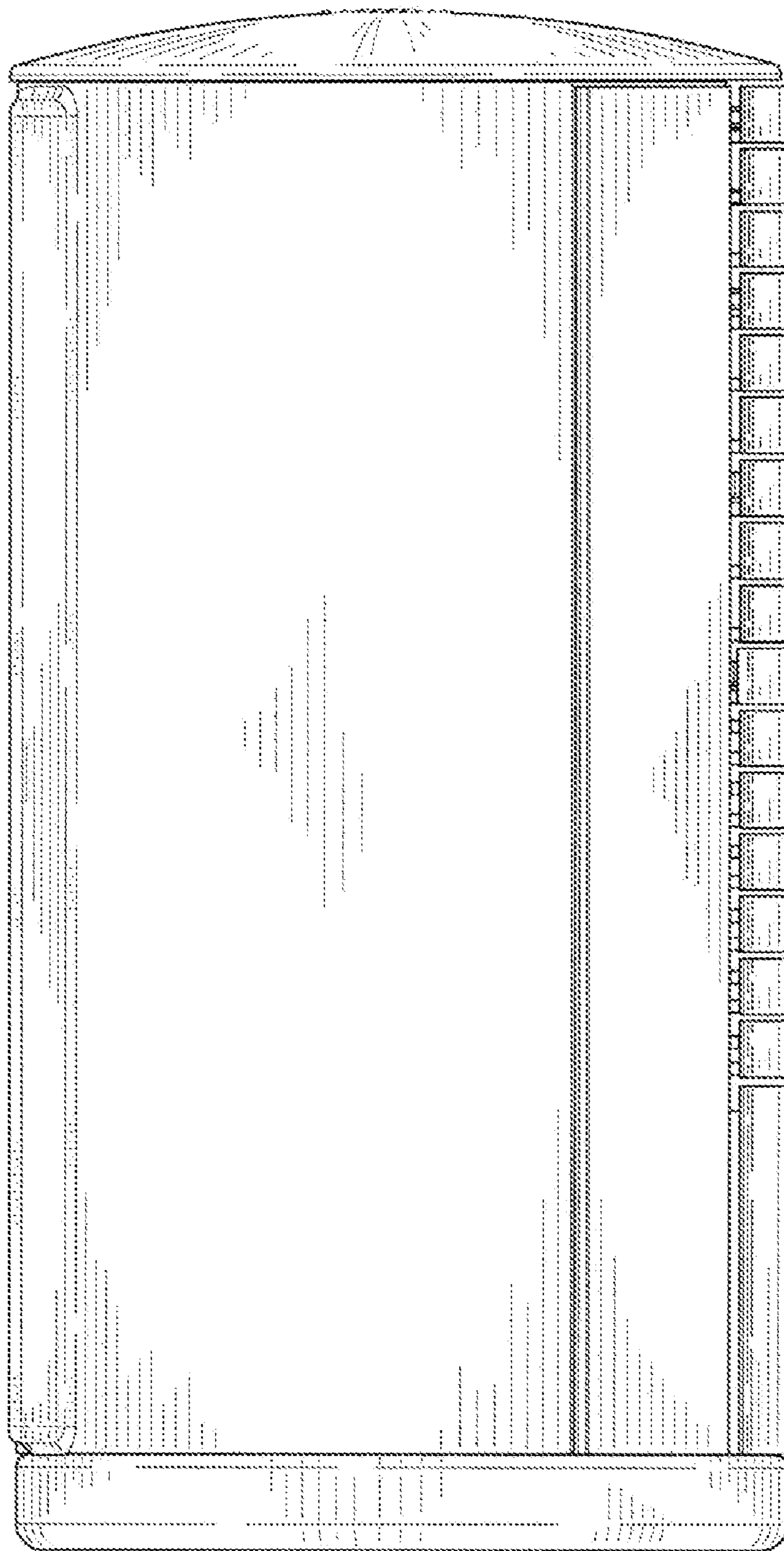

FIG. 5

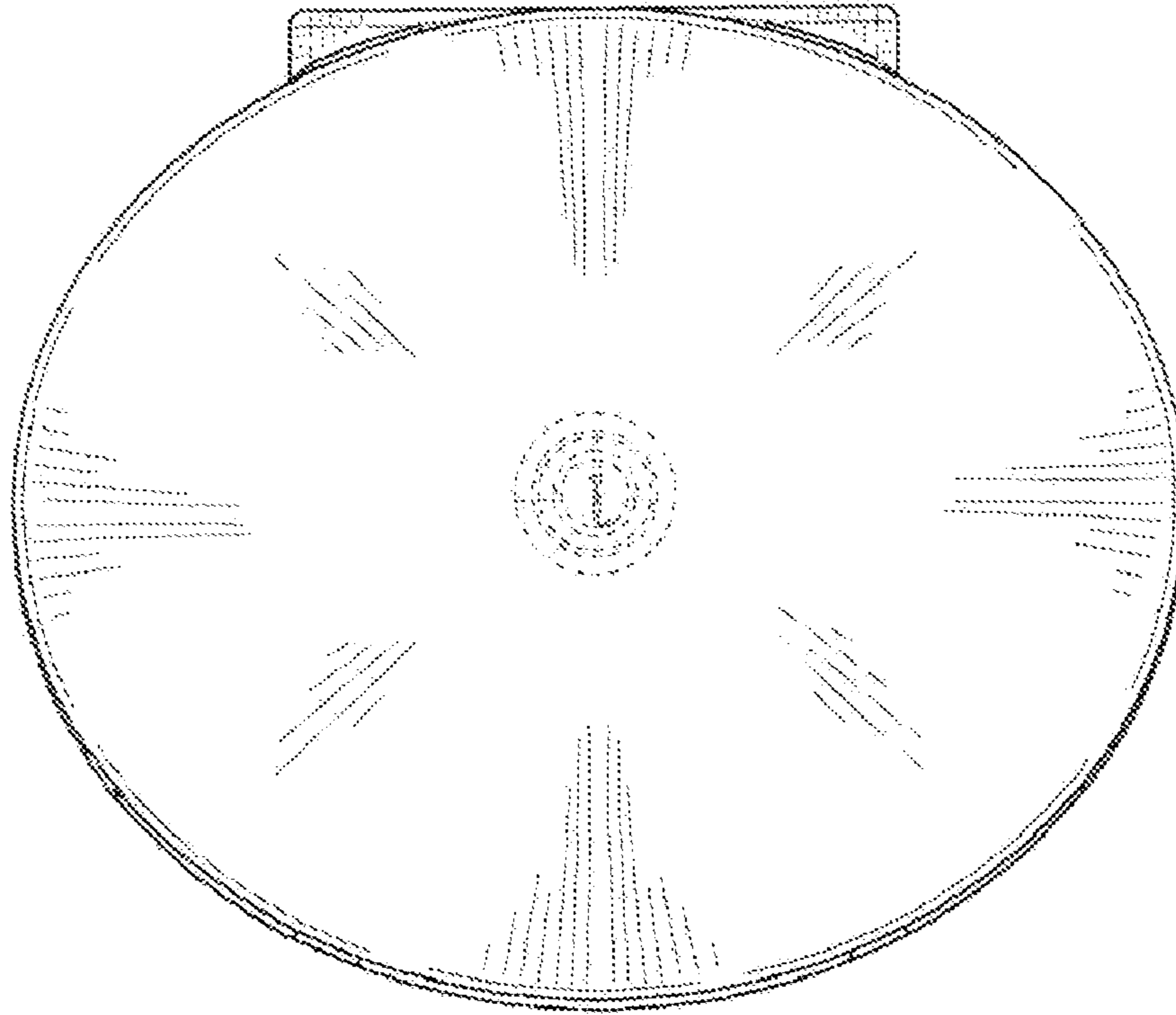

FIG. 6

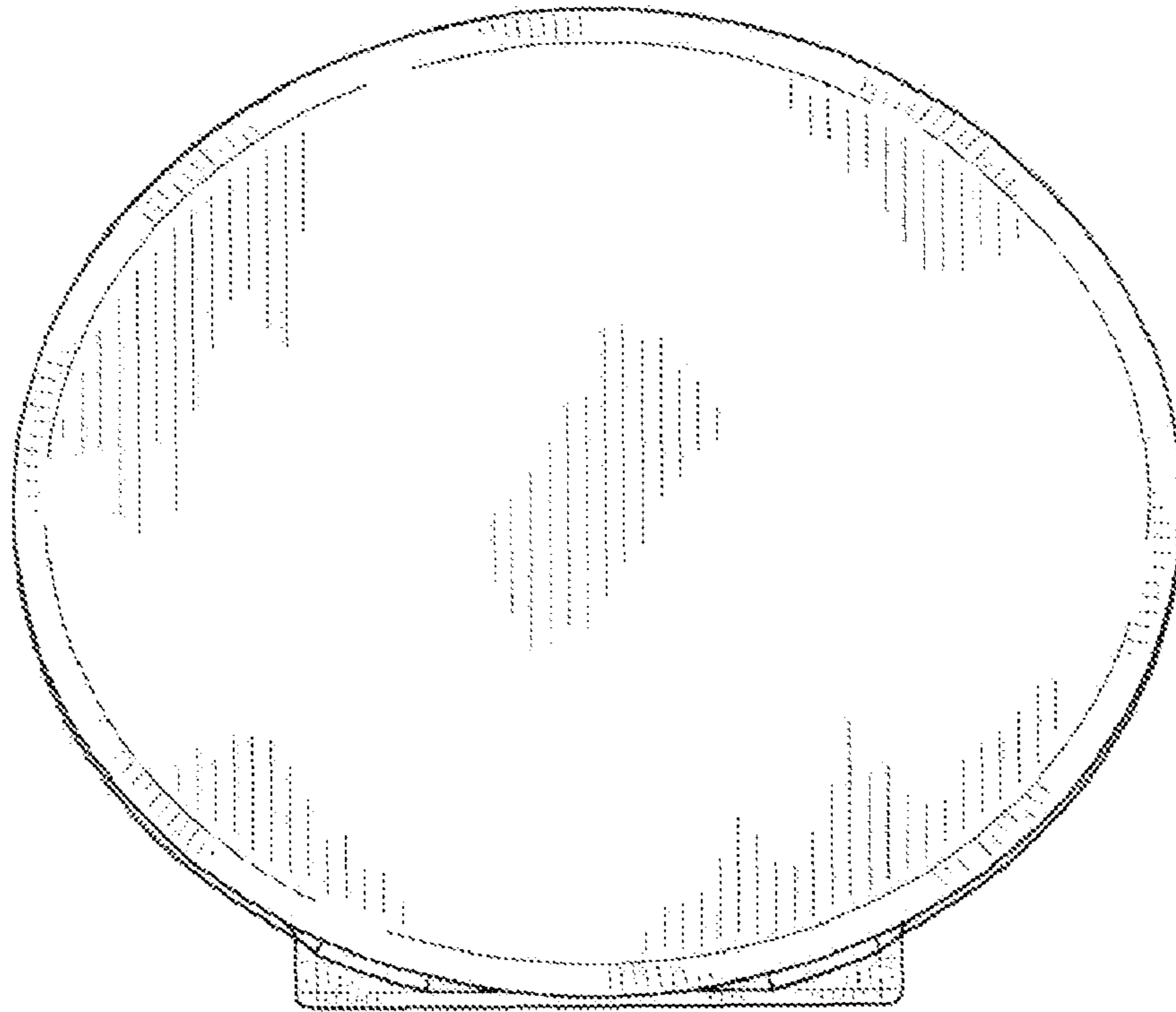

FIG. 7

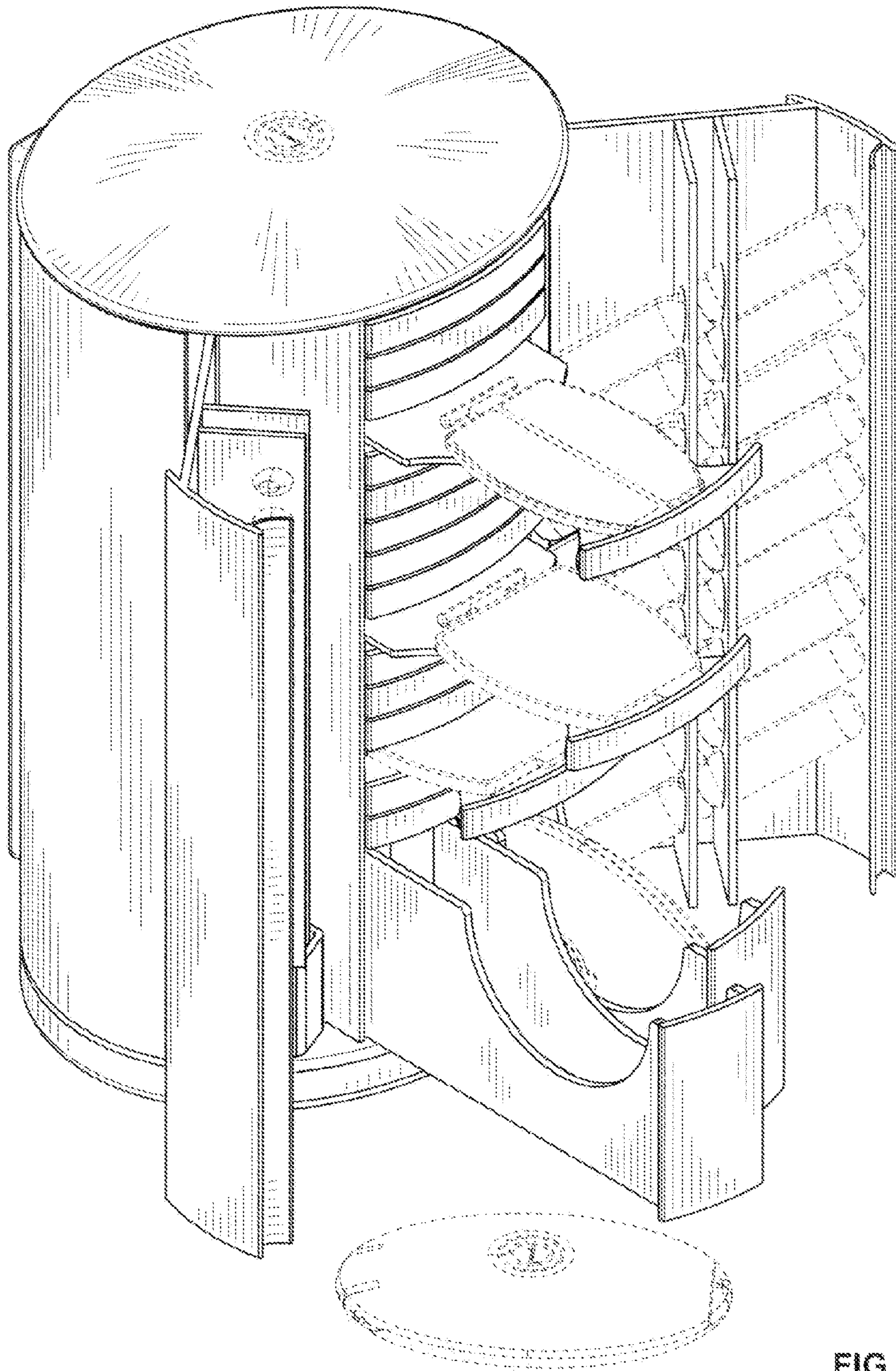

FIG. 8

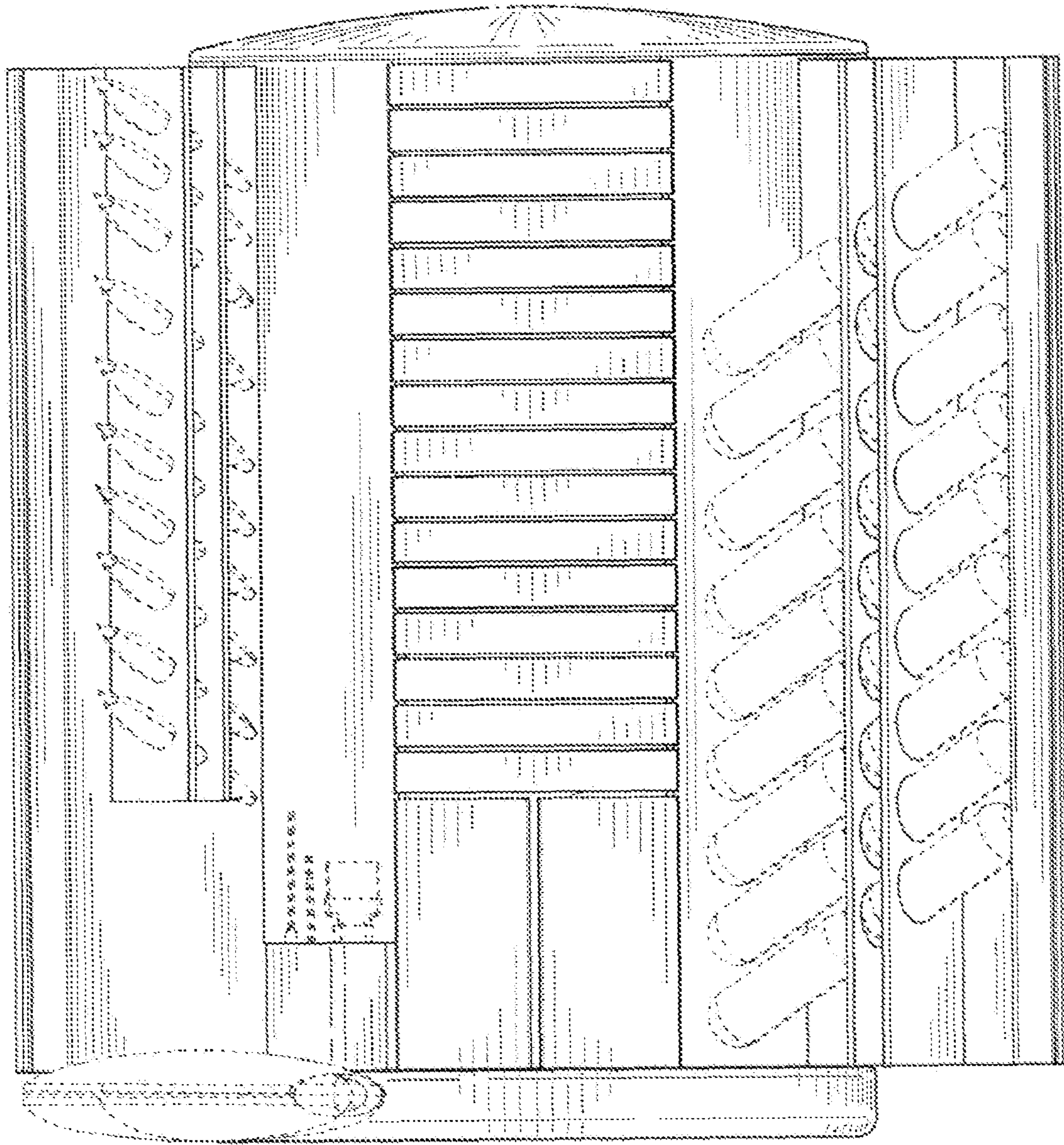

FIG. 9

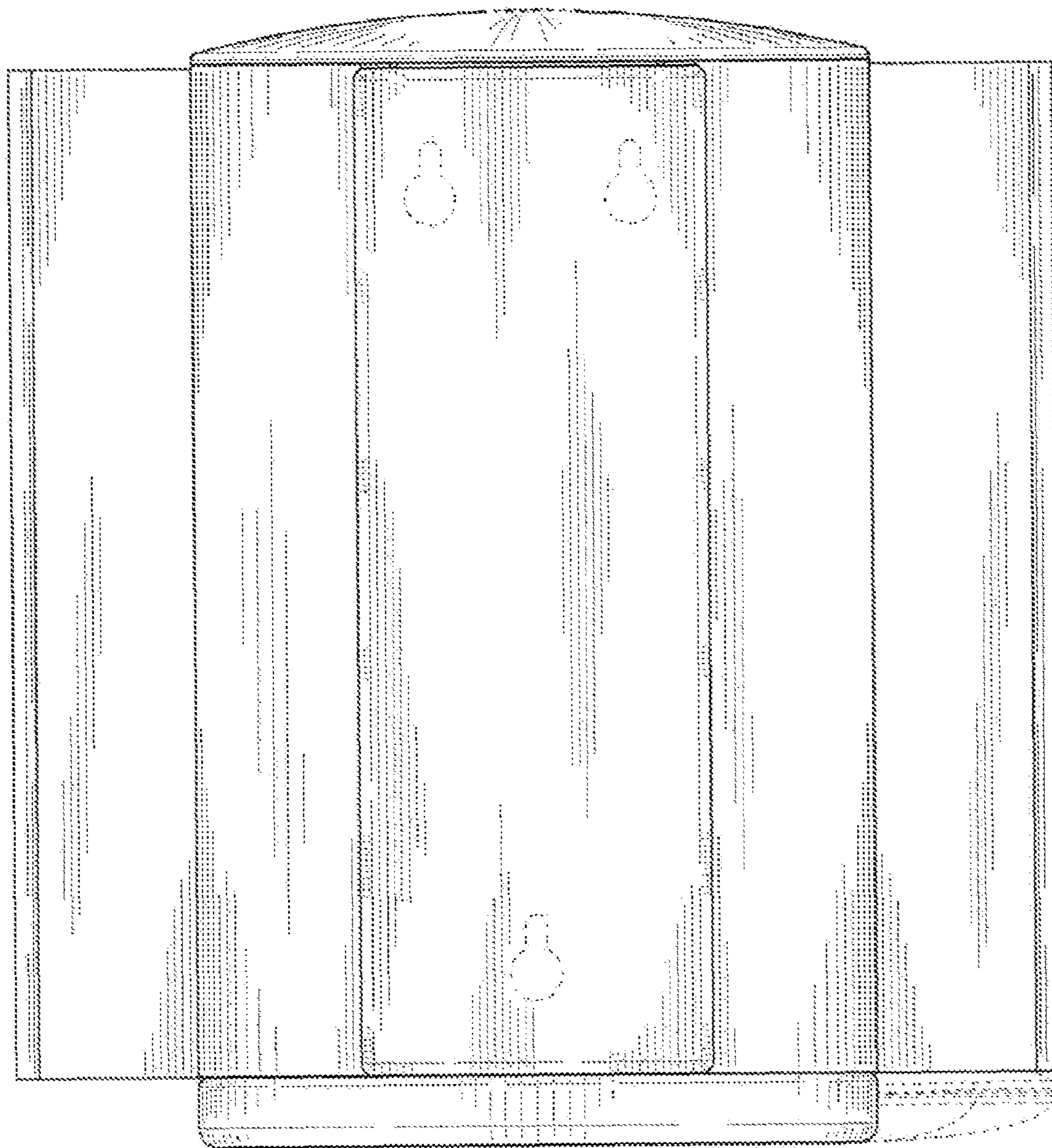

FIG. 10

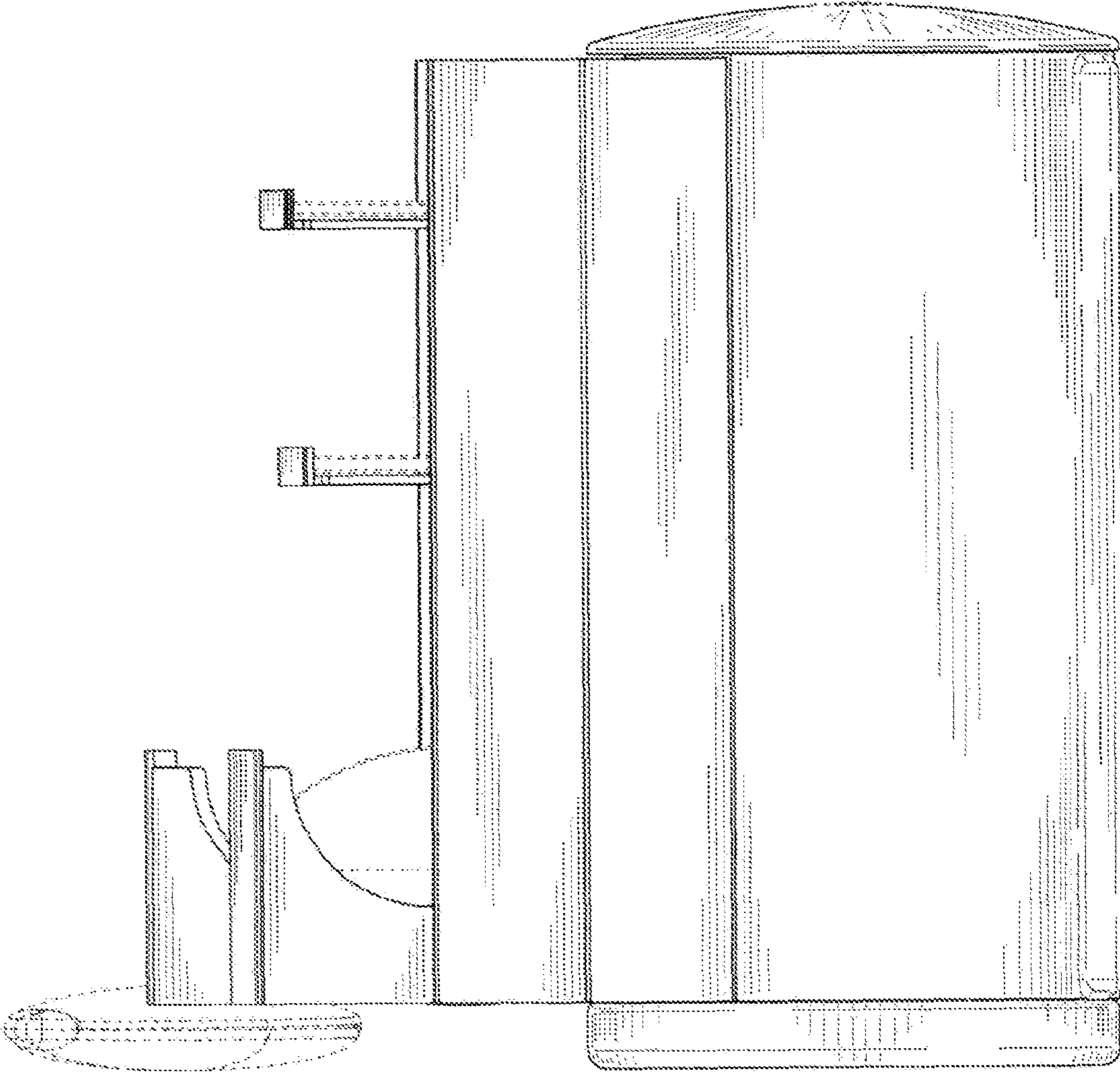

FIG. 11

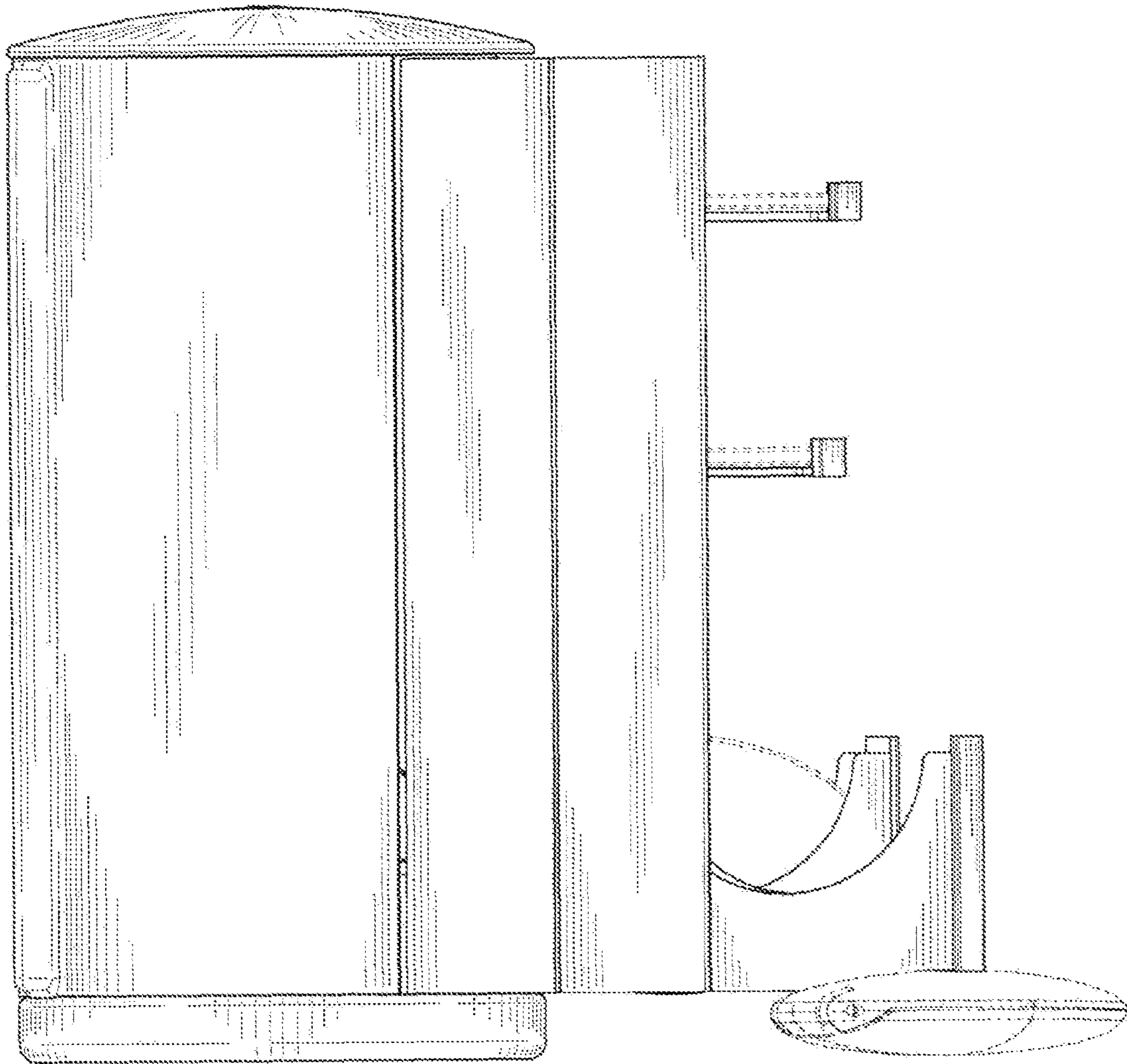

FIG. 12

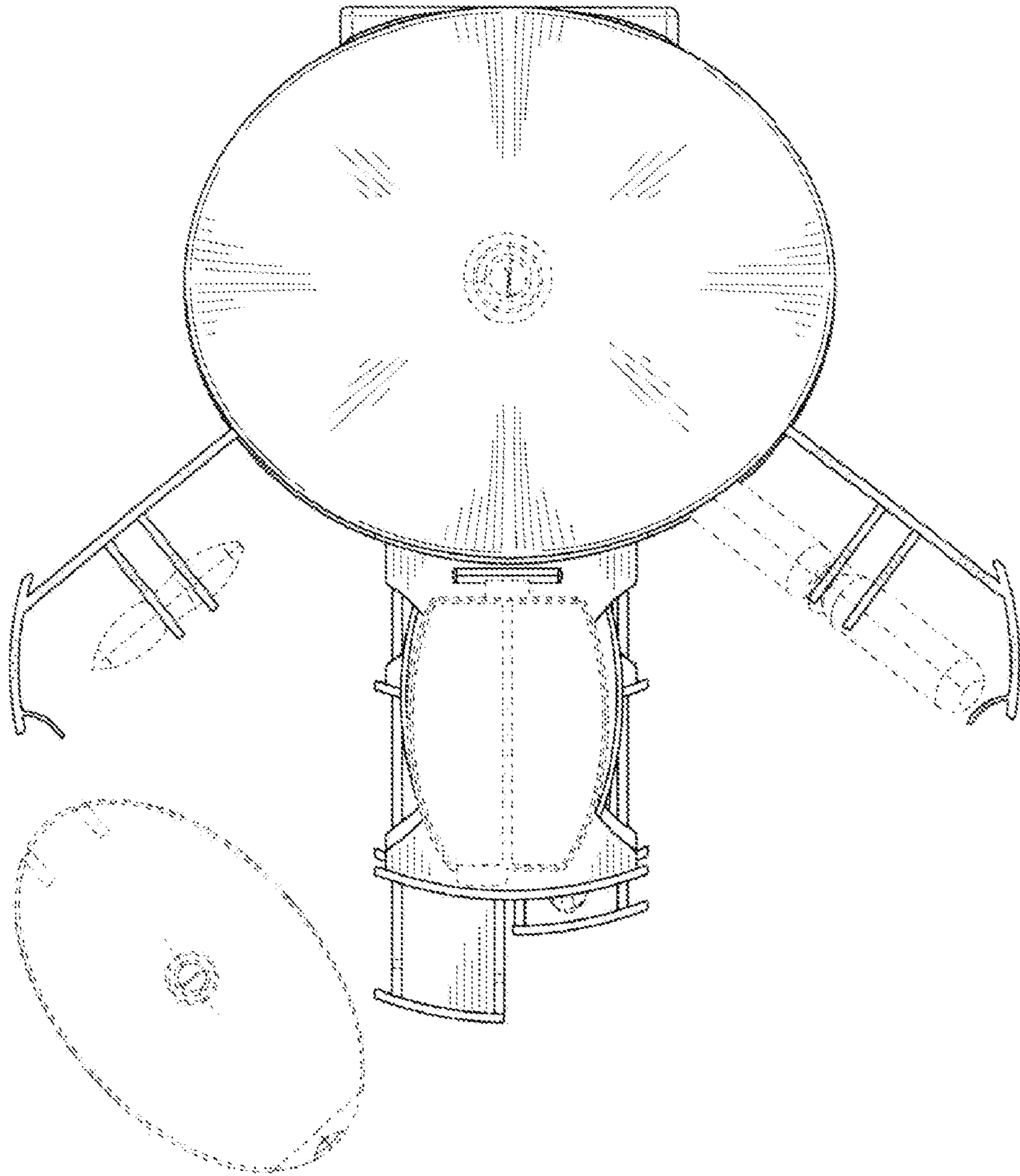

FIG. 13

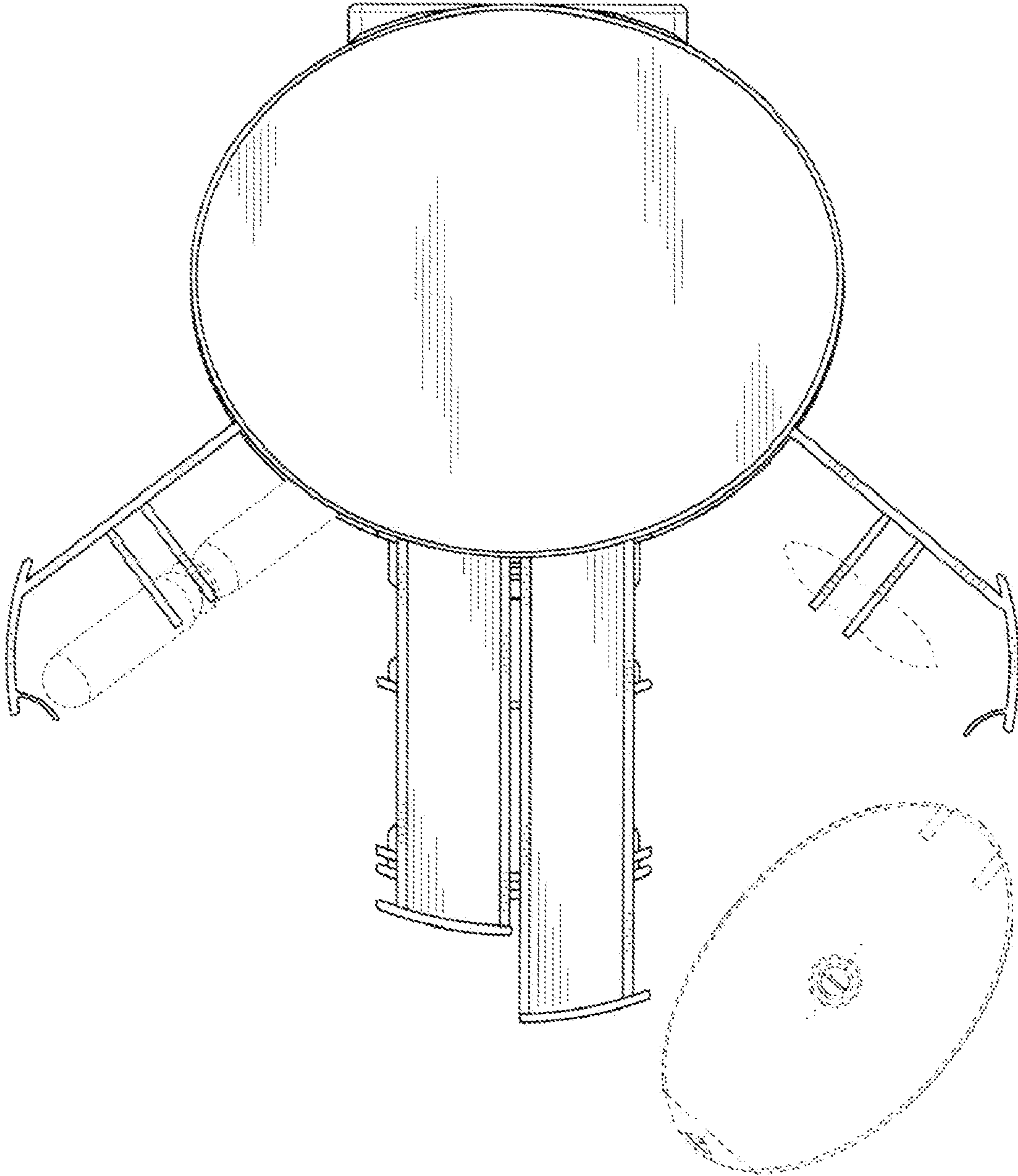

FIG. 14