

US00D560309S

(12) **United States Design Patent**  
**Garland et al.**

(10) **Patent No.:** **US D560,309 S**  
(45) **Date of Patent:** **\*\* Jan. 22, 2008**

(54) **TRIMMER**

(75) Inventors: **Tylor Garland**, Studio City, CA (US);  
**Patrick Burgess**, Jalisco (MX); **Aldis Rauda**, West Hollywood, CA (US);  
**Stan Chudzik**, Alpharetta, GA (US)

(73) Assignee: **Goody Products, Inc.**, Freeport, IL (US)

(\*\*) Term: **14 Years**

(21) Appl. No.: **29/275,613**

(22) Filed: **Dec. 30, 2006**

(51) **LOC (8) Cl.** ..... **28-03**

(52) **U.S. Cl.** ..... **D28/53; D28/49**

(58) **Field of Classification Search** ..... 30/29.5,  
30/201, 34, 34.5, 34.1, 34.2, 41-41.6, 43-43.92,  
30/44-45, 526-533; D28/44, 44.1, 49-54  
See application file for complete search history.

(56) **References Cited**

**U.S. PATENT DOCUMENTS**

D283,060 S \* 3/1986 Camens ..... D28/51

(Continued)

*Primary Examiner*—Jennifer Rivard

(74) *Attorney, Agent, or Firm*—Marshall, Gerstein & Borun LLP

(57) **CLAIM**

The ornamental design for a “trimmer,” as shown and described.

**DESCRIPTION**

FIG. 1 is a perspective view from the front and left of a first embodiment of a trimmer having our new design with the protective caps attached at the ends of the trimmer;

FIG. 2 is a front view thereof;

FIG. 3 is a rear view thereof;

FIG. 4 is a left side elevational view thereof;

FIG. 5 is a right side elevational view thereof;

FIG. 6 is a top view thereof;

FIG. 7 is a bottom view thereof;

FIG. 8 is a perspective view from the front and right of the trimmer of FIG. 1 with the protective caps removed;

FIG. 9 is a front view thereof;

FIG. 10 is a rear view thereof;

FIG. 11 is a right side elevational view thereof;

FIG. 12 is a left side elevational view thereof;

FIG. 13 is a top view thereof;

FIG. 14 is a bottom view thereof;

FIG. 15 is a right side elevational view thereof with trimmer head rotated to a second position;

FIG. 16 is a perspective view from the front and left of a second embodiment of a trimmer having our new design with the protective caps attached at the ends of the trimmer;

FIG. 17 is a front view thereof;

FIG. 18 is a rear view thereof;

FIG. 19 is a left side elevational view thereof;

FIG. 20 is a right side elevational view thereof;

FIG. 21 is a top view thereof;

FIG. 22 is a bottom view thereof;

FIG. 23 is a perspective view from the front and right of the trimmer of FIG. 16 with the protective caps removed;

FIG. 24 is a front view thereof;

FIG. 25 is a rear view thereof;

FIG. 26 is a right side elevational view thereof;

FIG. 27 is a left side elevational view thereof;

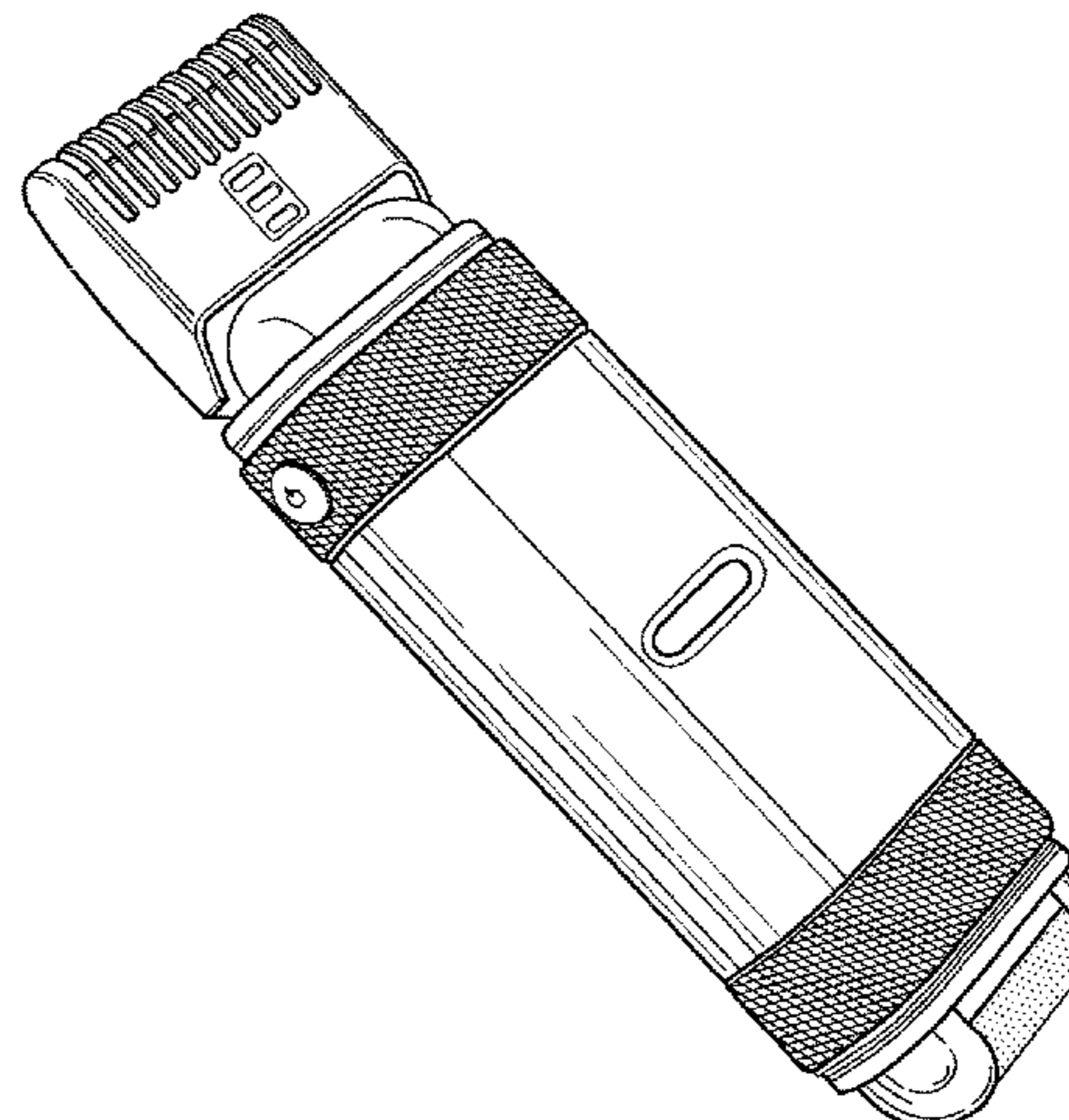
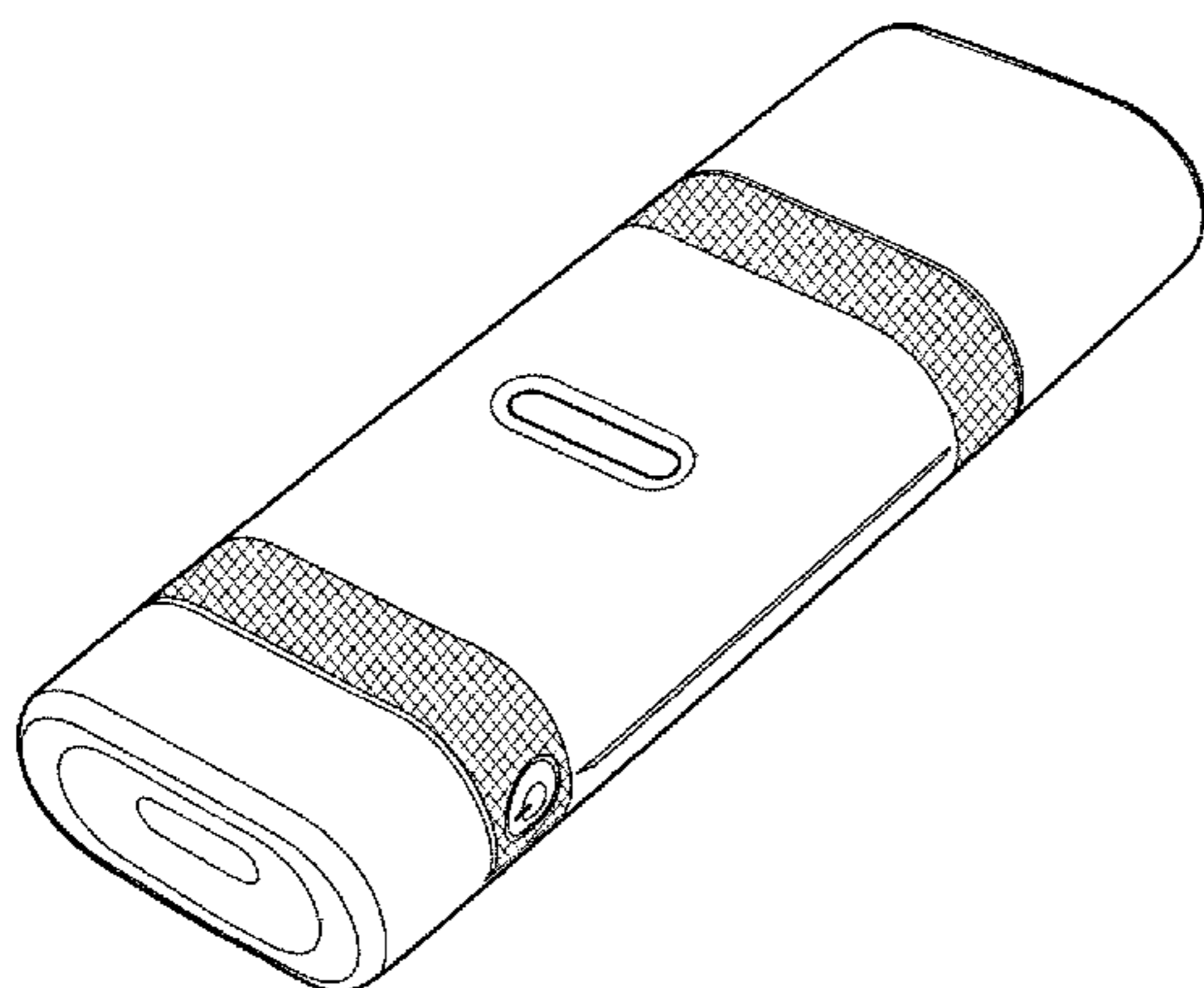
FIG. 28 is a top view thereof;

FIG. 29 is a bottom view thereof; and,

FIG. 30 is a right side elevational view thereof with trimmer head rotated to a second position.

In FIGS. 8-15 and 23-30, the caps have been removed from the trimmers for convenience of illustration.

**1 Claim, 8 Drawing Sheets**



# US D560,309 S

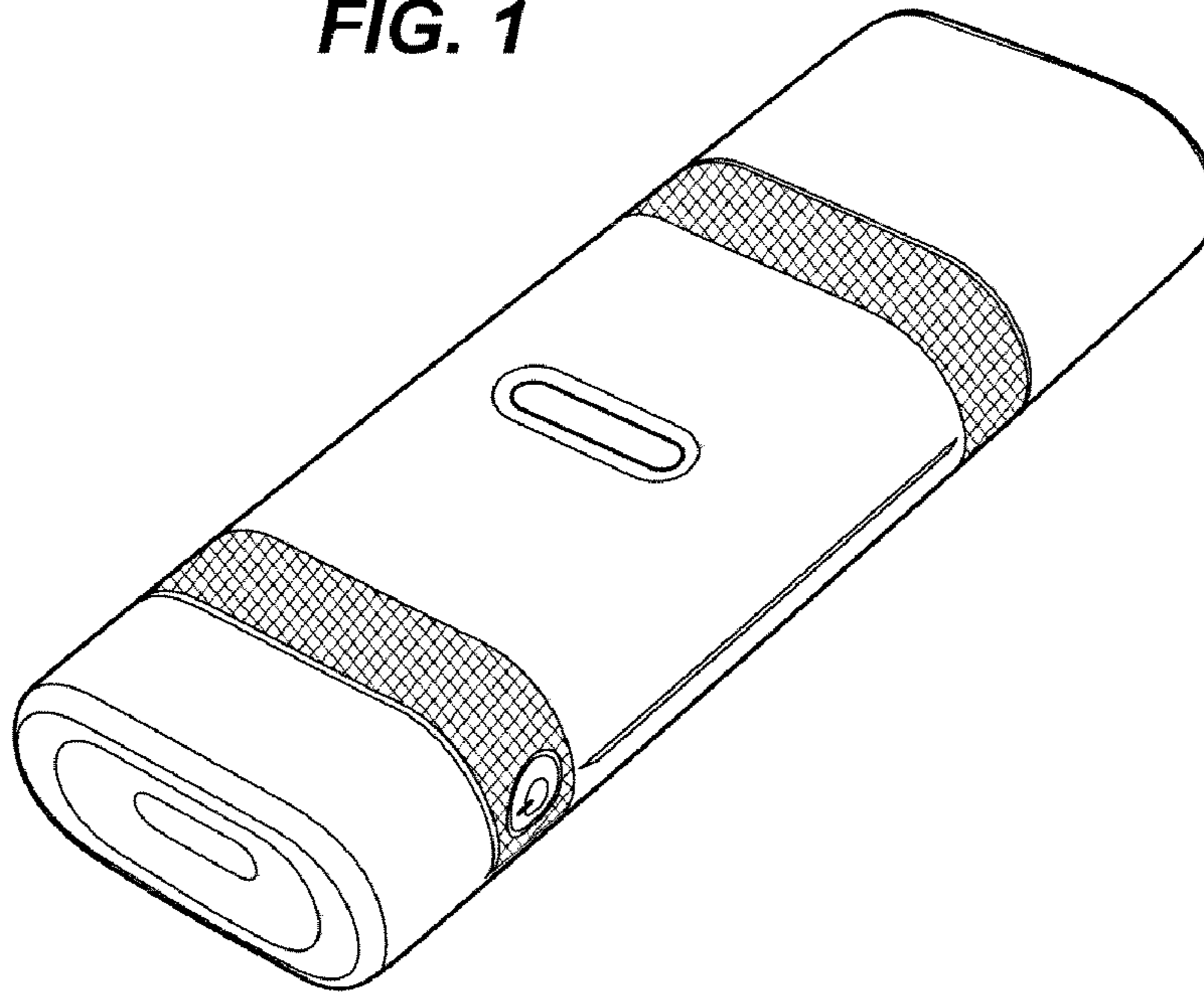
Page 2

---

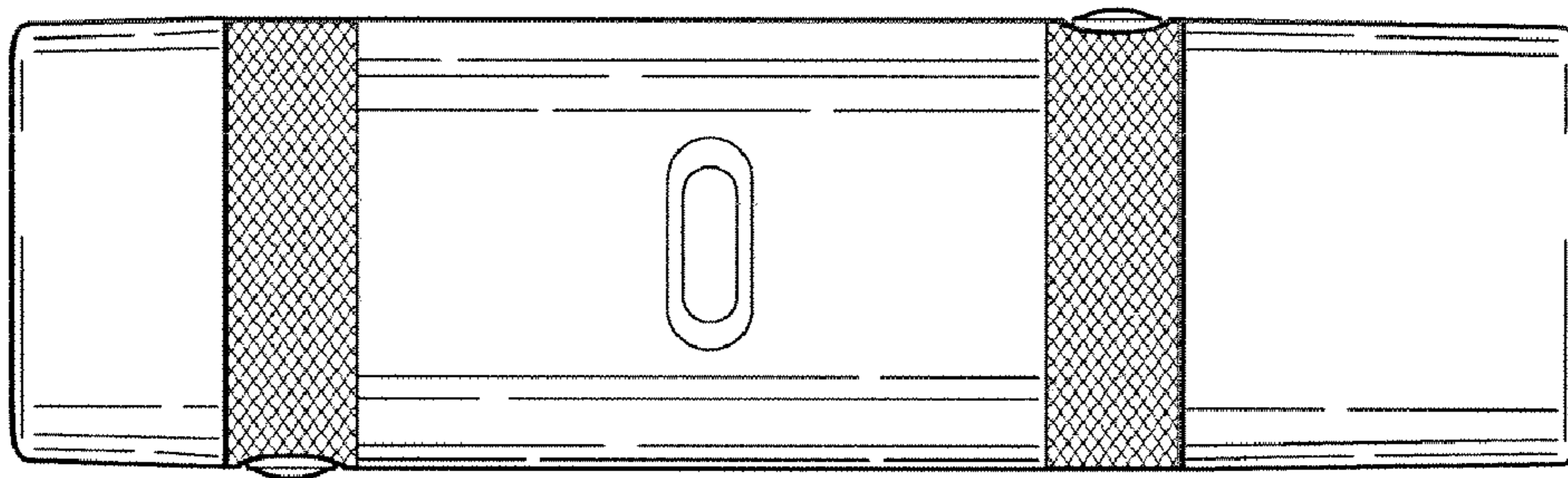
## U.S. PATENT DOCUMENTS

D306,499 S *	3/1990	Lee .....	D28/50	
D341,907 S *	11/1993	Ullmann .....	D28/49	
				* cited by examiner
D408,585 S *	4/1999	Watanabe et al. ....	D28/49	
D517,730 S *	3/2006	Bauwens .....	D28/53	

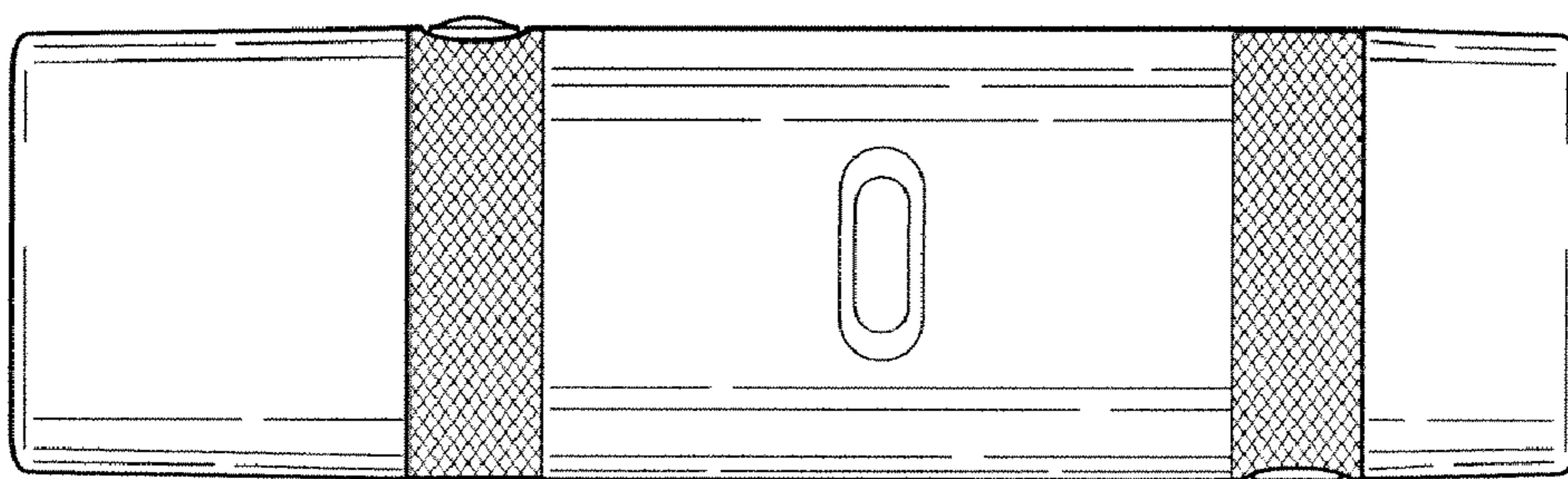
**FIG. 1**



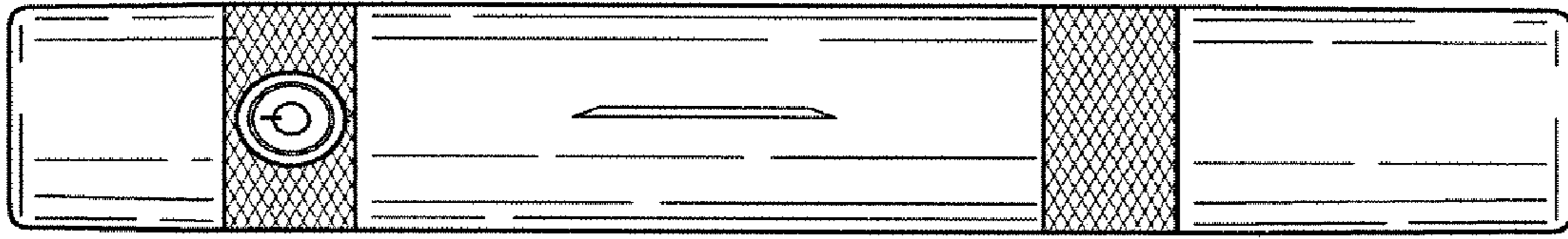
**FIG. 2**



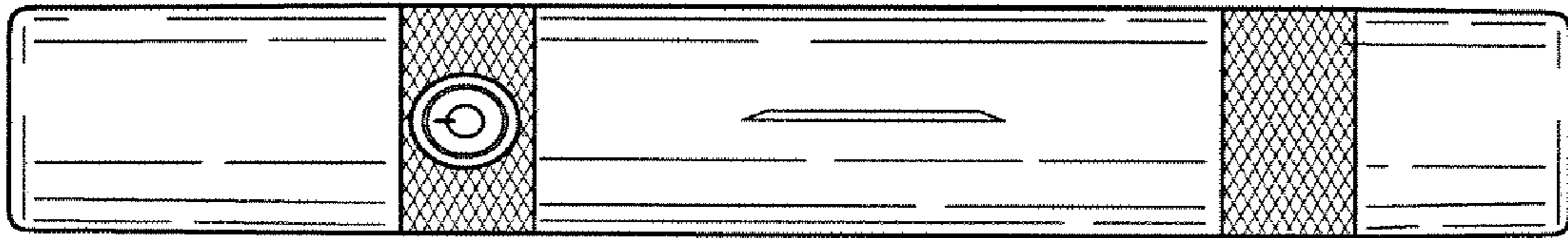
**FIG. 3**



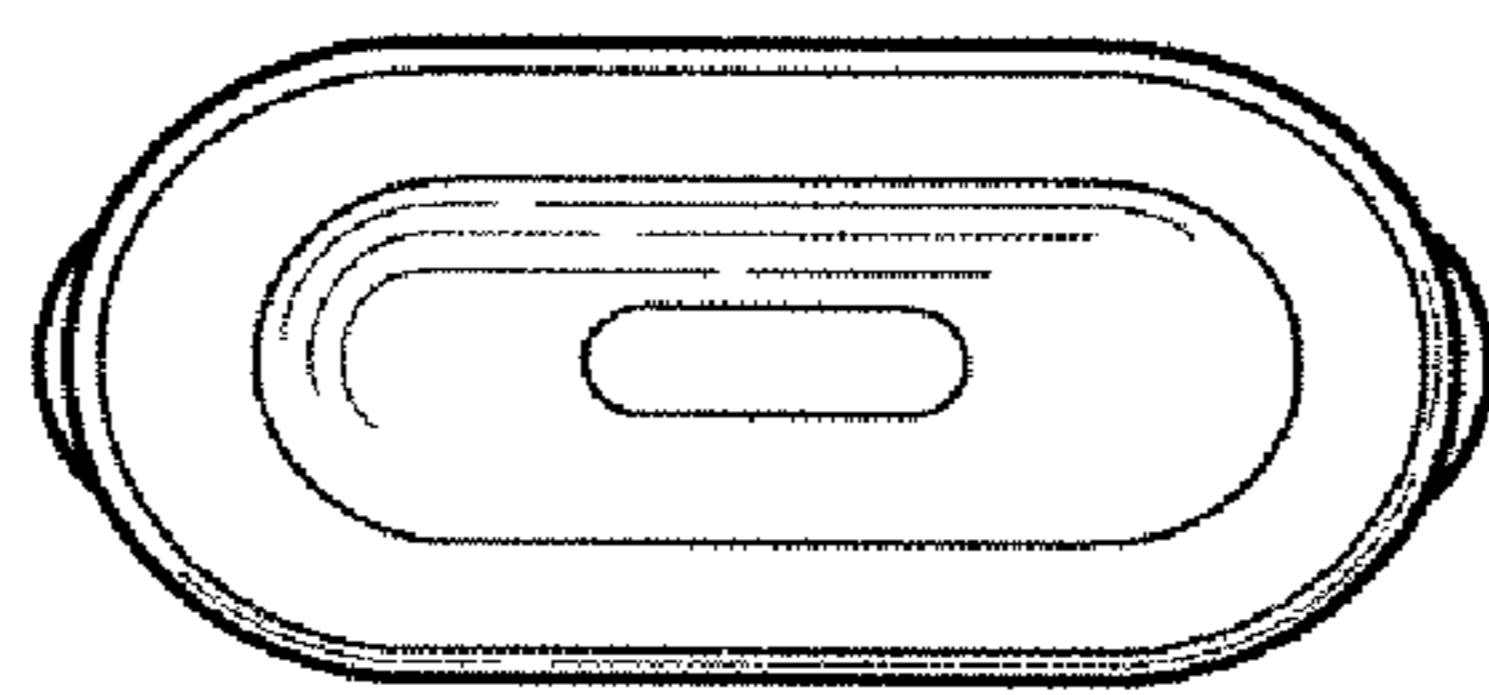
**FIG. 4**



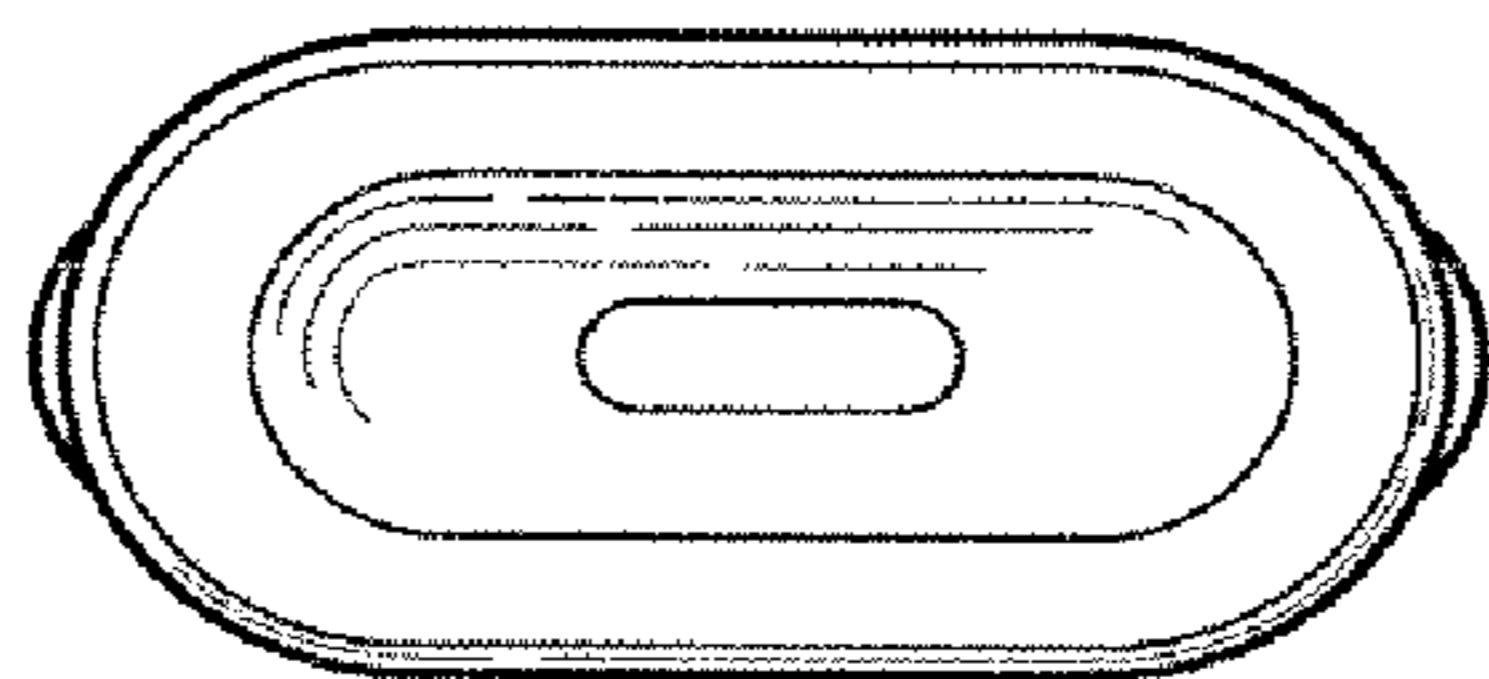
**FIG. 5**

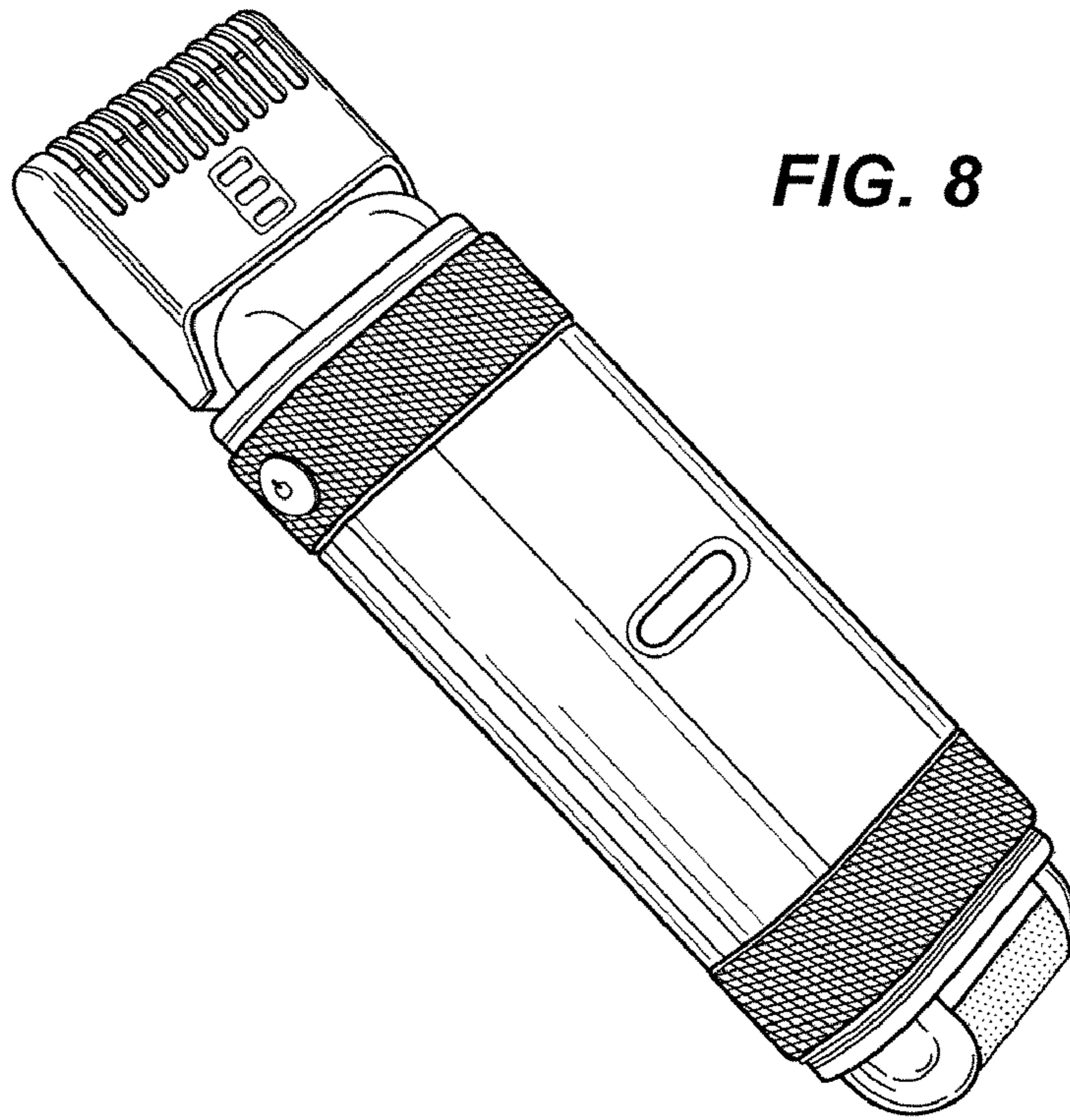


**FIG. 6**



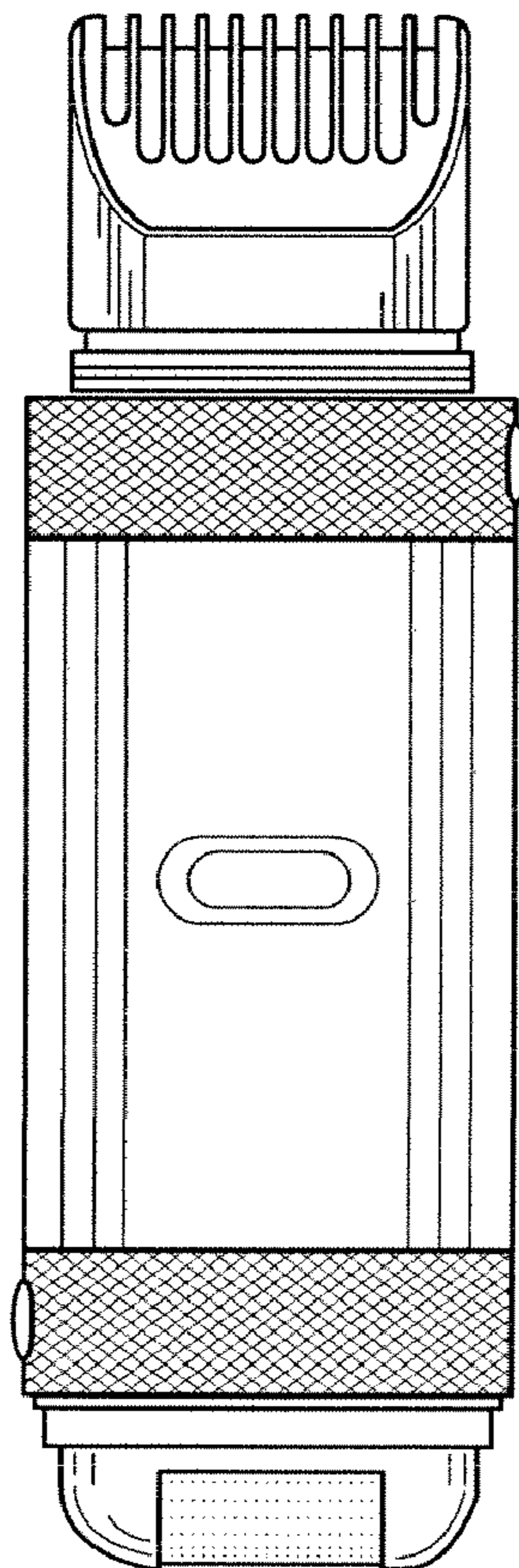
**FIG. 7**



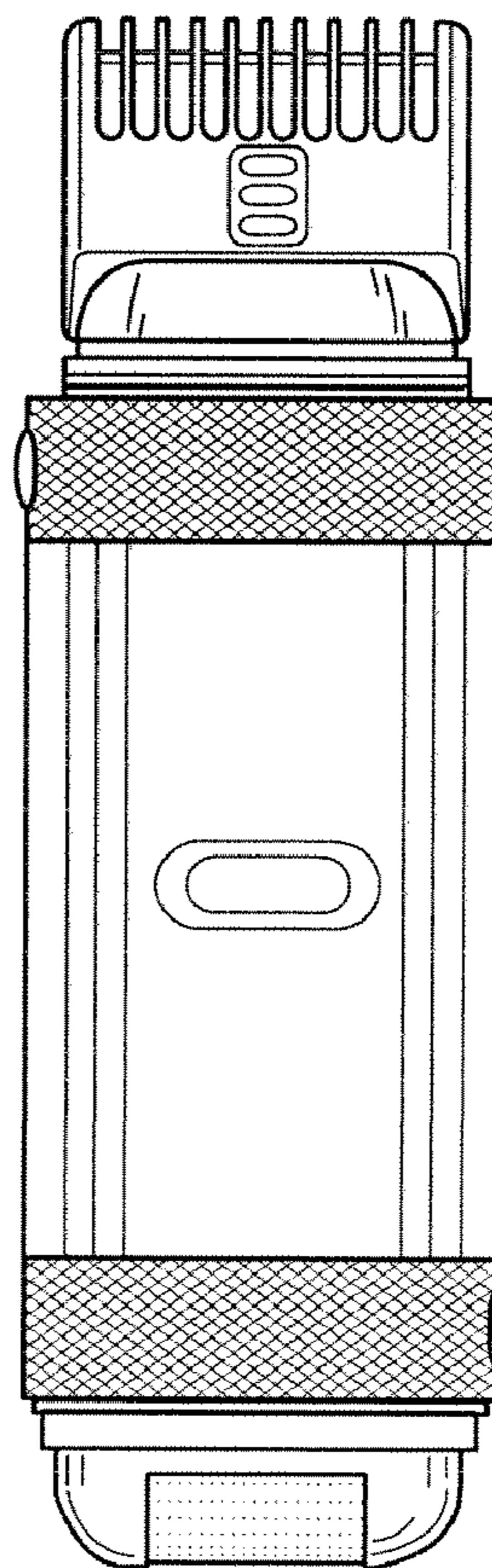


**FIG. 8**

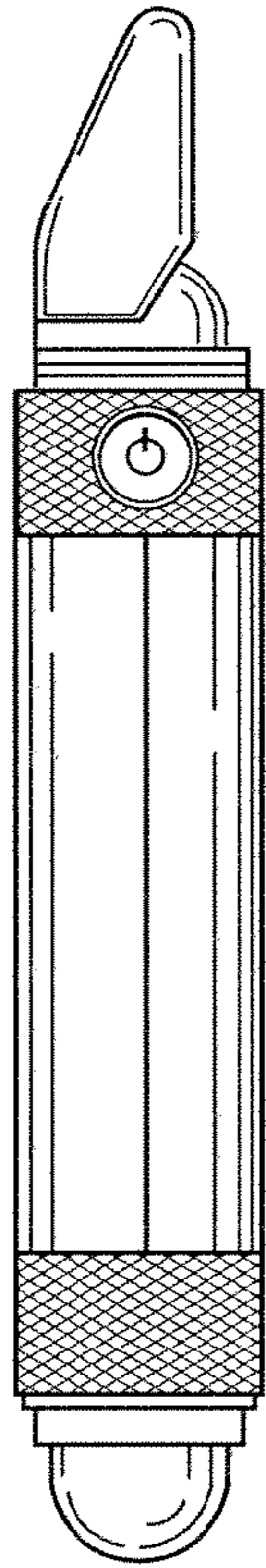
**FIG. 9**



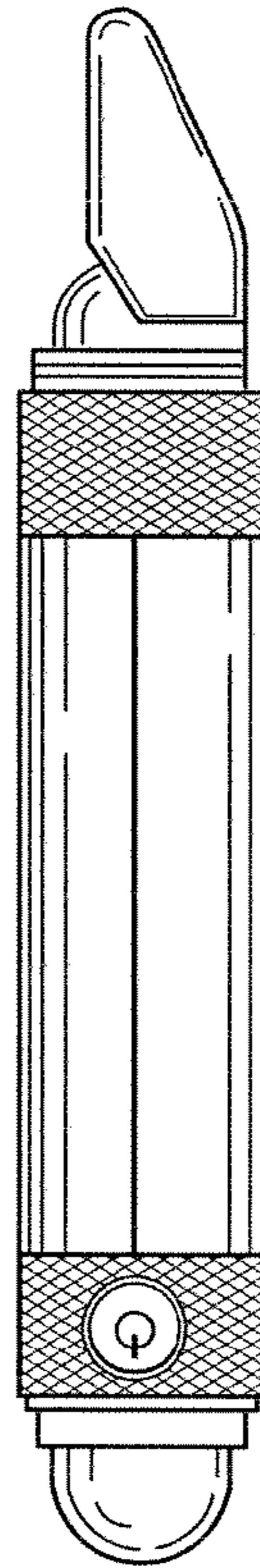
**FIG. 10**



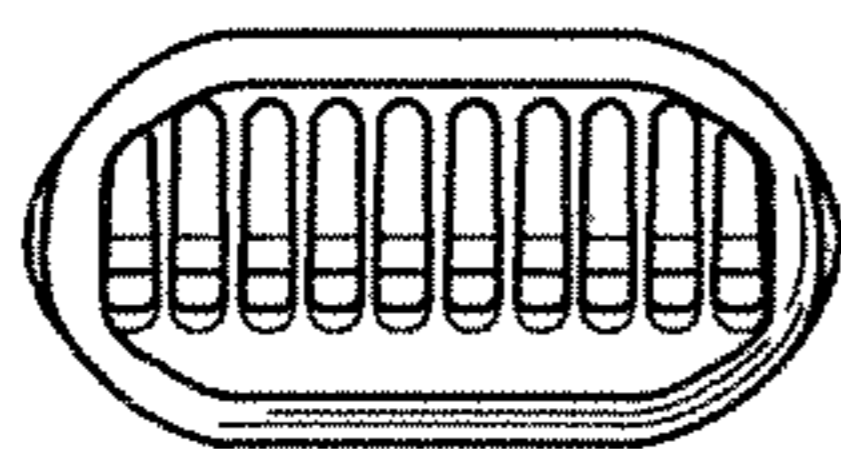
**FIG. 11**



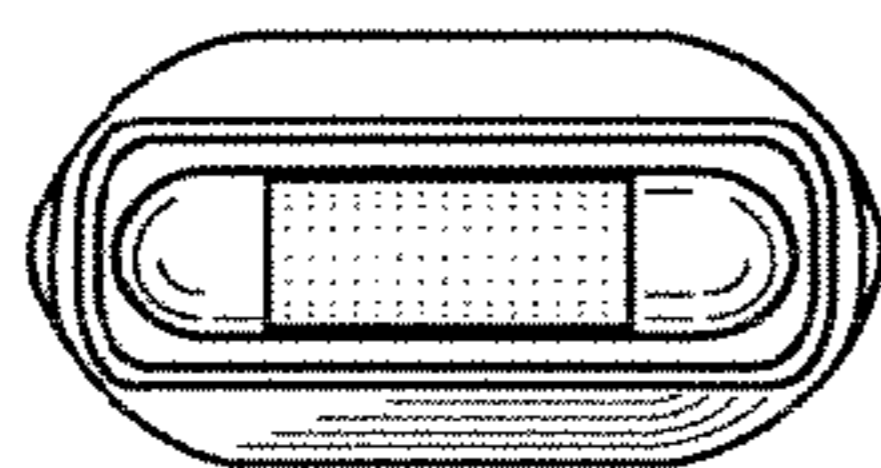
**FIG. 12**



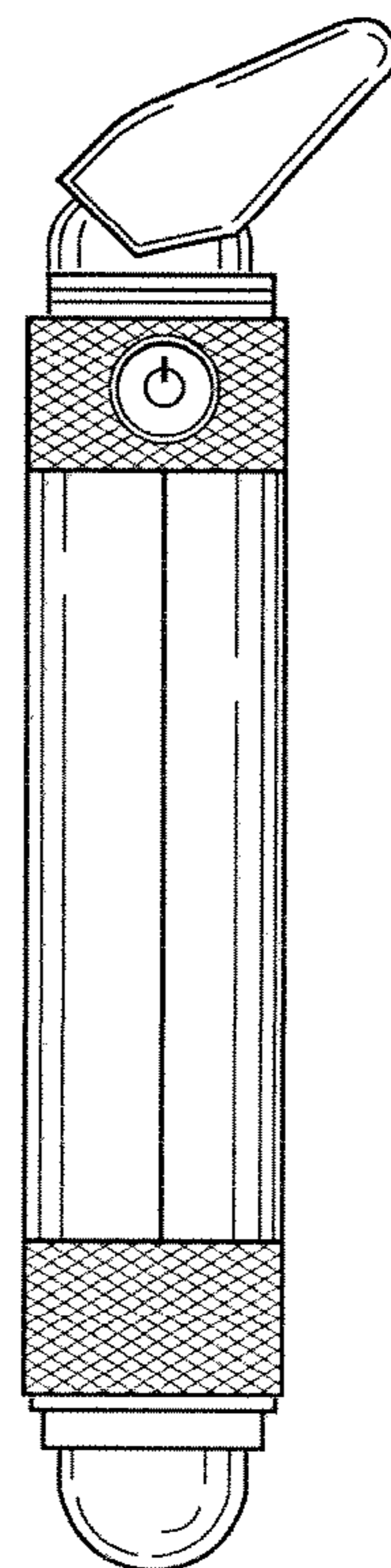
**FIG. 13**



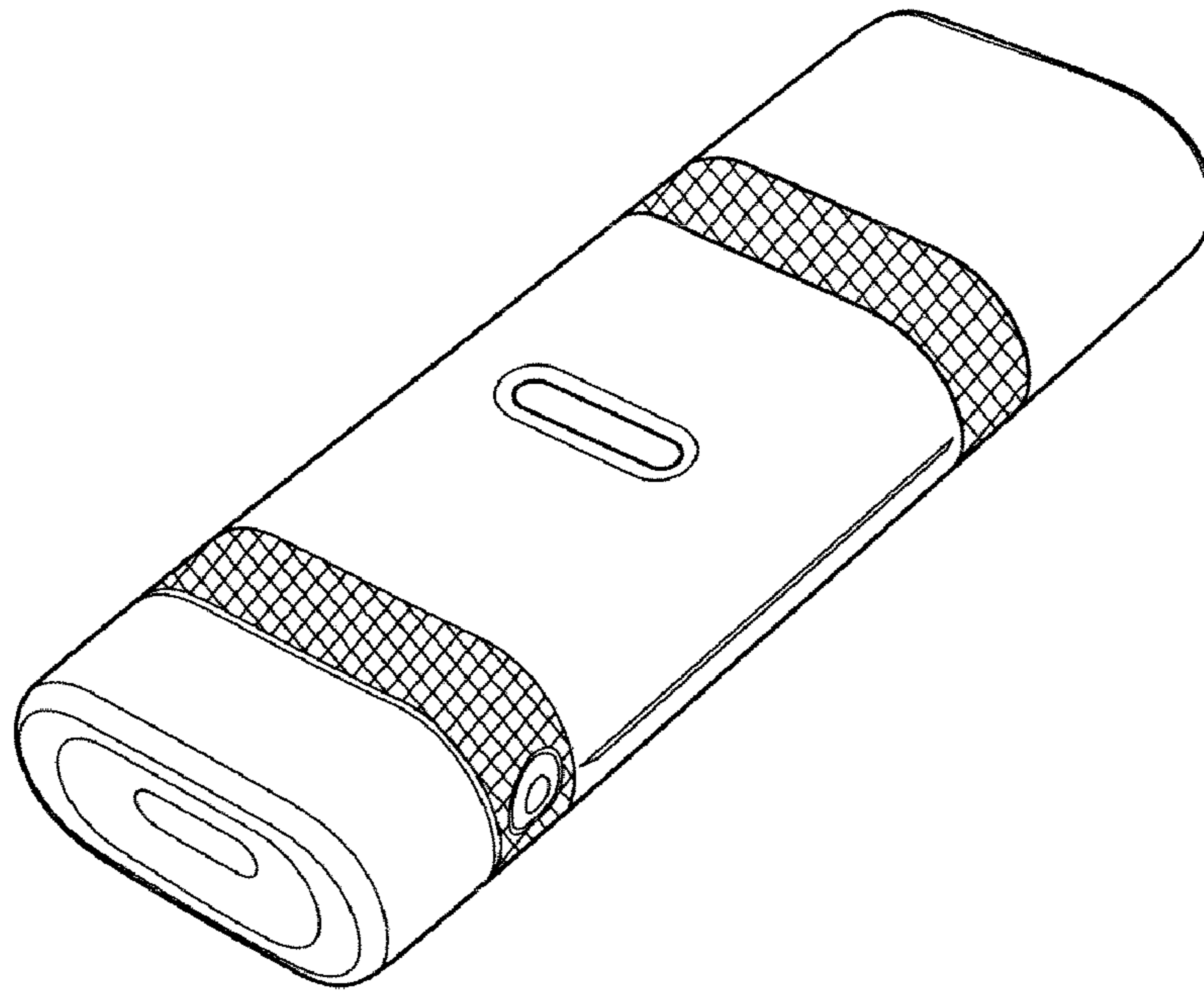
**FIG. 14**



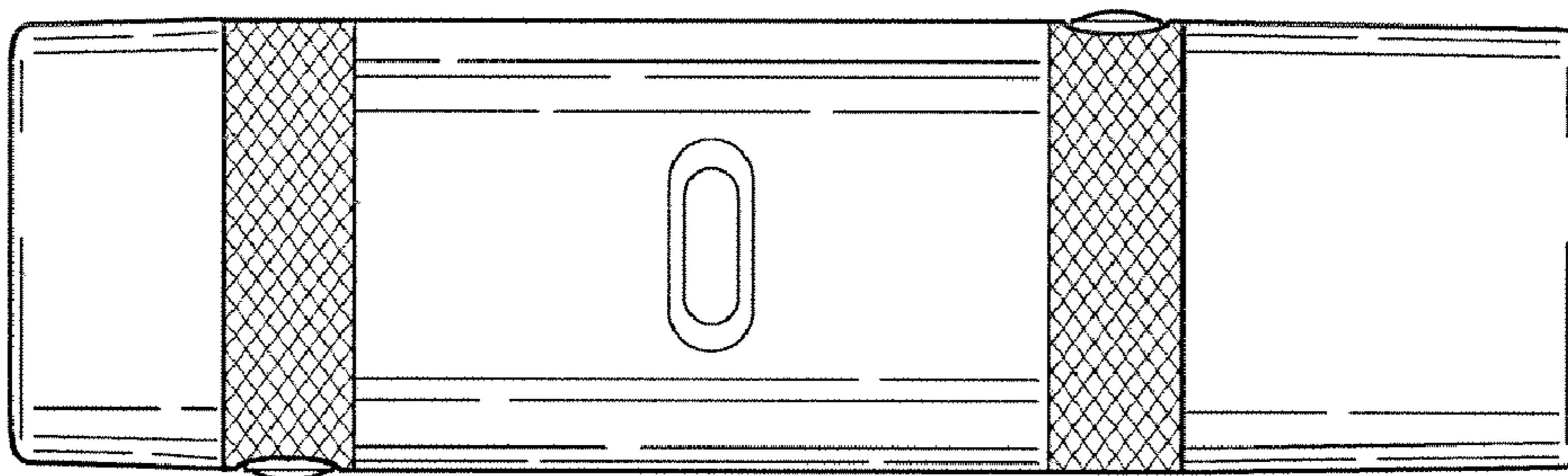
**FIG. 15**



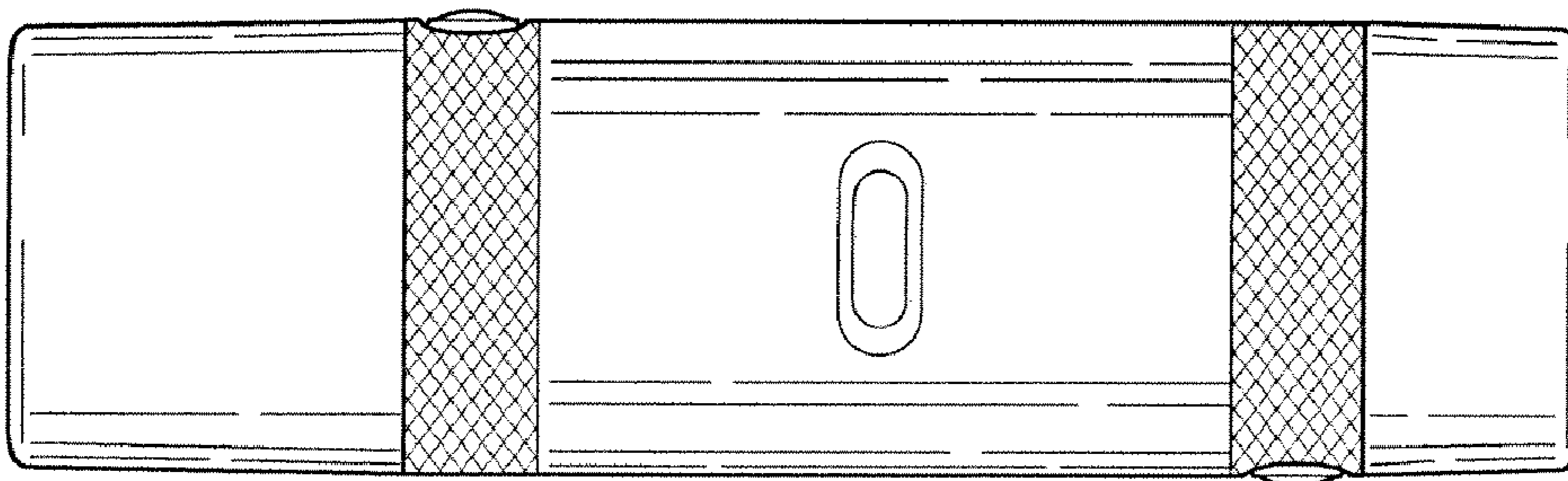
**FIG. 16**



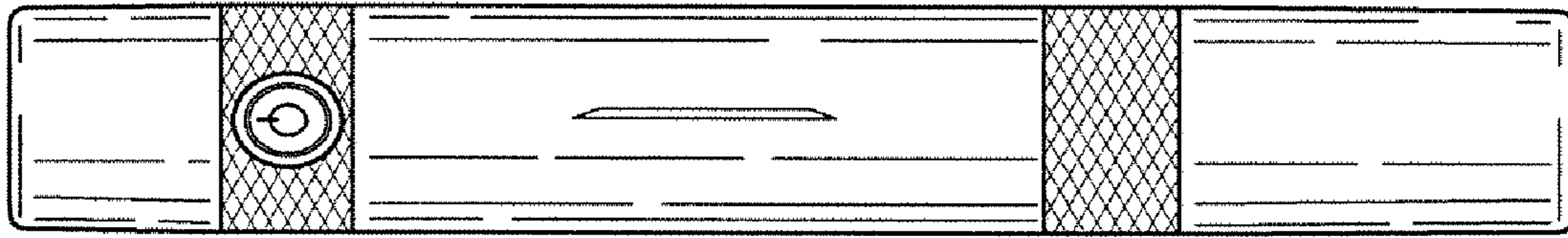
**FIG. 17**



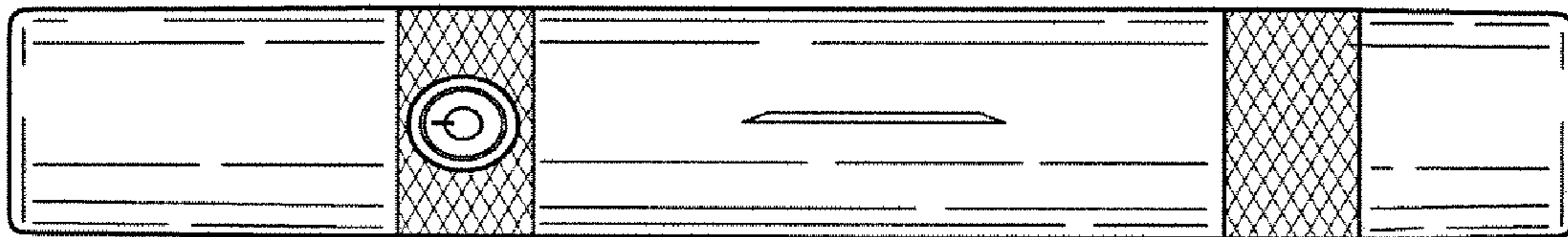
**FIG. 18**



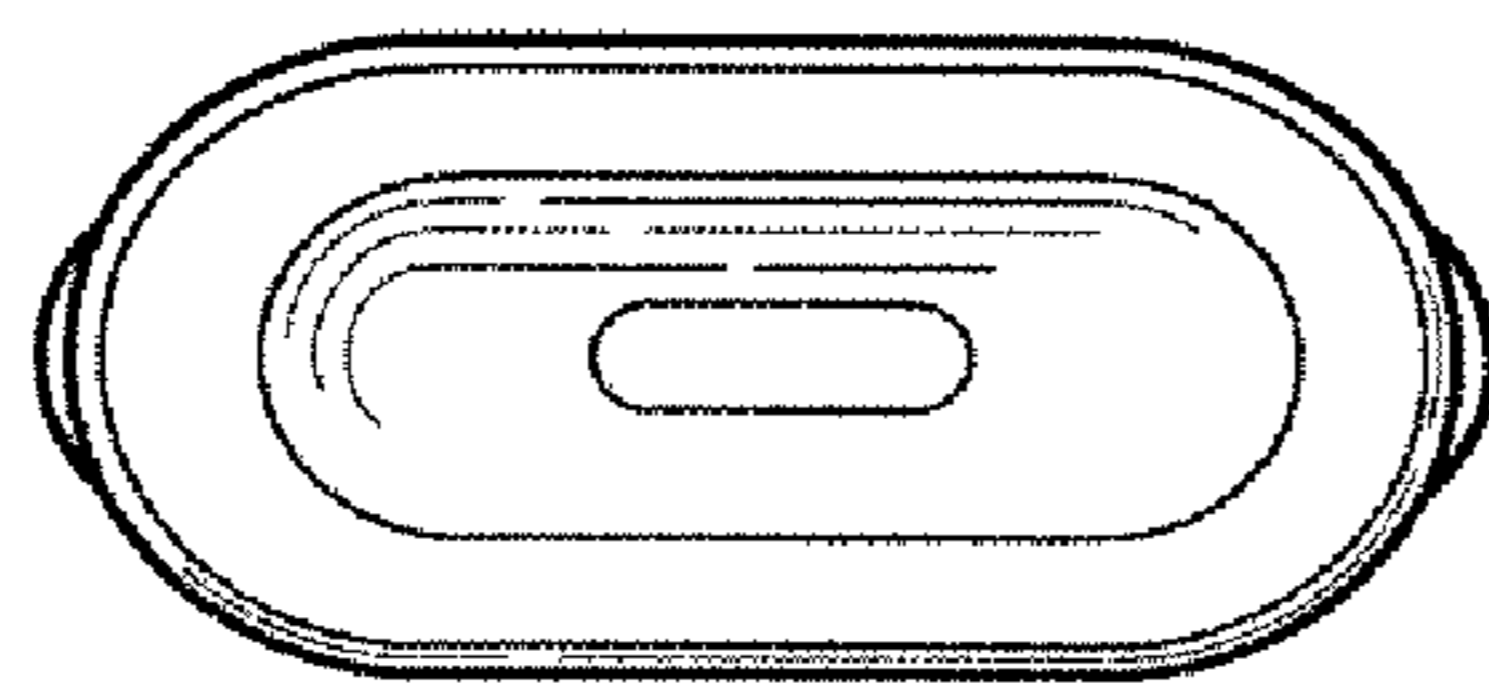
**FIG. 19**



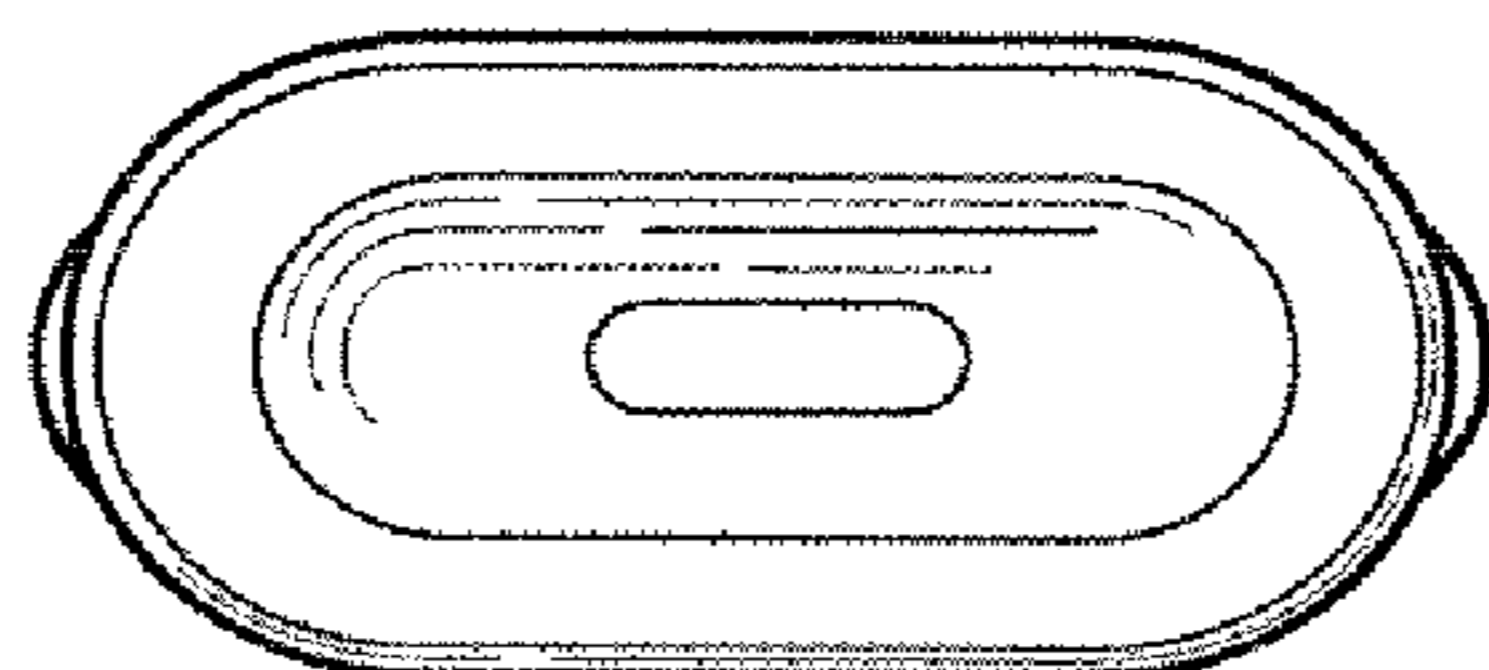
**FIG. 20**



**FIG. 21**

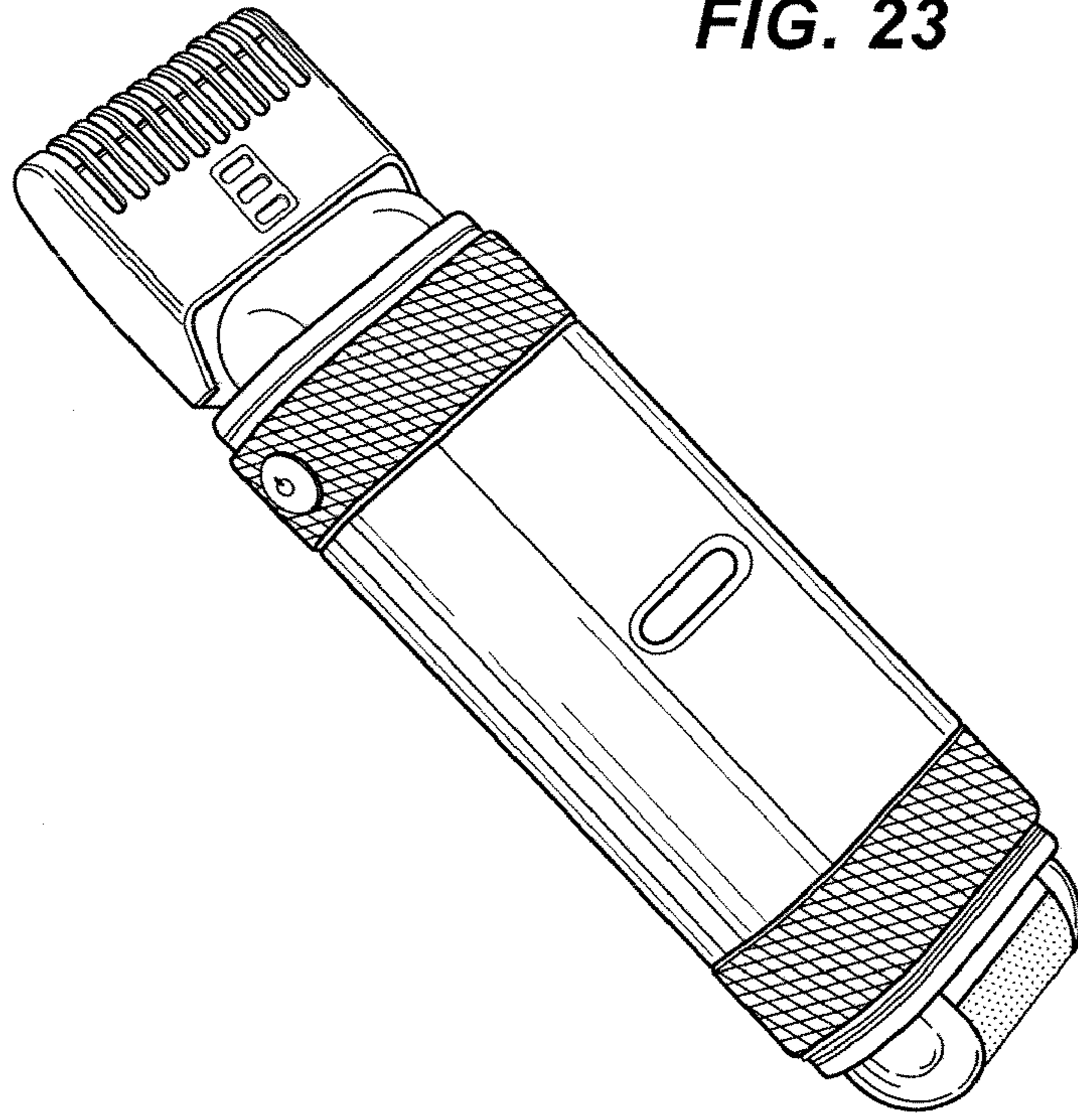


**FIG. 22**

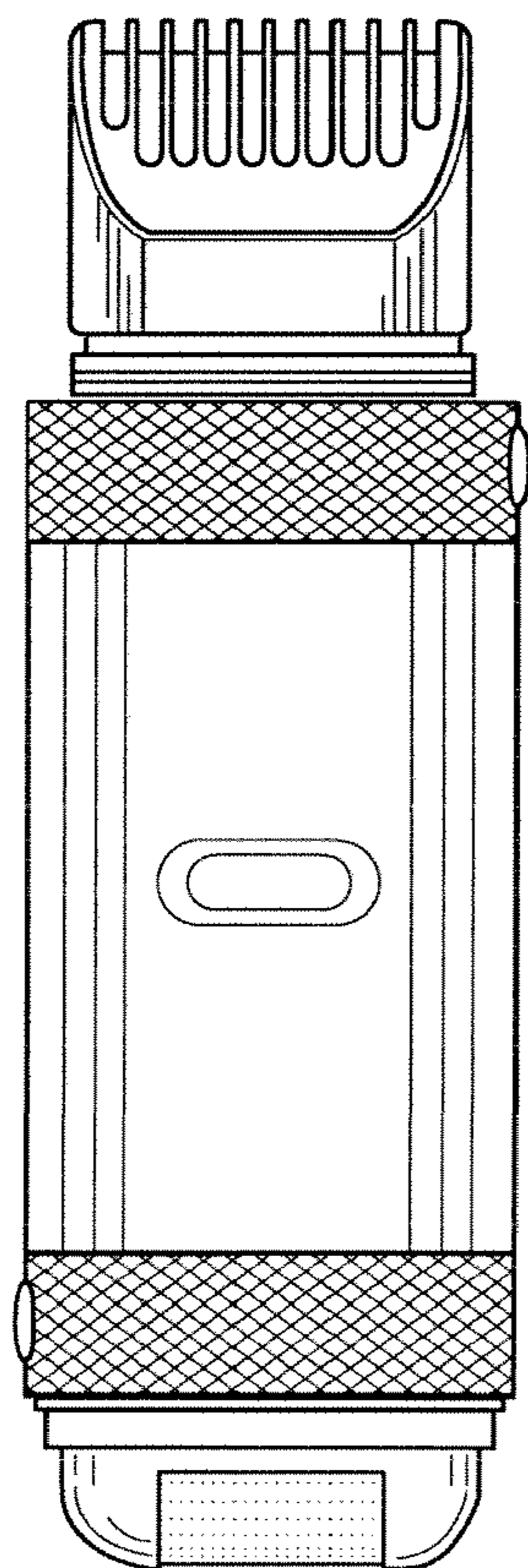




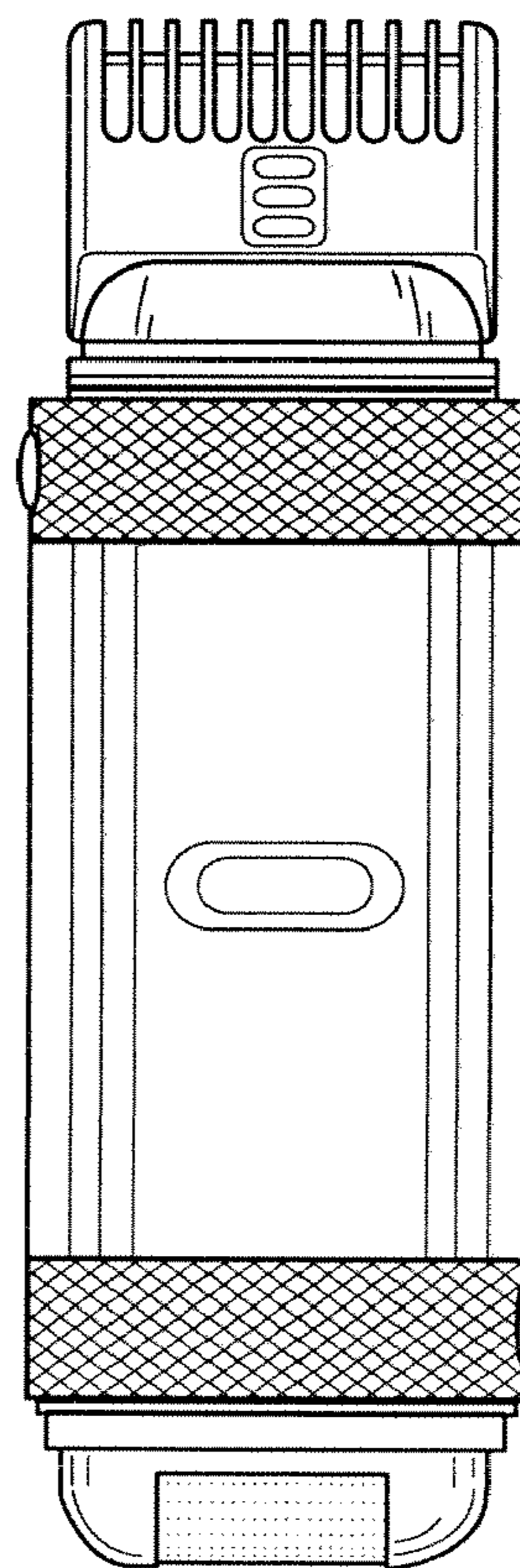
**FIG. 23**



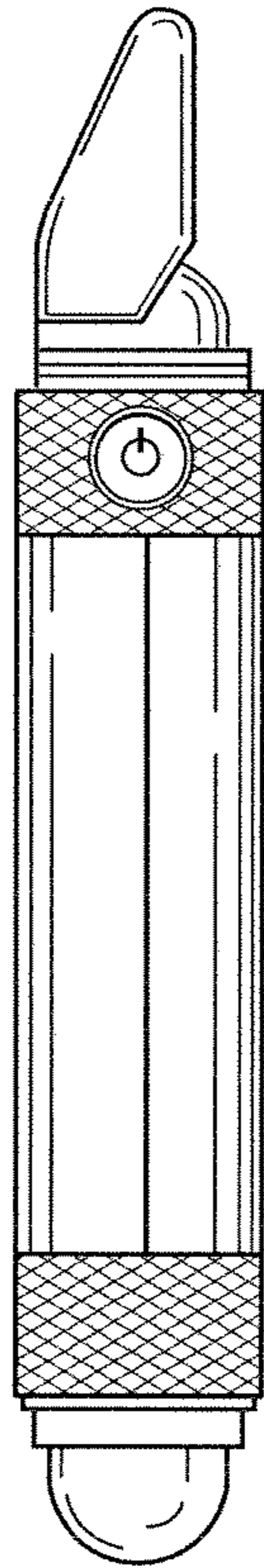
**FIG. 24**



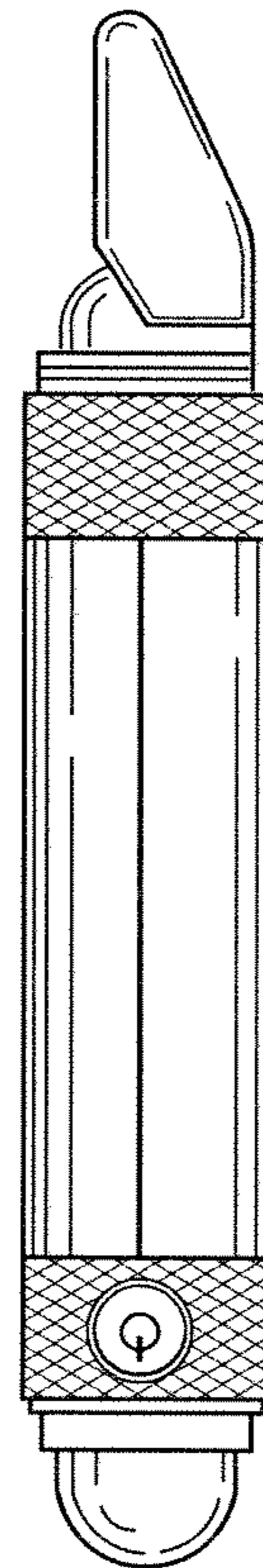
**FIG. 25**



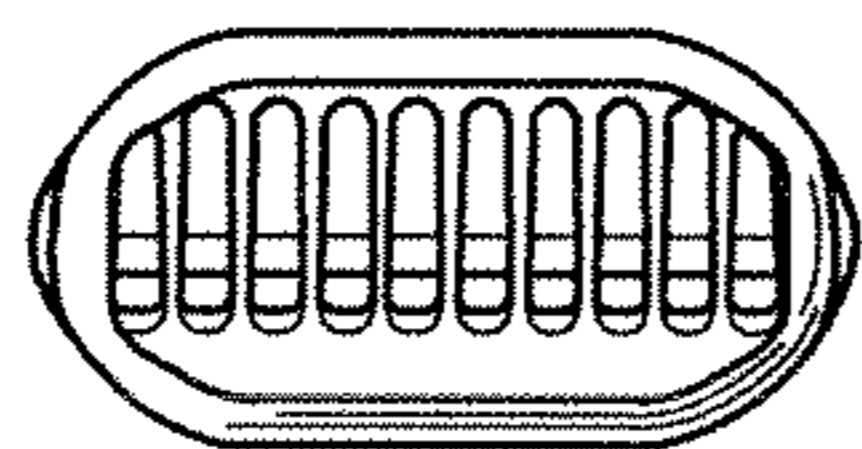
**FIG. 26**



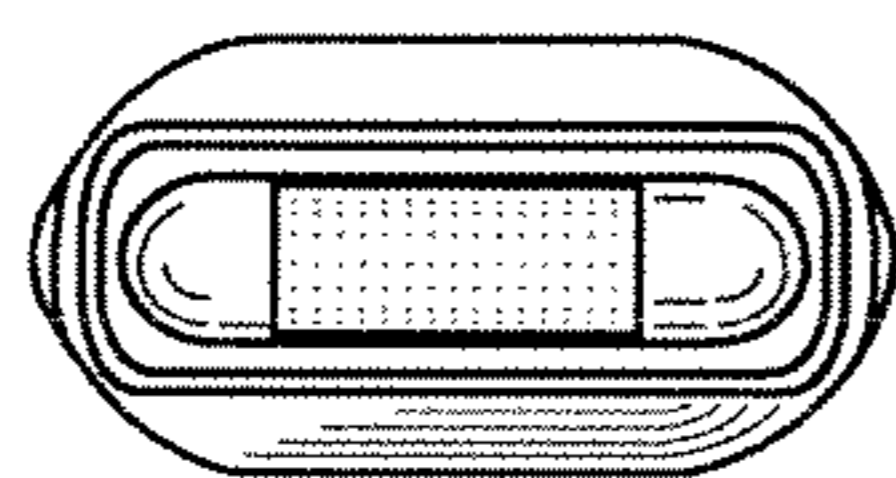
**FIG. 27**



**FIG. 28**



**FIG. 29**



**FIG. 30**

