

US00D560299S

(12) **United States Design Patent**
Bucher et al.

(10) **Patent No.:** **US D560,299 S**
(45) **Date of Patent:** **** Jan. 22, 2008**

(54) **COMBINED LIGHT SHADE AND CANOPY**

D484,233 S 12/2003 Bucher et al. D23/377
D485,346 S 1/2004 Bucher et al. D23/377
D485,347 S 1/2004 Bucher et al. D23/377

(75) Inventors: **John C. Bucher**, Hillsboro Beach, FL
(US); **Dale Tiffany**, La Mirada, CA
(US); **Tien S. Lowe**, Pembroke Pines,
FL (US)

(73) Assignee: **King Of Fans, Inc.**, Ft. Lauderdale, FL
(US)

(**) Term: **14 Years**

(21) Appl. No.: **29/234,373**

(22) Filed: **Jul. 18, 2005**

(51) **LOC (8) Cl.** **26-05**

(52) **U.S. Cl.** **D26/59**

(58) **Field of Classification Search** D23/377,
D23/379, 385, 411, 413; D26/59, 51, 81-86,
D26/88, 72; 416/5

See application file for complete search history.

(56) **References Cited**

U.S. PATENT DOCUMENTS

D360,940 S	*	8/1995	Collmar	D23/377
D364,224 S		11/1995	Wang	D23/377
D371,838 S		7/1996	Davis, Jr. et al.	D23/411
D378,404 S		3/1997	Jaspers-Fayer	D23/377
D383,528 S	*	9/1997	Collmar	D23/377
D389,943 S	*	1/1998	Miranda	D26/88
D392,033 S	*	3/1998	Jaspers-Fayer	D23/377
D402,026 S		12/1998	Chuang et al.	D23/377
D408,518 S		4/1999	Liu	D23/377
D412,571 S		8/1999	Lee	D23/377
D414,856 S		10/1999	Zuege	D23/377
D421,799 S		3/2000	Zuege	D23/411
D422,072 S		3/2000	Blateri	D23/377

OTHER PUBLICATIONS

52 In. Dale Tiffany Moresby, [online] The Home Depot—
Lighting and fans, Internet Catalog #181201, Model # 08264
[Retrieved on Jul. 15, 2005] 1 page, Retrieved from: http://www.homedepot.com/pre180/HDUS/EN_US/shop_cart/pg_print_product.jsp?CNTT...

* cited by examiner

Primary Examiner—Lisa Lichtenstein

(74) *Attorney, Agent, or Firm*—Brian S. Steinberger; Law
Offices of Brian S. Steinberger, P.A.

(57) **CLAIM**

The ornamental design for a combined light shade and
canopy, as shown and described.

DESCRIPTION

FIG. 1 is a perspective front side bottom view of a combined
light shade and canopy.

FIG. 2 is a perspective front side top view thereof.

FIG. 3 is a front side view thereof.

FIG. 4 is a left side view thereof.

FIG. 5 is a rear side view thereof.

FIG. 6 is a right side view thereof.

FIG. 7 is a bottom view thereof; and,

FIG. 8 is a top view thereof.

The broken line showing of the ceiling canopy, vertical
support rod, internal light fixture, internal cone and multi
part tip in FIGS. 1-8 are for illustrative purposes only and
forms no part of the claimed design.

1 Claim, 8 Drawing Sheets

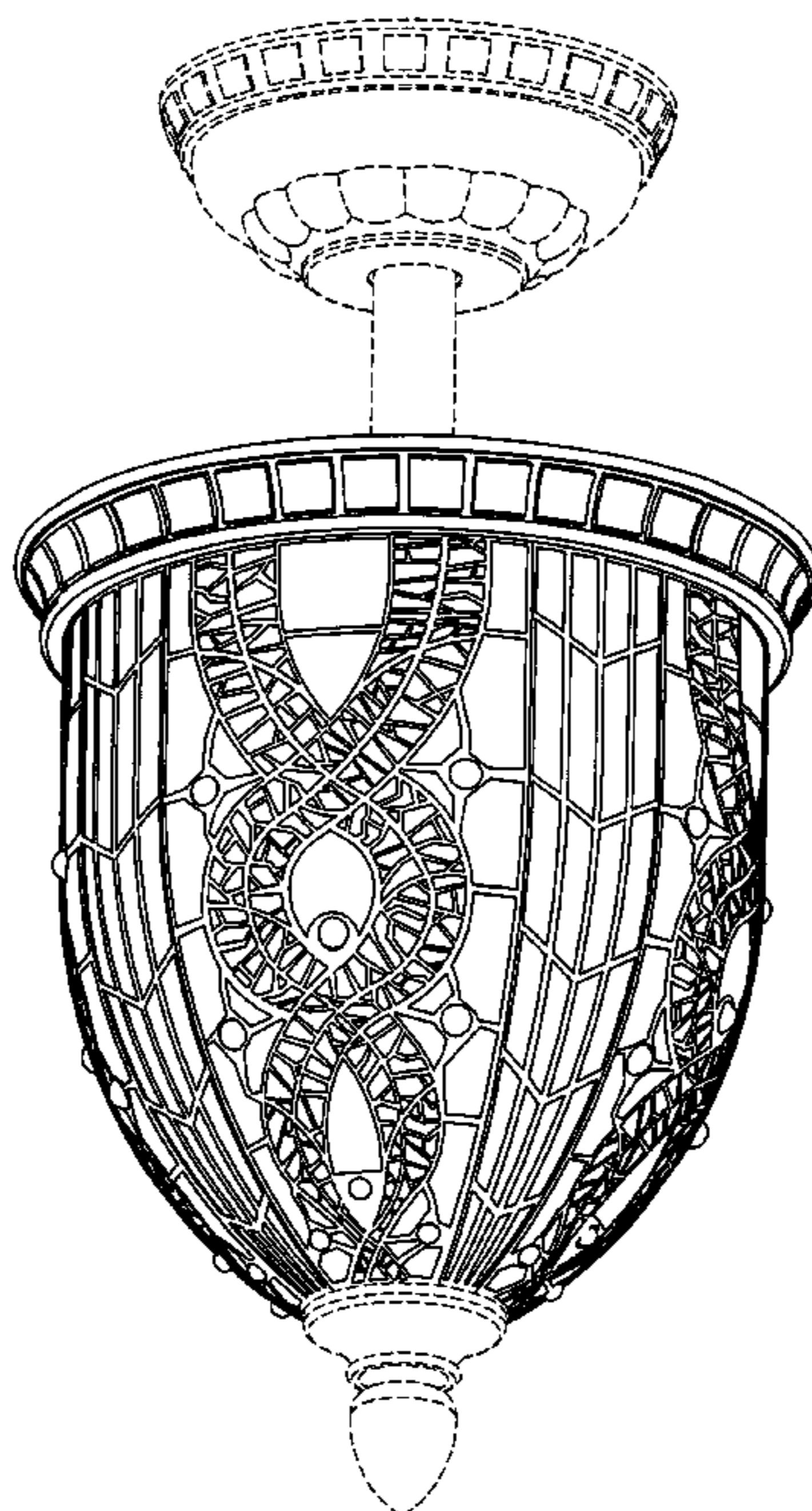

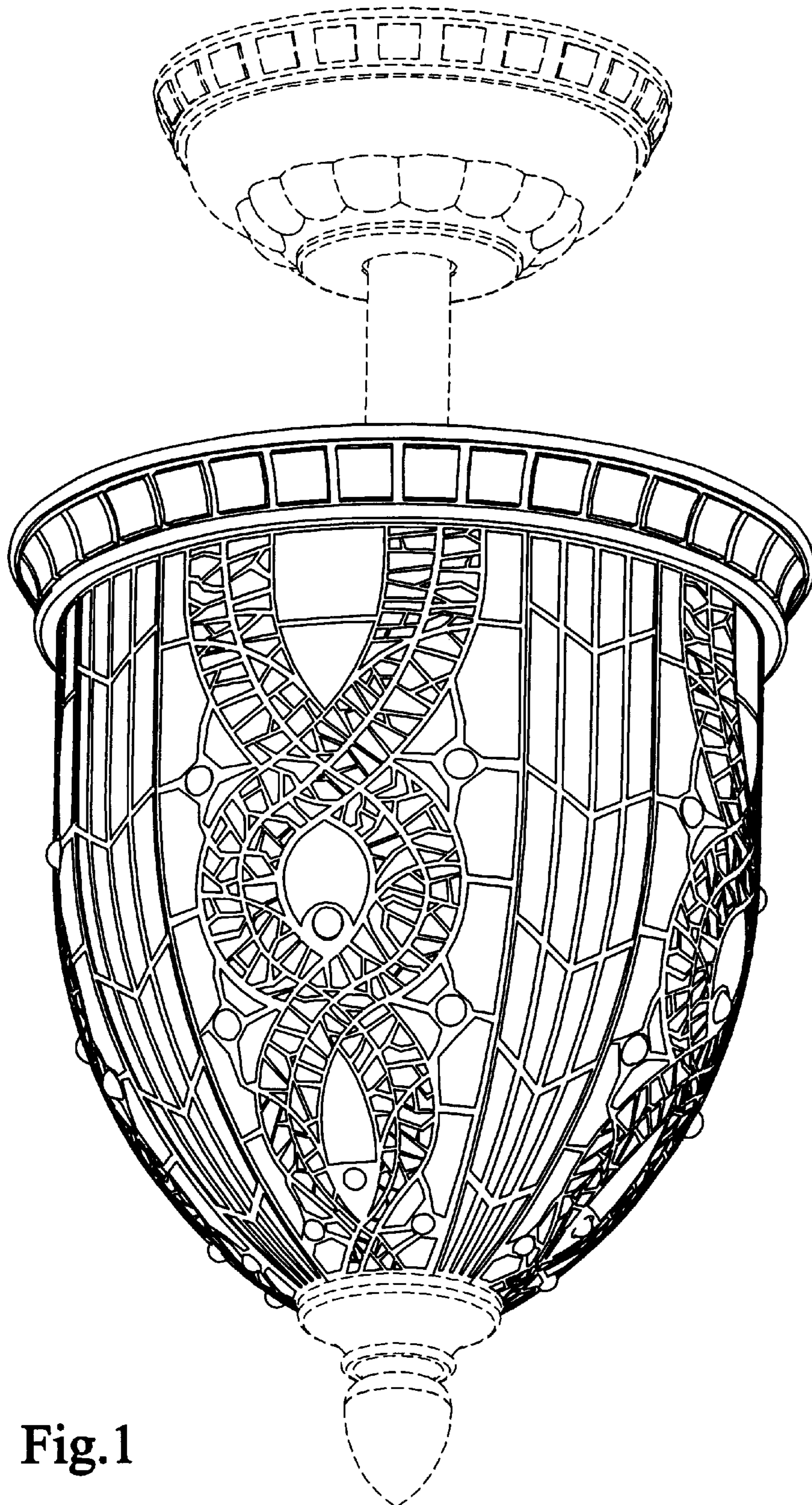

Fig. 1

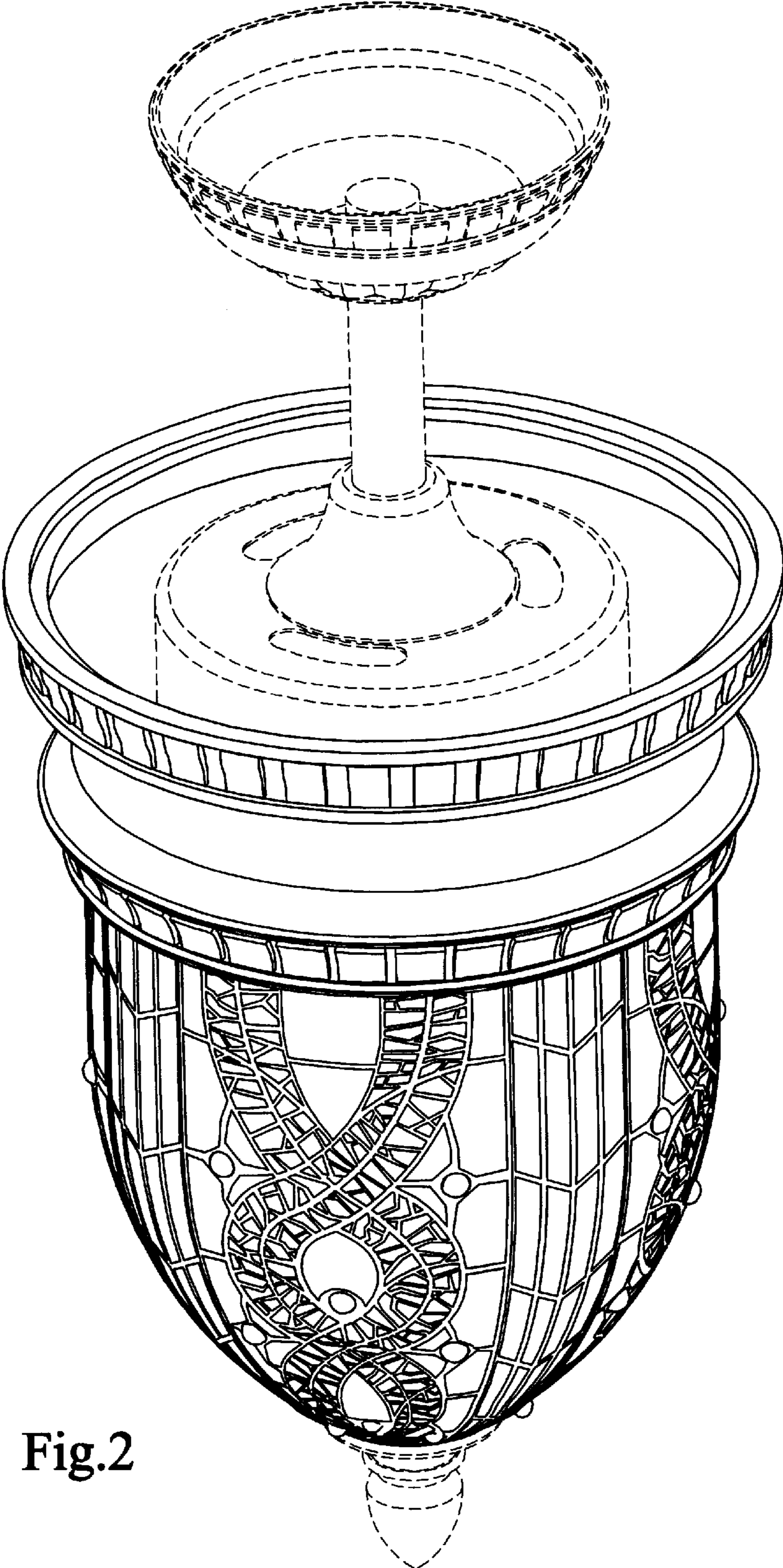

Fig. 2

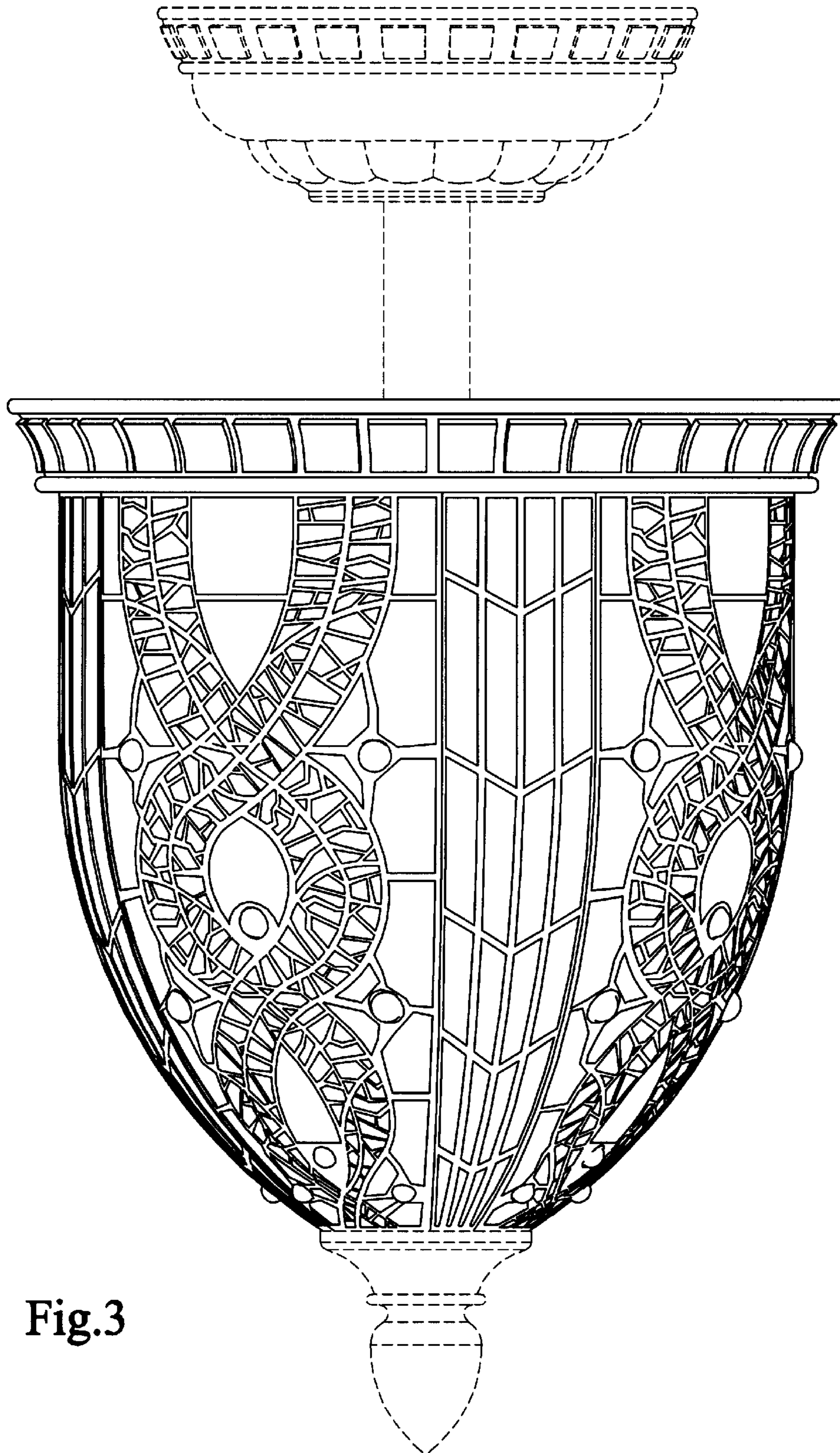

Fig.3

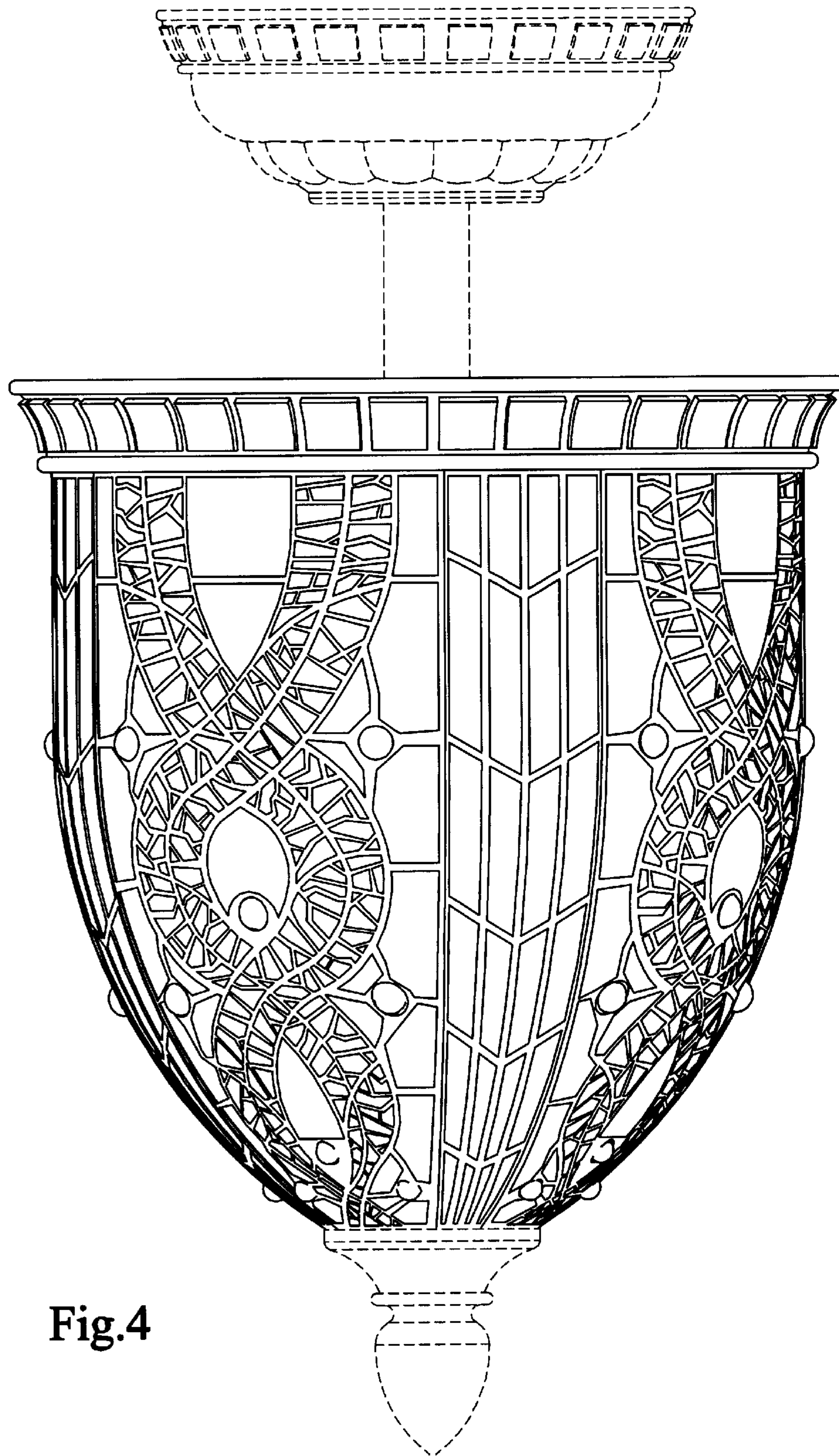

Fig.4

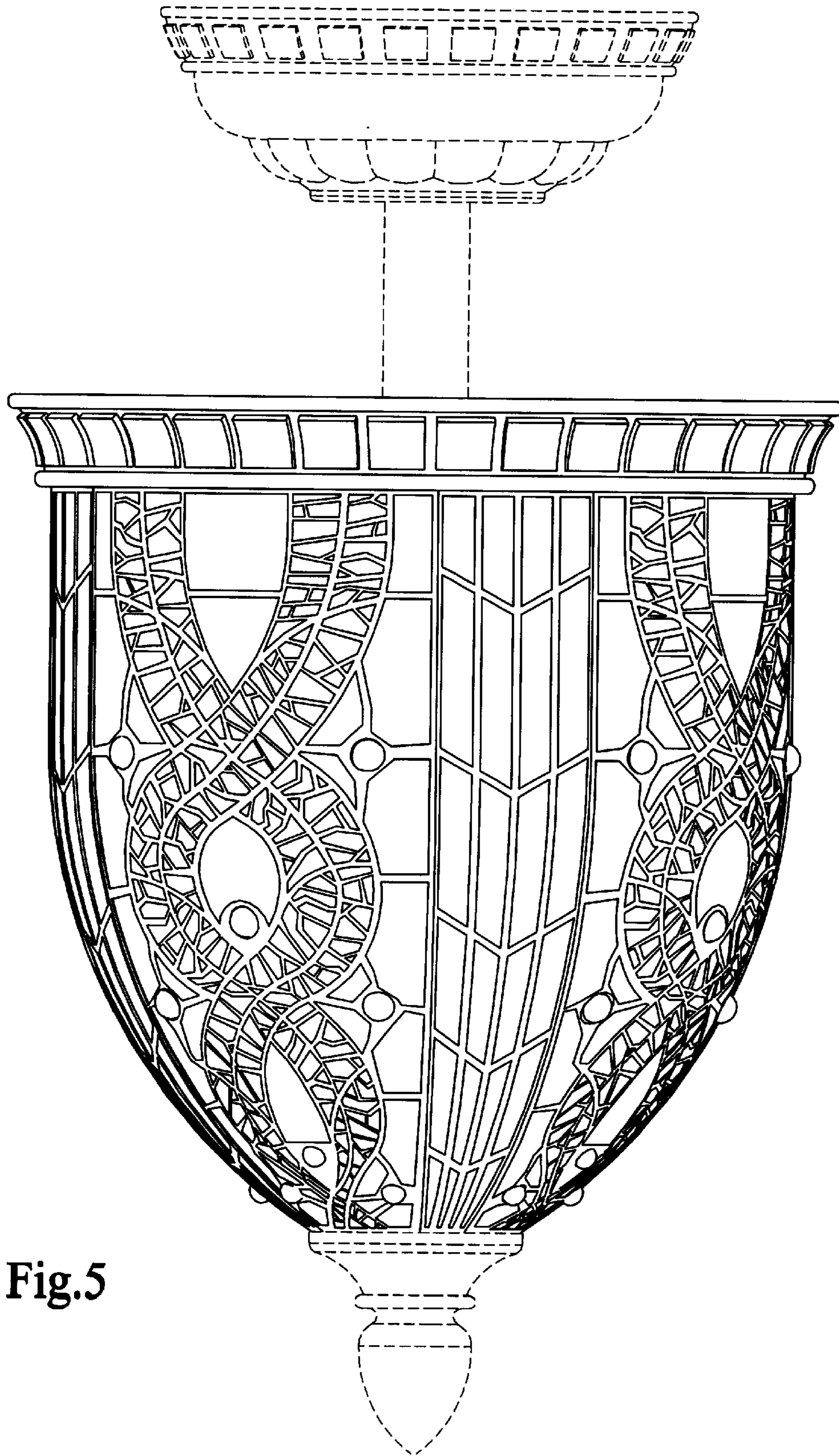

Fig.5

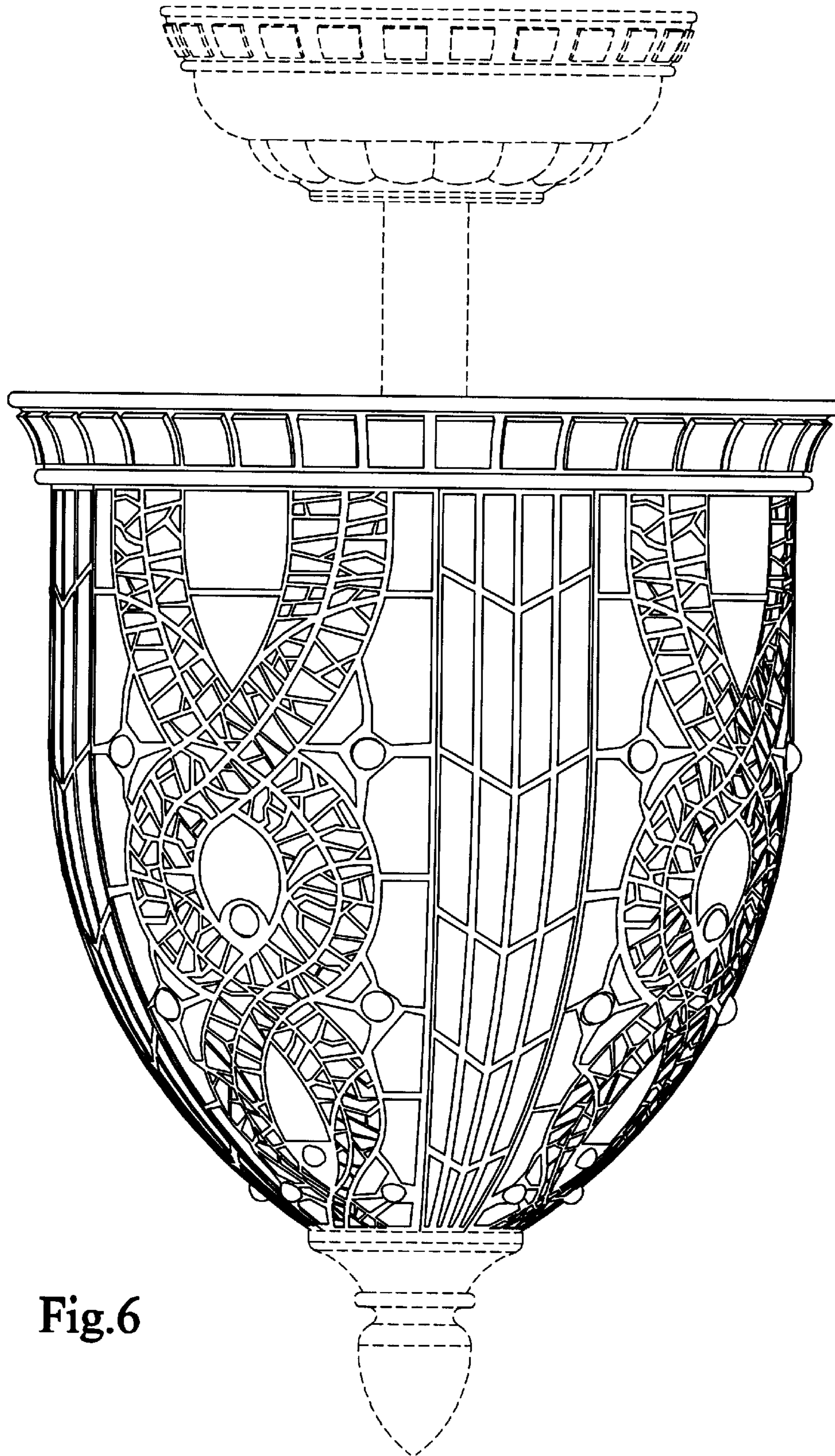

Fig.6

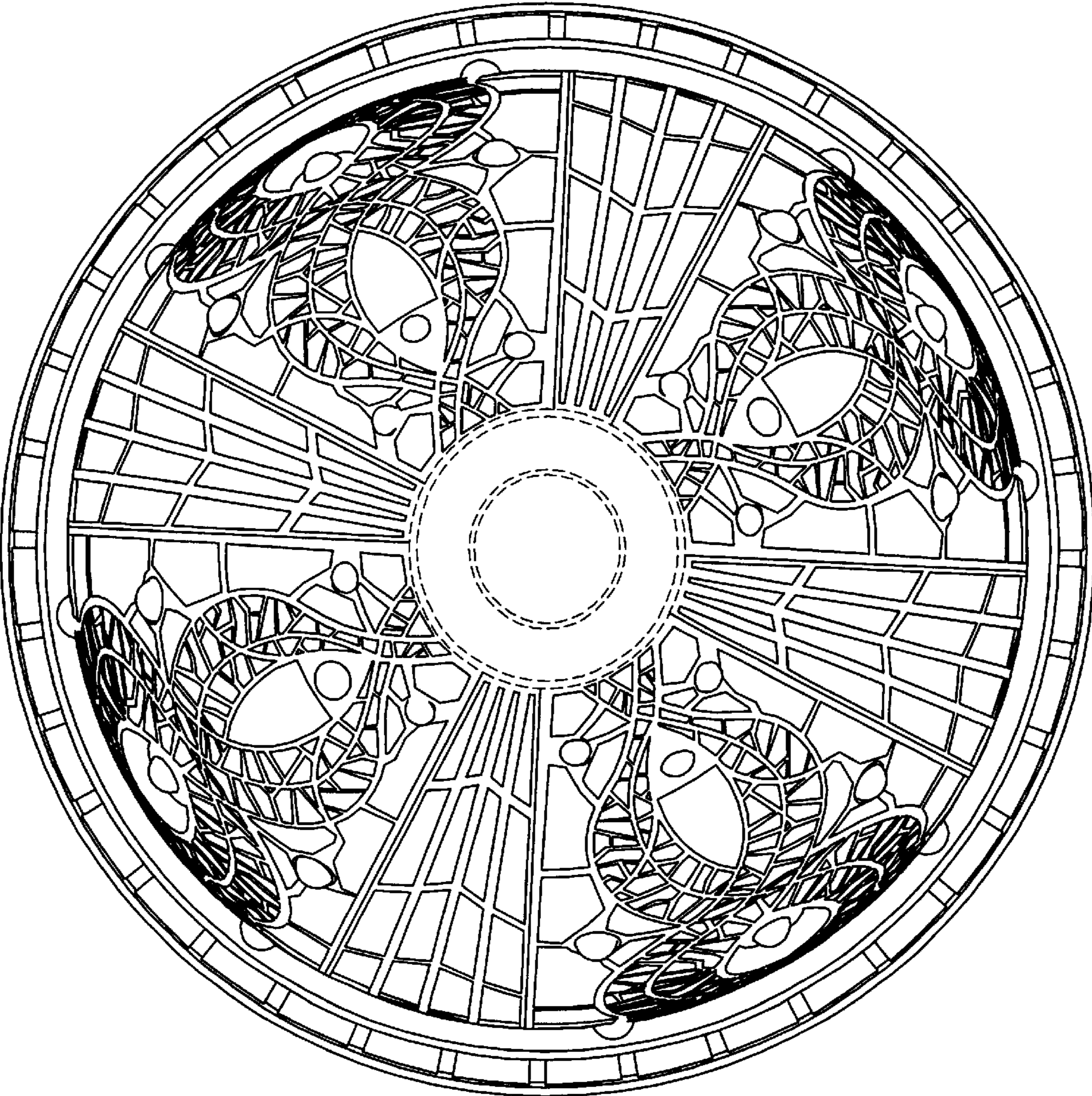

Fig.7

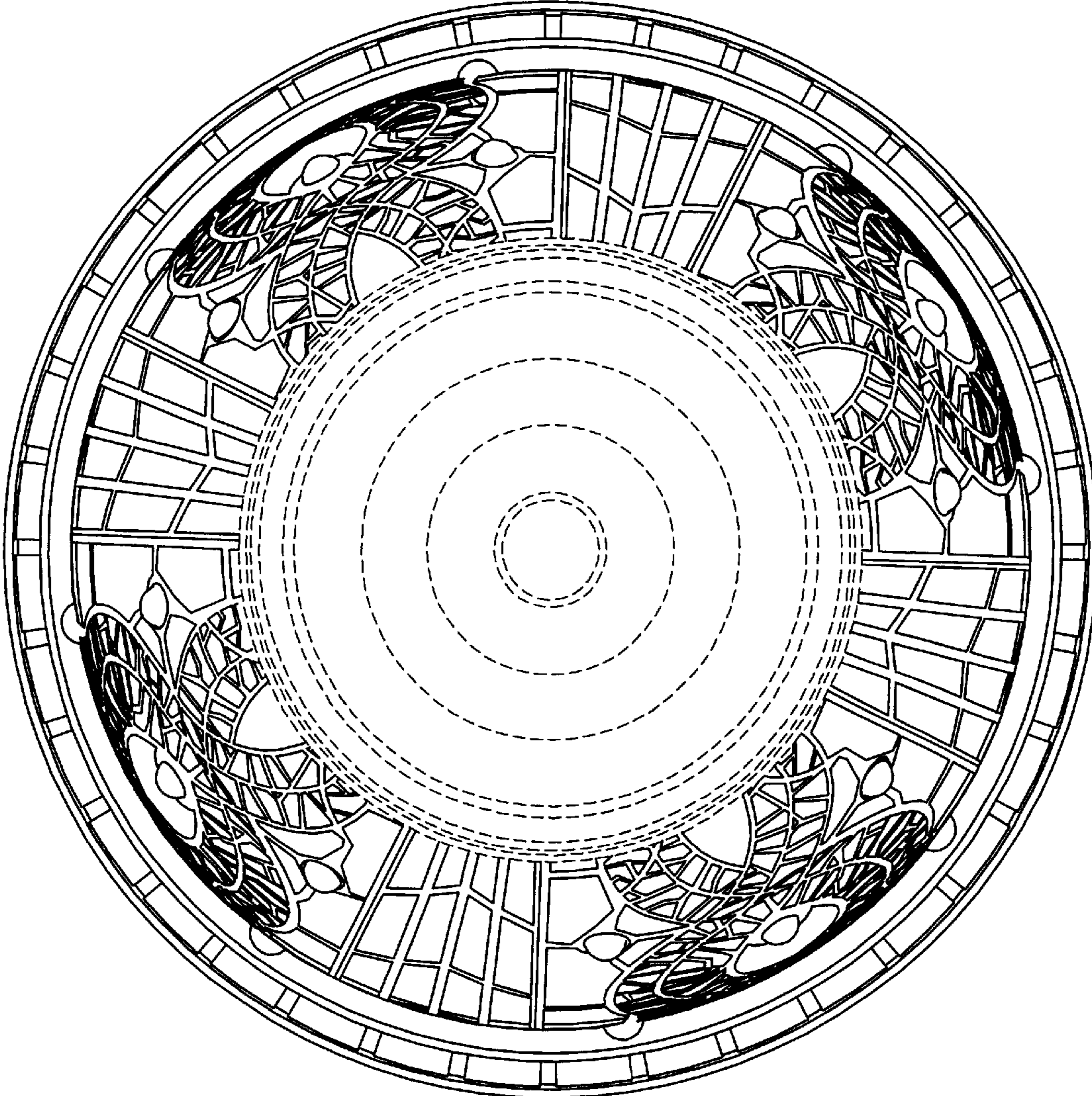

Fig.8