



US00D560259S

(12) **United States Design Patent**
Heggdal

(10) **Patent No.:** **US D560,259 S**
(45) **Date of Patent:** **** Jan. 22, 2008**

(54) **KICK AND BALANCE TRAINER**
(75) Inventor: **Kjell Aasen Heggdal**, Ikornnes (NO)
(73) Assignee: **Svan AB**, Halmstad (SE)
(**) Term: **14 Years**
(21) Appl. No.: **29/227,971**
(22) Filed: **Apr. 19, 2005**

(30) **Foreign Application Priority Data**
Sep. 15, 2004 (EM) 000226469
(51) **LOC (8) Cl.** **21-02**
(52) **U.S. Cl.** **D21/690**
(58) **Field of Classification Search** D21/662,
D21/690, 686, 419, 423, 426; D6/361, 375,
D6/502; 482/132, 142
See application file for complete search history.

(56) **References Cited**
U.S. PATENT DOCUMENTS
D194,498 S * 2/1963 Miller D6/361
D217,449 S * 5/1970 Mayer D6/361
D230,444 S * 2/1974 Kogof et al. D6/361
D236,861 S * 9/1975 Conrad et al. D6/361
D280,054 S * 8/1985 Pedersen D6/375
D295,991 S * 5/1988 Hanna et al. D21/423
D301,495 S * 6/1989 Riggs D21/688
D385,710 S * 11/1997 Beck D6/374
D428,454 S * 7/2000 Fischer et al. D21/662
D490,618 S * 6/2004 Green et al. D6/361

D494,374 S * 8/2004 Cagle D6/361
D526,498 S * 8/2006 Jimenez M. et al. D6/361

FOREIGN PATENT DOCUMENTS

EP 000226469 12/2004

* cited by examiner

Primary Examiner—Philip S. Hyder

(57) **CLAIM**

The ornamental design for a kick and balance trainer, as shown and described.

DESCRIPTION

FIG. 1 is a perspective rear view of the kick and balance trainer of the present invention;
FIG. 2 is a perspective front view of the kick and balance trainer shown in FIG. 1;
FIG. 3 is a top view of the kick and balance trainer shown in FIG. 1;
FIG. 4 is a left side view of the kick and balance trainer shown in FIG. 1;
FIG. 5 is a rear view of the kick and balance trainer shown in FIG. 1; and,
FIG. 6 is a front view of the kick and balance trainer shown in FIG. 1.

The broken line showing of the wheels is included for the purpose of illustrating environmental structure and forms no part of the claimed design.

1 Claim, 3 Drawing Sheets

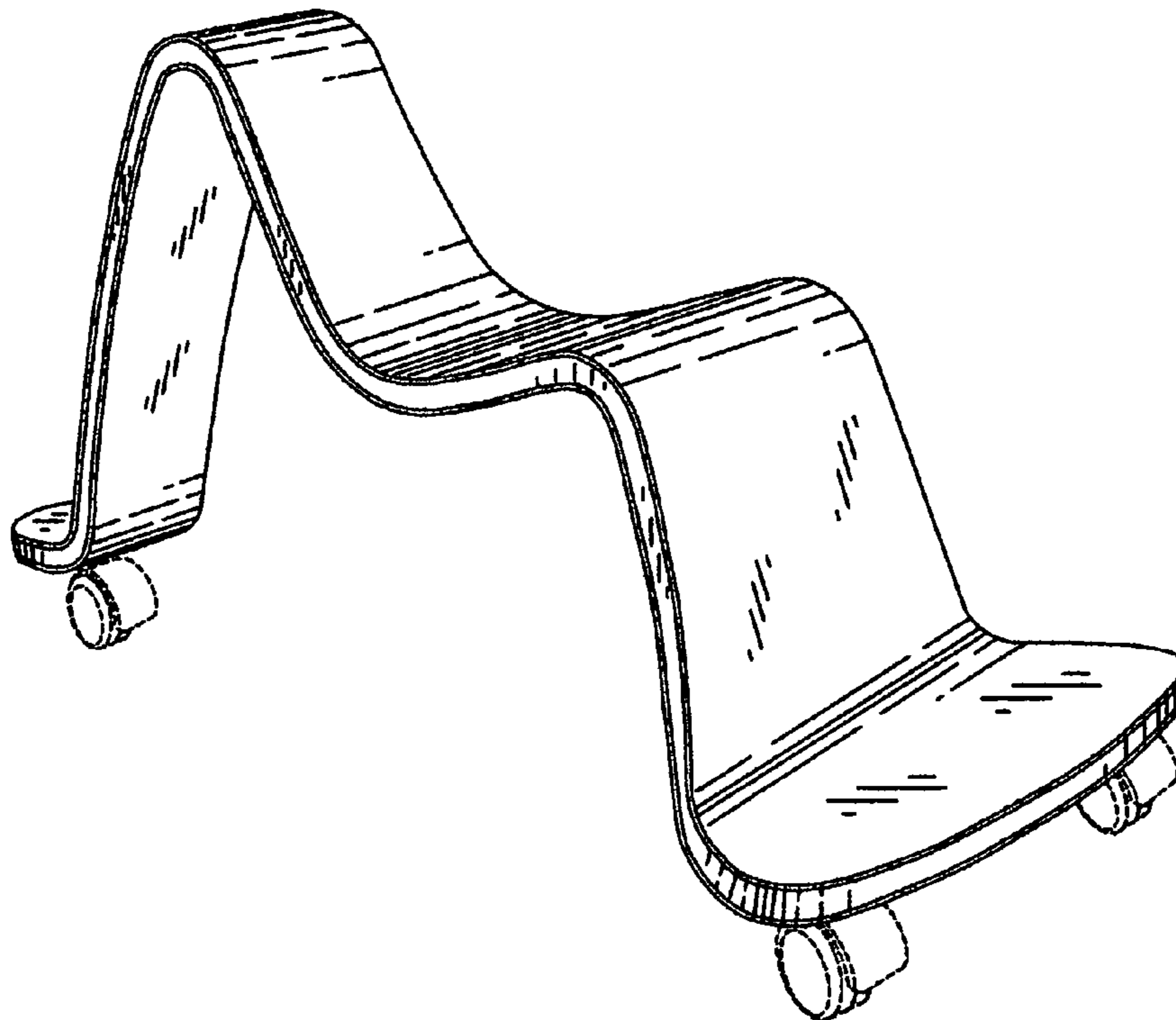

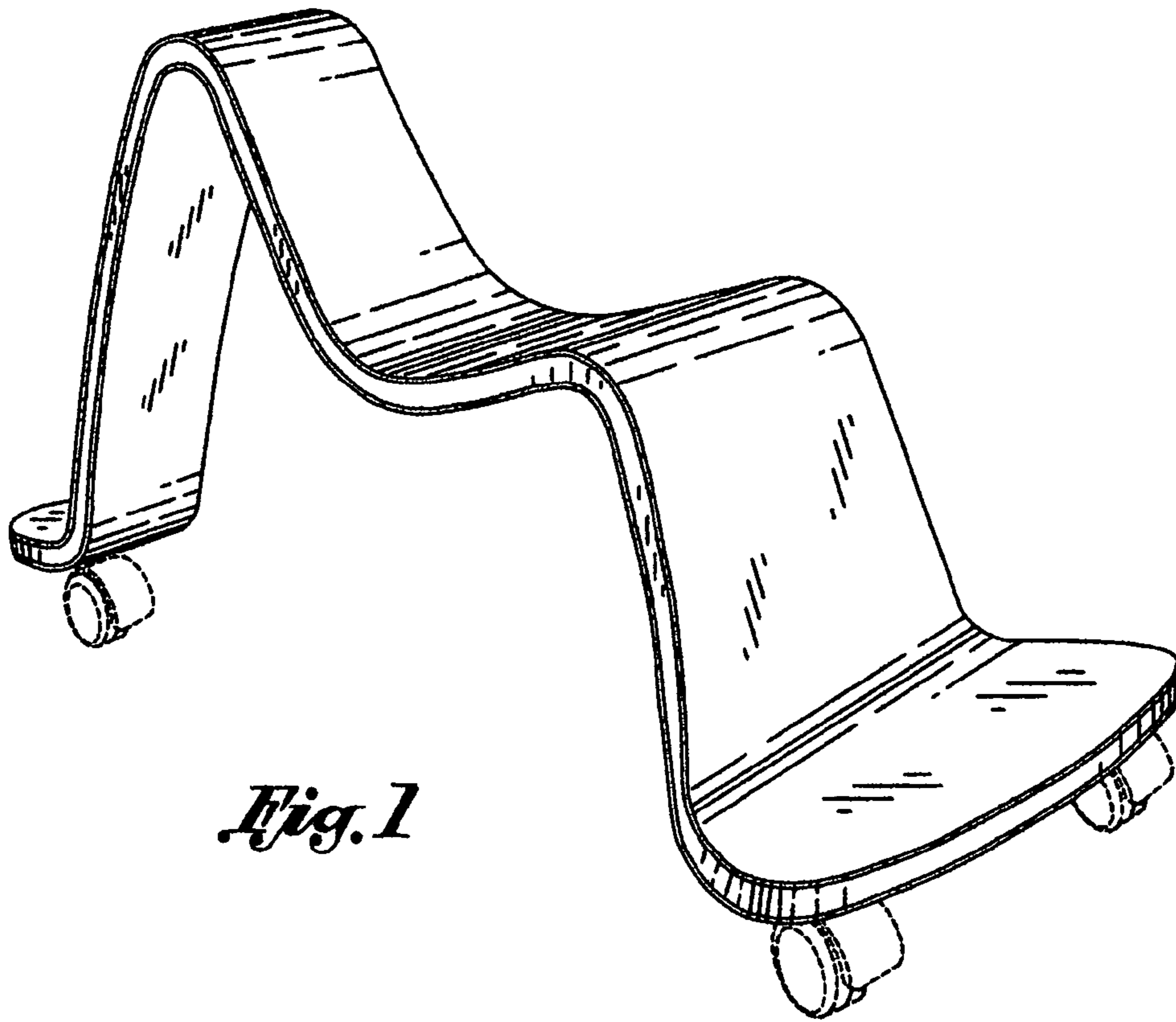

Fig. 1

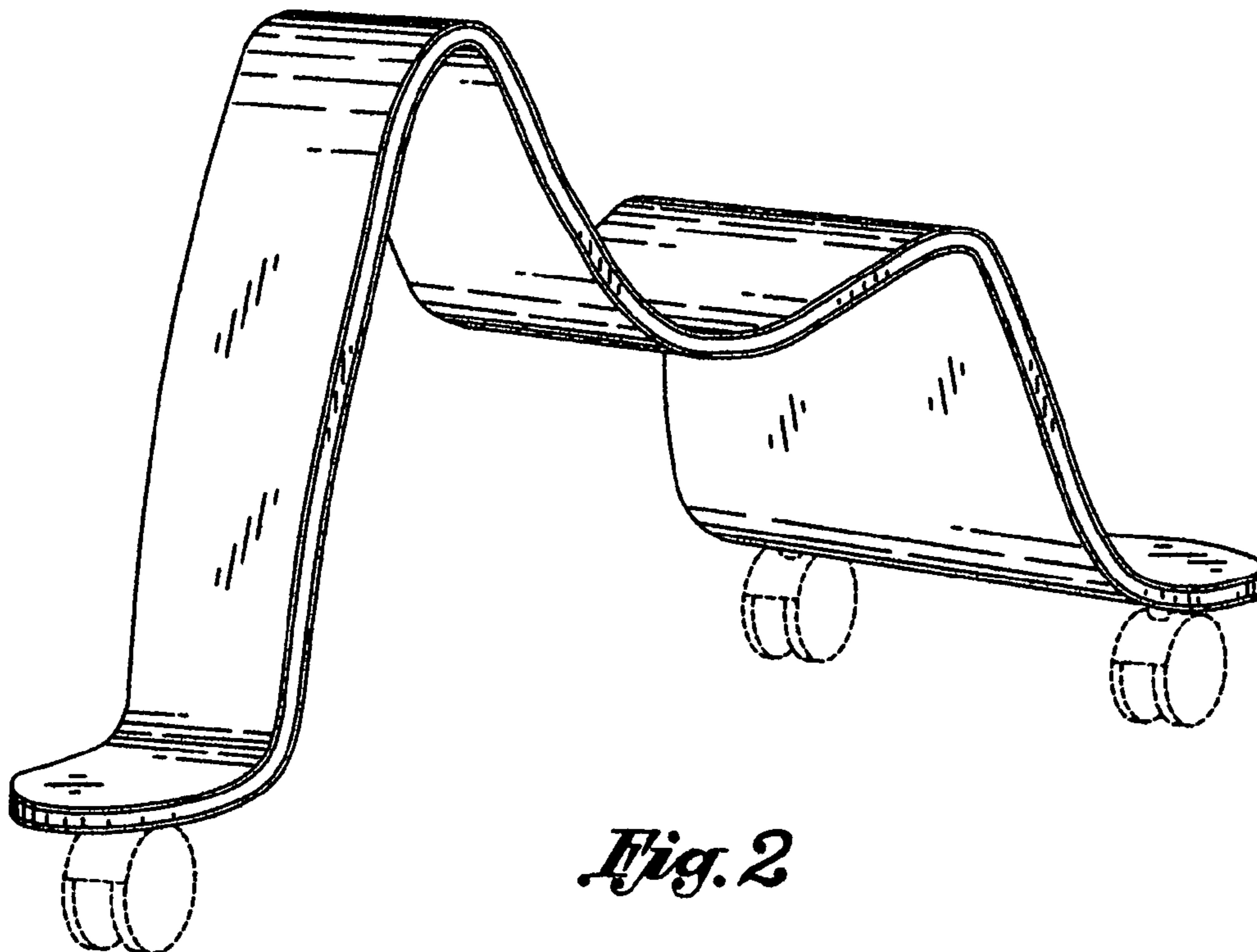

Fig. 2

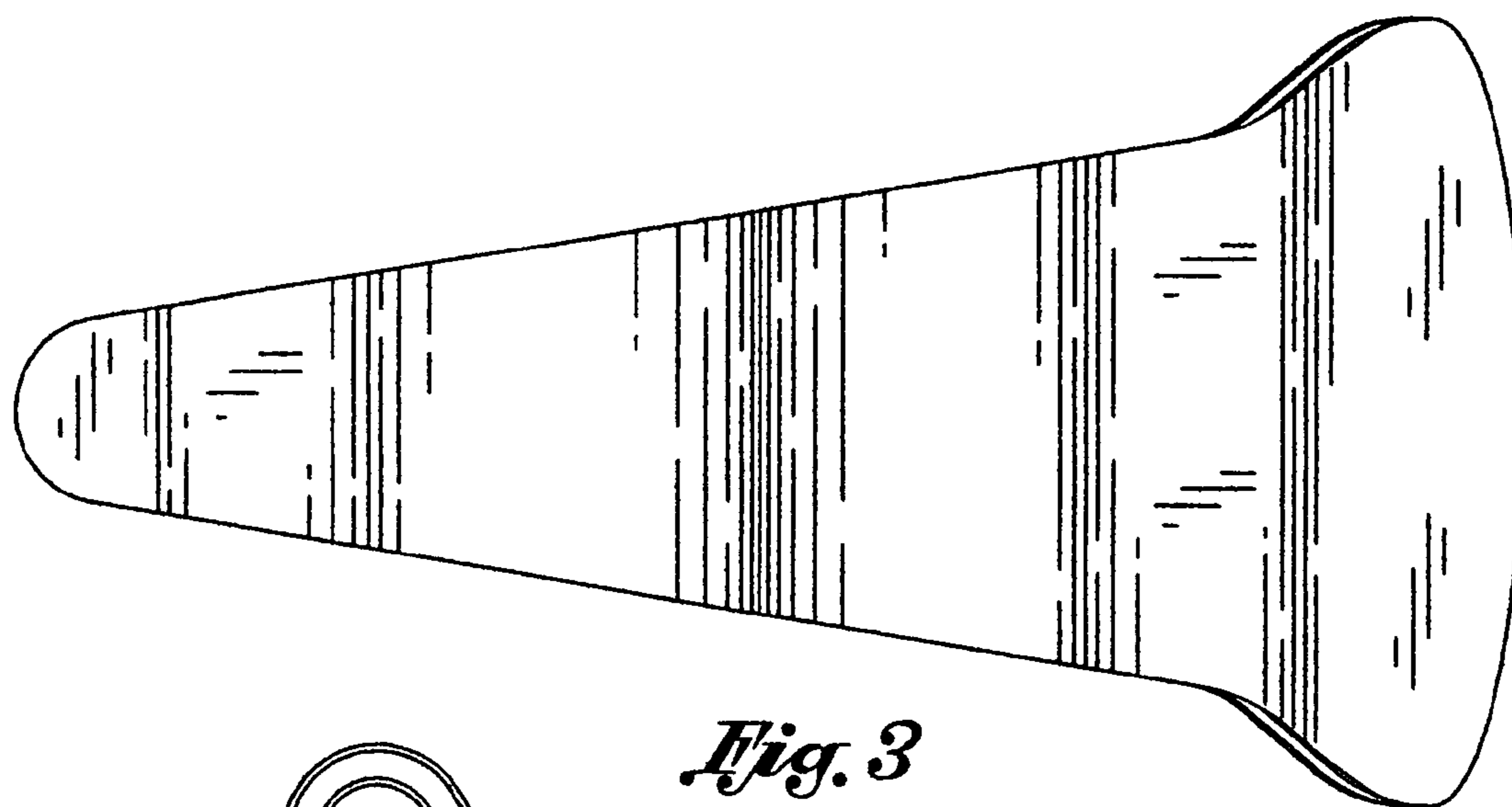

Fig. 3

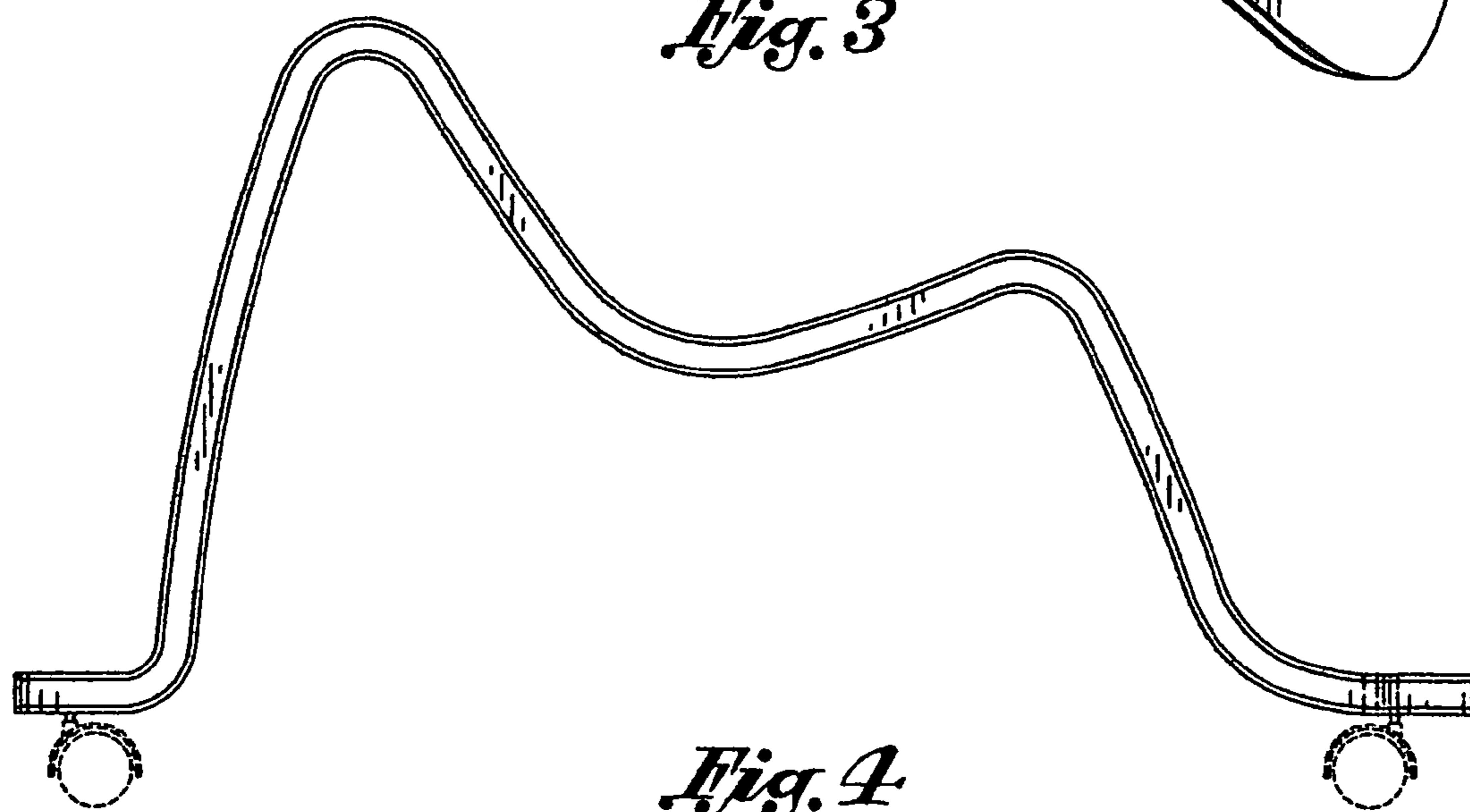

Fig. 4

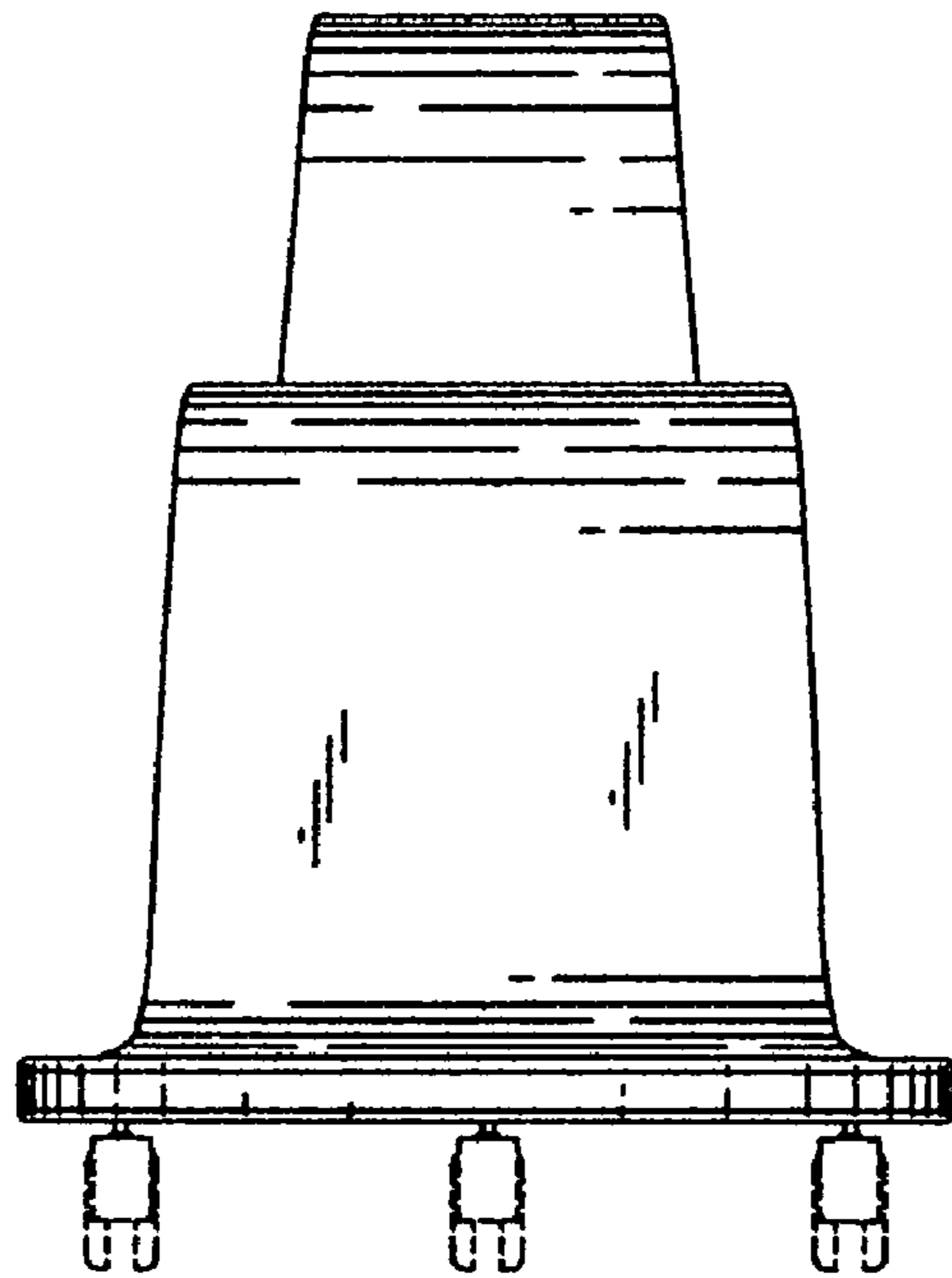

Fig. 5

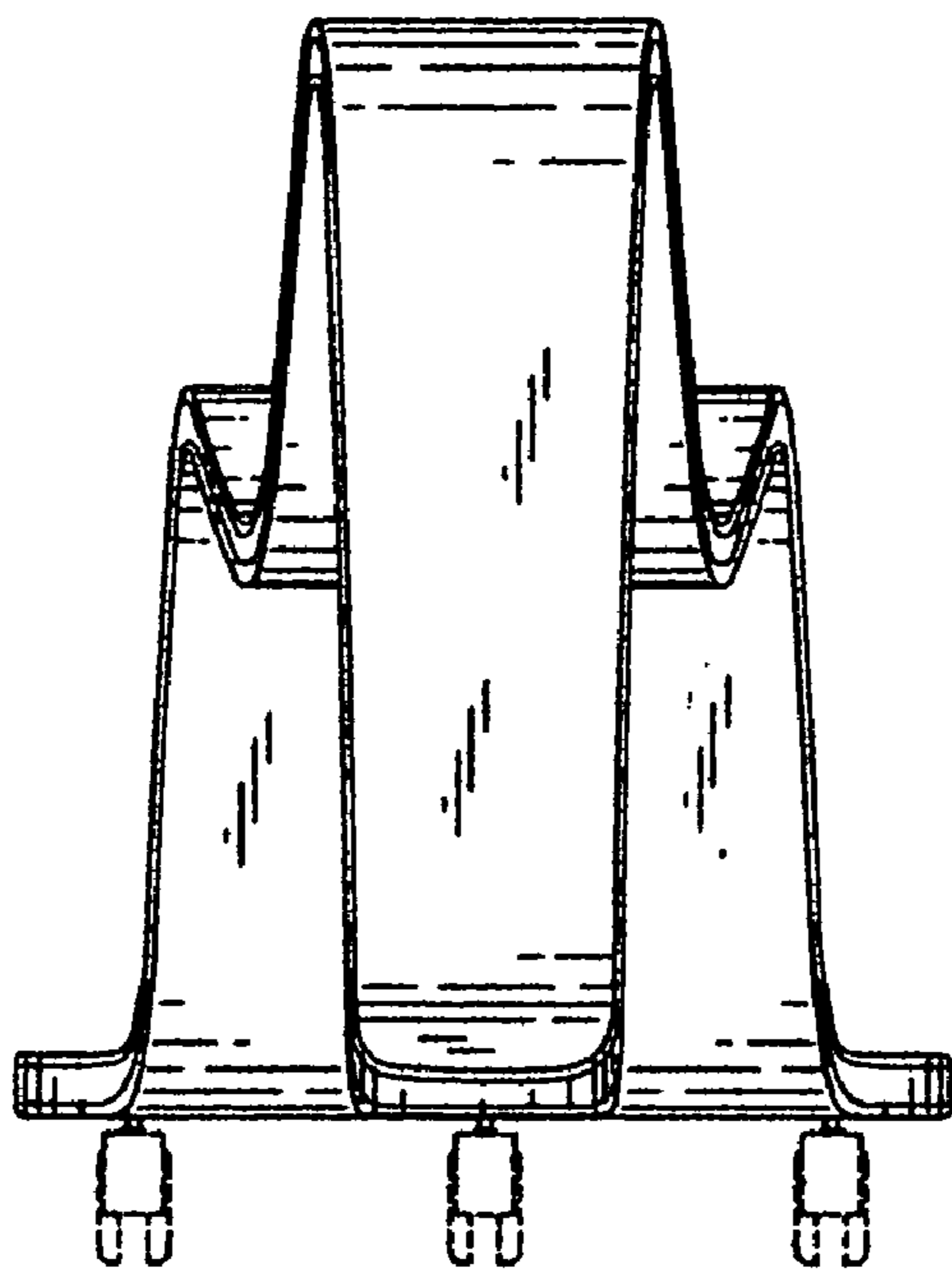

Fig. 6