



US00D560235S

(12) **United States Design Patent**
McDaniel

(10) **Patent No.:** **US D560,235 S**

(45) **Date of Patent:** **** *Jan. 22, 2008**

(54) **SLIDING TAPERED DOVETAIL AND FIXED HALF-BLIND DOVETAIL TEMPLATE**

(75) Inventor: **Steven D. McDaniel**, Humboldt, TN (US)

(73) Assignee: **Black & Decker Corporation**, Newark, DE (US)

(**) Term: **14 Years**

(21) Appl. No.: **29/264,907**

(22) Filed: **Aug. 22, 2006**

(51) **LOC (8) Cl.** **15-09**

(52) **U.S. Cl.** **D15/140**

(58) **Field of Classification Search** D8/71;
D15/140; 33/197, 561; 144/41, 85-89,
144/221, 144.5; 269/41, 221

See application file for complete search history.

(56) **References Cited**

U.S. PATENT DOCUMENTS

18,838 A	12/1857	Babbs et al.
266,042 A	10/1882	Merz
475,544 A	5/1892	Dobbie
478,544 A	7/1892	Cordesman et al.
610,272 A	9/1898	Lindwall
1,262,743 A	4/1918	Bronson
1,432,121 A	10/1922	Prickett
1,466,312 A	8/1923	Morcom
1,483,966 A	2/1924	Collins
1,532,467 A	4/1925	Barnett
1,670,074 A	5/1928	Mathez
1,679,074 A	7/1928	Carter
1,751,816 A	3/1930	Hunter
1,841,043 A	1/1932	Moore
1,863,032 A	6/1932	Seelinger
2,036,348 A	4/1936	Miller
2,080,859 A	5/1937	Drapak et al.
2,260,784 A	10/1941	Morton

2,299,602 A	10/1942	Teague
2,607,375 A	9/1952	Gillespie et al.
2,651,847 A	9/1953	Sacrey
2,660,803 A	12/1953	Sacrey
2,764,191 A	9/1956	Hartmann
2,843,167 A	7/1958	Rushton
2,890,730 A	6/1959	Gottlieb

(Continued)

FOREIGN PATENT DOCUMENTS

DE 879012 6/1953

(Continued)

OTHER PUBLICATIONS

Vermont American, Industrial Dovetail Jig, Model # 23461, Manual No. 45LCN-72, Aug. 1999, USA.

(Continued)

Primary Examiner—Gary D. Watson

Assistant Examiner—Patricia Palasik

(74) *Attorney, Agent, or Firm*—Goodwin Procter LLP

(57) **CLAIM**

The ornamental design for a sliding tapered dovetail and fixed half-blind dovetail template, as shown and described.

DESCRIPTION

FIG. 1 is a perspective view of the sliding tapered dovetail and fixed half-blind dovetail template.

FIG. 2 is a top view thereof.

FIG. 3 is a bottom view thereof.

FIG. 4 is a rear elevational view thereof.

FIG. 5 is a front elevational view thereof.

FIG. 6 is a right side elevational view thereof; and,

FIG. 7 is a left side elevational view thereof.

1 Claim, 5 Drawing Sheets

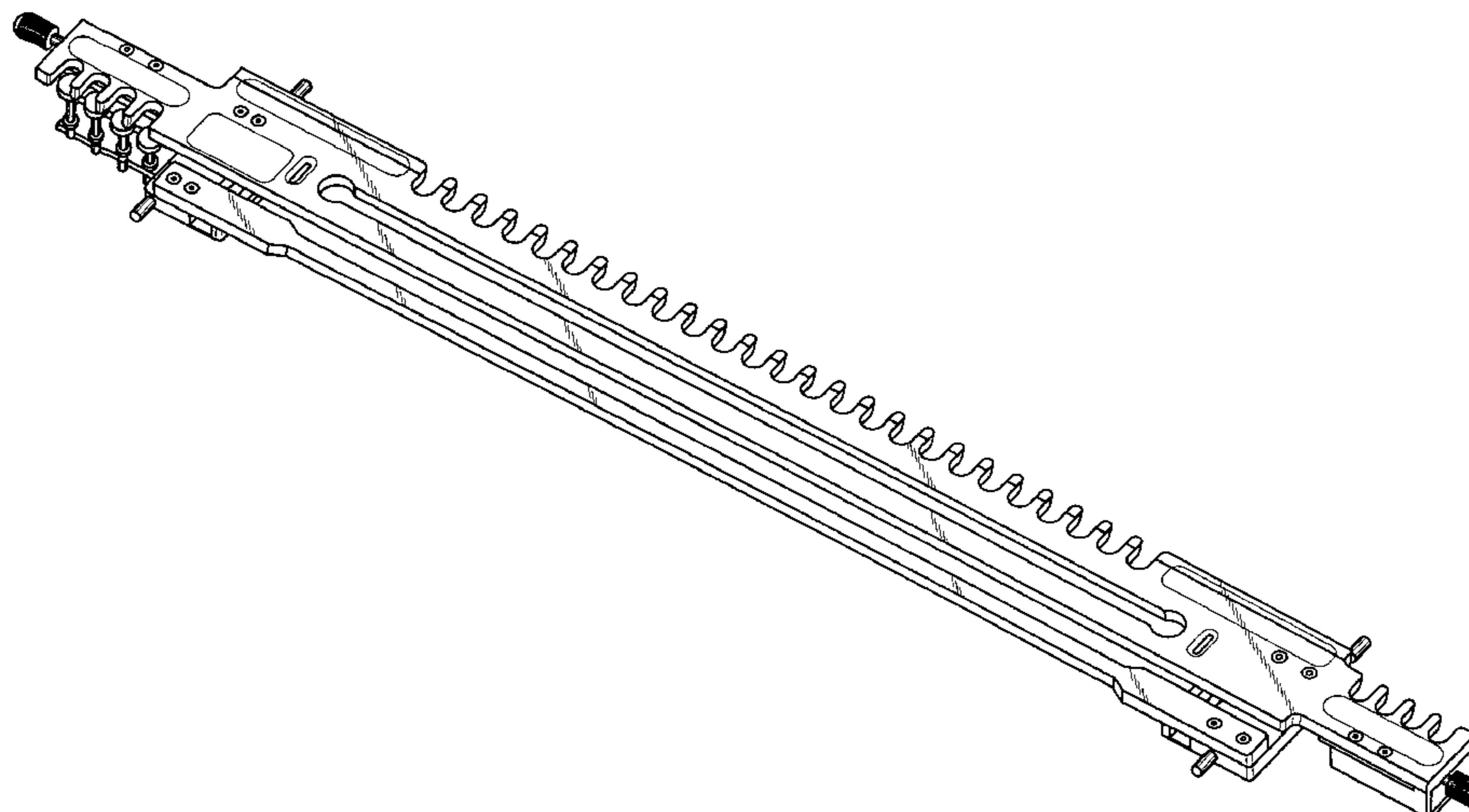

US D560,235 S

U.S. PATENT DOCUMENTS					
		5,016,691	A	5/1991	Bernier
		5,052,454	A	10/1991	Meinhardt
		5,056,966	A	10/1991	Lee
		5,067,537	A	11/1991	Offner
		5,076,742	A	12/1991	Lee et al.
		5,090,461	A	2/1992	Gakhar et al.
		5,094,279	A	3/1992	Dickey et al.
		5,114,265	A	5/1992	Grisley
		5,123,463	A	6/1992	Grisley
		5,139,062	A	8/1992	Keller
		5,143,132	A	9/1992	Keller
		5,154,214	A	10/1992	Hagerman
		5,156,508	A	10/1992	Grisley
		5,174,693	A	12/1992	Lee et al.
		5,199,477	A	4/1993	Keller
		5,203,389	A	4/1993	Goodwin
		5,222,997	A	6/1993	Montgomery
		D342,747	S	12/1993	Garcia
		5,273,090	A	12/1993	Klemma
		5,284,331	A	2/1994	Lee et al.
		5,285,831	A	2/1994	Woolgar
		5,285,832	A	2/1994	Gibson 144/144.51
		5,289,861	A	3/1994	Hedrick
		5,305,812	A	4/1994	Ferencsik
		D348,195	S	6/1994	Higgins et al.
		5,318,082	A	6/1994	Von Hollen
		5,325,899	A	7/1994	Kochling
		5,337,641	A	8/1994	Duginske
		5,345,983	A	9/1994	De Abreu
		5,396,937	A	3/1995	Clausen
		5,421,384	A	6/1995	Nuwordu
		5,423,357	A	6/1995	Szymanski 144/144.52
		5,423,360	A	6/1995	Taylor et al.
		5,452,751	A	9/1995	Engler, III et al.
		5,458,171	A	10/1995	Ward
		5,492,160	A	2/1996	McCracken
		5,494,089	A	2/1996	Lubbe
		5,513,437	A	5/1996	Whyte
		5,533,556	A	7/1996	Whitney
		5,562,208	A	10/1996	Hasler et al.
		5,564,483	A	10/1996	Sacchi
		5,584,328	A	12/1996	Grisley
		5,598,878	A	2/1997	Wirth, Jr. et al.
		5,617,909	A	4/1997	Duginske
		5,630,455	A	5/1997	Julien
		5,647,707	A	7/1997	Poulin
		5,692,861	A	12/1997	Stottmann
		5,694,992	A	12/1997	Kikuchi
		5,694,994	A	12/1997	Engler, III et al.
		5,697,415	A	12/1997	Kozyrski et al.
		5,711,356	A	1/1998	Grisley 144/144.51
		5,738,470	A	4/1998	Sugita
		5,738,966	A	4/1998	Okuno et al.
		5,779,407	A	7/1998	Tucker et al.
		5,807,033	A	9/1998	Benway
		5,809,631	A	9/1998	Poulin
		5,813,807	A	9/1998	Rogers
		5,816,300	A	10/1998	Rogers
		5,823,239	A	10/1998	Smith
		5,832,977	A	11/1998	Hampton
		5,853,035	A	12/1998	Rose
		5,862,848	A	1/1999	Beall
		5,868,183	A	2/1999	Kozyrski et al.
		5,893,402	A	4/1999	Darling
		5,908,061	A	6/1999	Blichmann
		5,918,652	A	7/1999	Tucker
		5,931,208	A	8/1999	Gifkins
		6,012,497	A	1/2000	Stottmann
		6,032,706	A	3/2000	Lear
		6,039,095	A	3/2000	Newman
		6,041,837	A	3/2000	Hanson
		6,061,921	A	5/2000	Adams et al.
		6,065,913	A	5/2000	Rogers
3,057,383	A	10/1962	Waite		
3,099,299	A	7/1963	Gilfry		
3,109,466	A	11/1963	Jones		
3,232,327	A	2/1966	Baranczyk		
3,301,287	A	1/1967	Edwards		
3,424,450	A	1/1969	Atkins		
3,442,309	A	5/1969	Jentsch		
3,450,001	A	6/1969	Fortune		
3,700,344	A	10/1972	Grumbach		
3,709,088	A	1/1973	Pitzer		
3,800,840	A	4/1974	McCord, Jr.		
3,834,435	A	9/1974	McCord, Jr.		
3,841,368	A	10/1974	Ritter		
3,878,875	A	* 4/1975	McCord, Jr. 144/87		
4,093,394	A	6/1978	Adams		
4,095,633	A	6/1978	Kimball et al.		
4,127,153	A	11/1978	Cipollone		
4,163,465	A	8/1979	Strong		
4,168,730	A	9/1979	Keller		
4,281,694	A	8/1981	Gorman		
4,319,615	A	3/1982	Ditmanson		
4,373,562	A	2/1983	Vernon		
4,382,728	A	5/1983	Anderson et al.		
4,403,534	A	9/1983	Altendorf et al.		
4,405,004	A	9/1983	Dicke		
4,407,344	A	* 10/1983	Dicke 144/87		
D272,038	S	* 1/1984	Dicke D8/71		
4,428,408	A	1/1984	Grisley		
4,438,977	A	3/1984	Chapel		
4,445,277	A	5/1984	Keefe		
4,462,440	A	7/1984	Dolfi		
4,478,264	A	10/1984	Miller et al.		
4,479,523	A	10/1984	Peterson et al.		
4,498,245	A	2/1985	Mayor		
4,542,776	A	9/1985	Kehoe		
4,575,059	A	3/1986	Blaine		
4,593,735	A	6/1986	Wirth, Jr.		
4,595,040	A	6/1986	Glisman		
4,603,717	A	8/1986	Thomas		
4,607,434	A	8/1986	Francis		
4,607,673	A	* 8/1986	McCord, Jr. 144/144.51		
4,630,656	A	12/1986	Collins		
4,630,657	A	12/1986	Obradovich		
4,644,985	A	2/1987	Weaver		
4,648,433	A	3/1987	Wolff		
4,655,445	A	4/1987	Morse		
4,693,288	A	9/1987	Buechele et al.		
4,735,531	A	4/1988	Boerckel et al.		
4,750,536	A	6/1988	Grisley		
4,763,706	A	8/1988	Rice et al.		
4,763,707	A	8/1988	Hounshell		
4,776,374	A	10/1988	Charlebois		
4,787,430	A	11/1988	Miyamoto		
4,787,432	A	11/1988	Williams		
4,805,505	A	2/1989	Cantlin		
4,809,755	A	* 3/1989	Pontikas 144/372		
4,843,728	A	7/1989	Francis		
4,850,763	A	7/1989	Jack et al.		
4,860,809	A	8/1989	Cotton et al.		
4,863,151	A	9/1989	Justesen		
4,875,510	A	* 10/1989	Muellers 144/145.2		
4,905,745	A	3/1990	Jaegar		
4,911,213	A	3/1990	Le Bleu		
4,930,221	A	6/1990	Taylor		
4,934,422	A	6/1990	Hempy et al.		
4,942,912	A	7/1990	Gakhar et al.		
4,965,943	A	10/1990	Adams		
4,965,966	A	10/1990	Braasch		
4,966,507	A	10/1990	Hanks		
4,977,938	A	12/1990	Greeson		
4,995,435	A	2/1991	Godfrey		

6,068,036	A	5/2000	Cassidy
6,076,575	A	6/2000	Harkness
6,116,303	A	9/2000	Hampton
6,116,826	A	9/2000	Benway
6,138,372	A	10/2000	Newman
6,148,879	A	11/2000	Liao
6,158,487	A	12/2000	Licari
6,182,371	B1	2/2001	Newman
6,206,060	B1	3/2001	Blake
6,289,956	B1	9/2001	Shriver
6,315,017	B1	11/2001	Stottmann
6,357,194	B1	3/2002	Jones, Jr.
6,363,982	B1	4/2002	Nixon, Jr.
6,374,878	B1	4/2002	Mastley et al.
6,401,772	B1	6/2002	Beitl
6,422,276	B1	7/2002	Kevan
6,470,930	B1	10/2002	Stottmann
6,499,224	B1	12/2002	Asick
6,516,842	B1	2/2003	Chang
6,588,468	B1	7/2003	Tucker et al.
6,607,016	B2	8/2003	Jones
D481,402	S	10/2003	Jenkins et al.
6,675,849	B1	1/2004	Lackley
6,679,659	B1	1/2004	Lasch et al.
6,705,810	B1	3/2004	Sugita
6,736,173	B1	5/2004	Grisley et al.
RE38,612	E	10/2004	Tucker et al.
6,799,615	B2	10/2004	Smith
6,834,730	B2	12/2004	Gass et al.
6,851,900	B2	2/2005	Tillemans et al.
6,899,152	B2	5/2005	Godfrey
6,926,477	B2	8/2005	Allemann et al.
2001/0011564	A1	8/2001	Darling
2002/0066497	A1	6/2002	Froggatt
2003/0041709	A1	3/2003	Jones
2003/0073395	A1	4/2003	Faccin et al.
2003/0145705	A1	8/2003	Miller
2003/0159758	A1	8/2003	Smith
2003/0172993	A1	9/2003	Godfrey
2003/0196726	A1	10/2003	Tucker et al.
2003/0230359	A1	12/2003	Schroeder
2004/0050451	A1	3/2004	Dahlhoff
2004/0126197	A1	7/2004	Allemann et al.
2004/0149112	A1	8/2004	Snell
2004/0206865	A1	10/2004	Chang
2004/0250880	A1	12/2004	Dement
2005/0022899	A1	2/2005	Chang
2005/0056344	A1	3/2005	Freidlund
2005/0056345	A1	3/2005	Duginske
2005/0115639	A1	6/2005	Bagnall
2005/0161357	A1	7/2005	Allan et al.
2005/0236069	A1	10/2005	O'Brien
2006/0138722	A1	6/2006	Webster et al.
2006/0283524	A1*	12/2006	McDaniel et al. 144/144.51

FOREIGN PATENT DOCUMENTS

DE	3430496	A1	2/1986
DE	3517146	A1	11/1986
DE	4016834	A1	11/1991
DE	4403534	A1	8/1995
DE	19715422	A1	10/1998
DE	19715424	A1	10/1998
EP	0320869	A2	12/1987
FR	2843167	A1	7/2003
GB	2238752	A	6/1991
WO	WO 02/057058	A2	7/2002

OTHER PUBLICATIONS

Vermont American, Dovetail Fixture Kit, Owner's Manual Model No. 23460, Feb. 1996, USA.

Fusso Machinery Corp., Easy-to-Operate Dovetail Machine, http://fusso.trustpass.alibaba.com/product/10770195/Easy_to_Operate_Dovetail_Machine.html, p. 2-3, (printed Nov. 17, 2005).

Akeda DC User Manual, © 2002-2005 Akeda Jigs Incorporated; Akeda Canada, P.O. Box 700, The Old Laughing Creek Steam Works, Brackendale BC, V0N 1H0, Canada; www.akeda.com; 26 pages.

Porter-Cable, Instruction Manual, Dovetail Jig, Models 4210 & 4212, May 27, 2005.

Porter-Cable Omnijig Dovetail Machines Instruction Manual, Model 7116; Part No. 888381-794; Porter-Cable Corporation, 4825 Highway 45 North, Jackson, TN 38305; <http://www.porter-cable.com>; 28 pages). (NOTE: #6 and #23 are the same—the manual references both 5116 and 7116).

Porter-Cable, OMNIJIG Dovetail Machine, Parts List for 5116 Type 1, © 2005.

One (1) image of Porter-Cable Model 517, Lock Face Templet; Porter-Cable Corporation, 4825 Highway 45 North, Jackson, TN 38305; Porter-Cable Catalog, PC-912, p. 137, 1995; 1 page.

One (1) image of Porter-Cable Model 517, Lock Face Templet; Porter-Cable Corporation, 4825 Highway 45 North, Jackson, TN 38305; http://media.ptg-online.com/20040310083334_517_72dpi_500.jpg; 1 page.

One (1) image of Porter-Cable Model 59381, Hinge Butt Templet Kit; Porter-Cable Corporation, 4825 Highway 45 North, Jackson, TN 38305 ; Porter-Cable Catalog, PC-912, p. 134, 1995; 1 page.

Two (2) images of Porter-Cable Model 59381, Hinge Butt Templet; Porter-Cable Corporation, 4825 Highway 45 North, Jackson, TN 38305; 2 pages.

Five (5) images of Porter-Cable Model 59370, Door Hinge Templet; Porter-Cable Corporation, 4825 Highway 45 North, Jackson, TN 38305; 5 pages.

Four (4) images of Rockwell Model 521, Stair Templet Without Clamping Devices; Power Tool Division/Rockwell International, Pittsburgh, PA 15208; 4 pages.

Three (3) images of Modern Woodworking by Willis H. Wagner; Illustrating use of Rockwell Model 521, Stair Templet With Clamp Devices; © 1980 The Goodheart-Willcox Co., Inc., pp. 252-253; 3 pages.

Trend MT Jig Review, http://benchmark.20m.com/reviews/TrendMortiseJig/TrendMT_JigReview.html; Nov. 9, 2005; 5 pages.

Leigh Versus Akeda Dovetail Jig, <http://benchmark.20m.com/articles/LeighVersusAkeda.html>; Nov. 9, 2005; 8 pages.

Katie Jig System brochure; Hampton House Inc., P.O. Box 7103, Greenwood, IN 46142-6421; <http://www.katijig.com/KJ8PG.pdf>; U.S. Patent Nos. 5,832,977 and 6,116,303; Nov. 9, 2005; 8 pages.

The Katie Jig Manual, © 1997-2000 Hampton House, Inc. Hampton House Inc., P.O. Box 7103, Greenwood, IN 46142-6421; <http://www.katijig.com>; U.S. Patent No. 5,832,977; Nov. 9, 2005; 34 pages.

Porter-Cable Dovetail Machine, Parts List: Model 4112; Parts List No. 900488-0011; © 2000 Porter-Cable Corporation, 4825 Highway 45 North, Jackson, TN 38305; 1 page.

Porter-Cable Dovetail Fixture/Jig Instruction Manual, Model 4112; Part No. 900487-09-12-03; © 2003 Porter-Cable Corporation, 4825 Highway 45 North, Jackson, TN 38305; 15 pages.

Porter-Cable Omnijig Dovetail Machine Parts List; Model 7116; Parts List No. 876389-002; © 2000 Porter-Cable Corporation, 4825 Highway 45 North, Jackson, TN 38305; 3 pages.

Porter-Cable Omnijig Dovetail Machines Instruction Manual, Model 7116; Part No. 888381-794; Porter-Cable Corporation, 4825 Highway 45 North, Jackson, TN 38305; <http://www.porter-cable.com>; 28 pages).

* cited by examiner

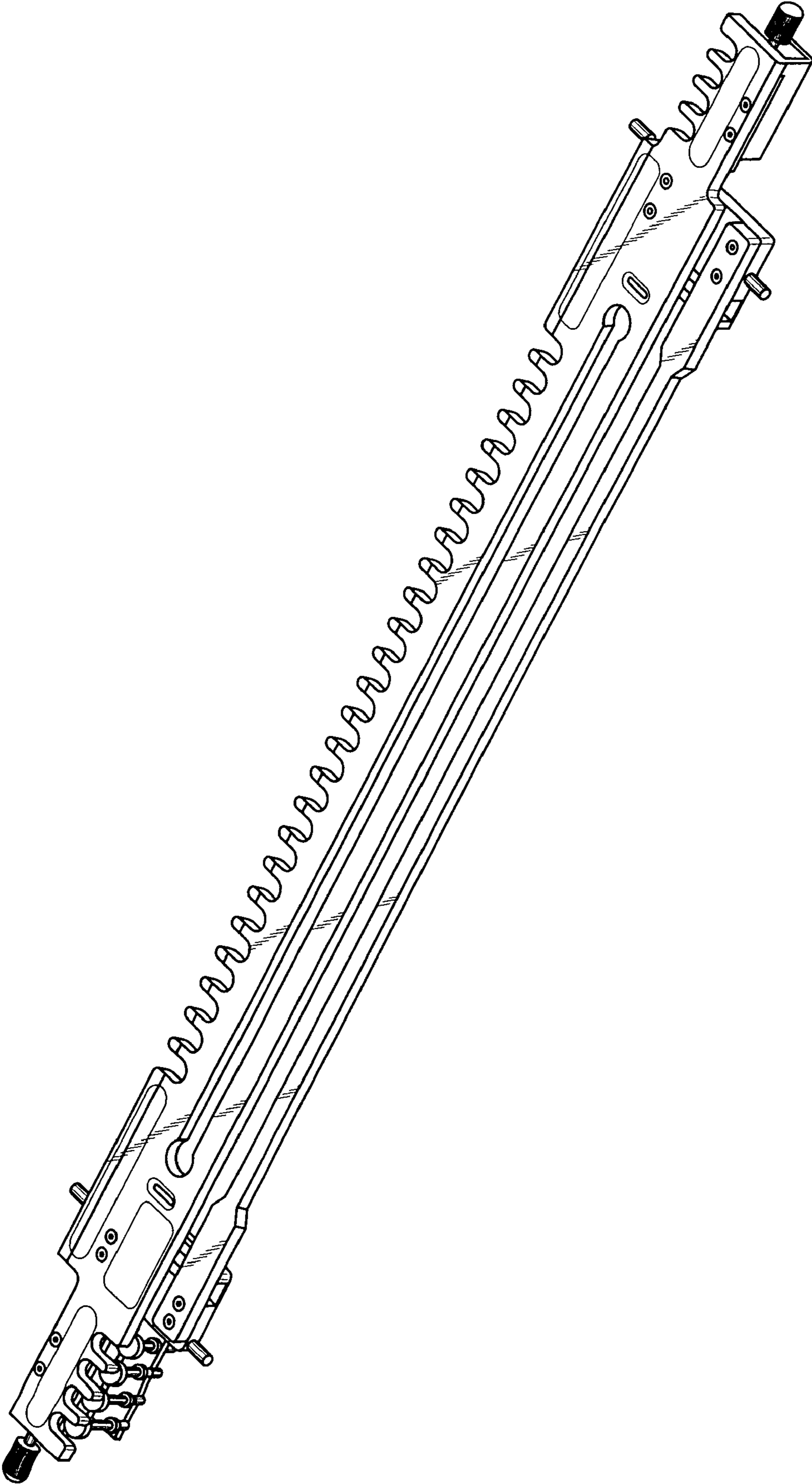

Fig. 1

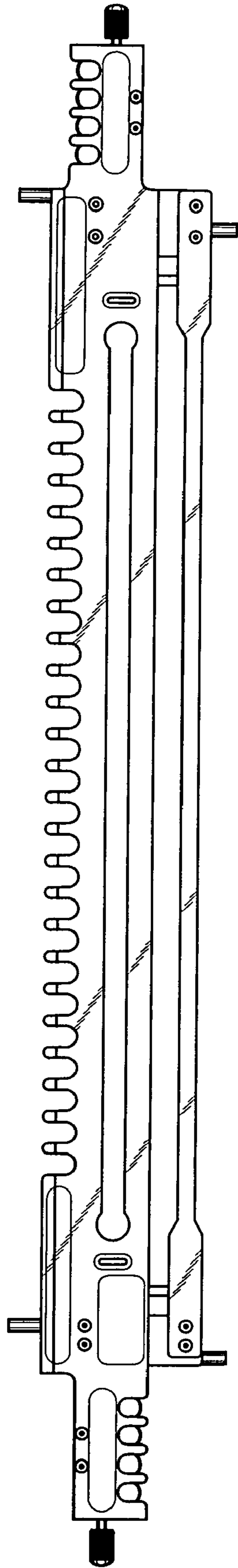

Fig. 2

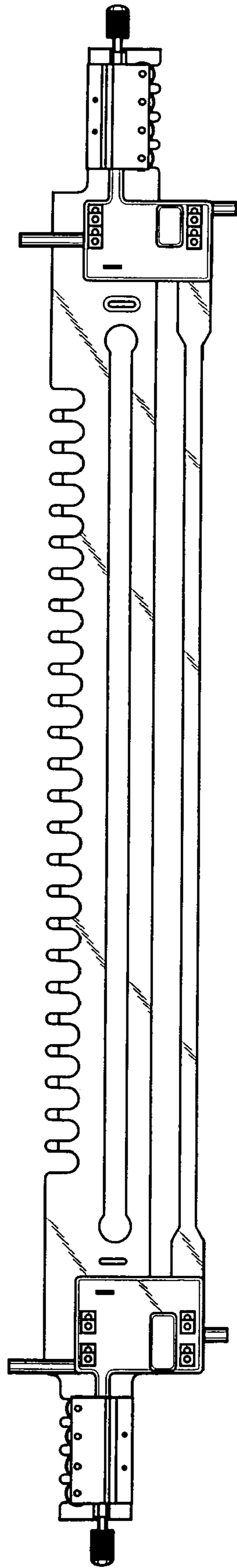

Fig. 3

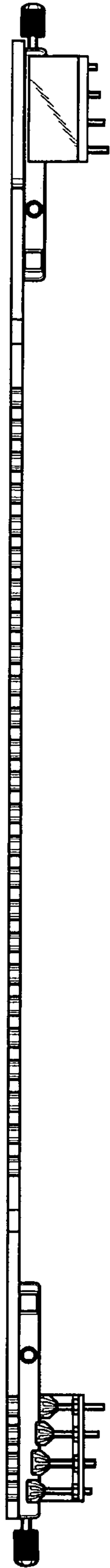

Fig. 4

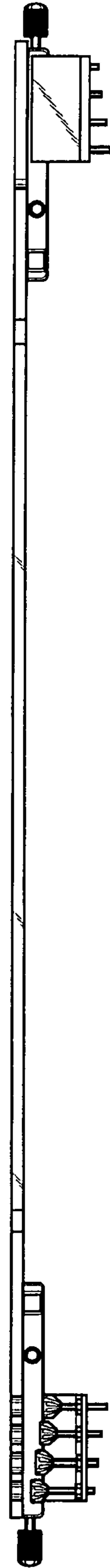

Fig. 5

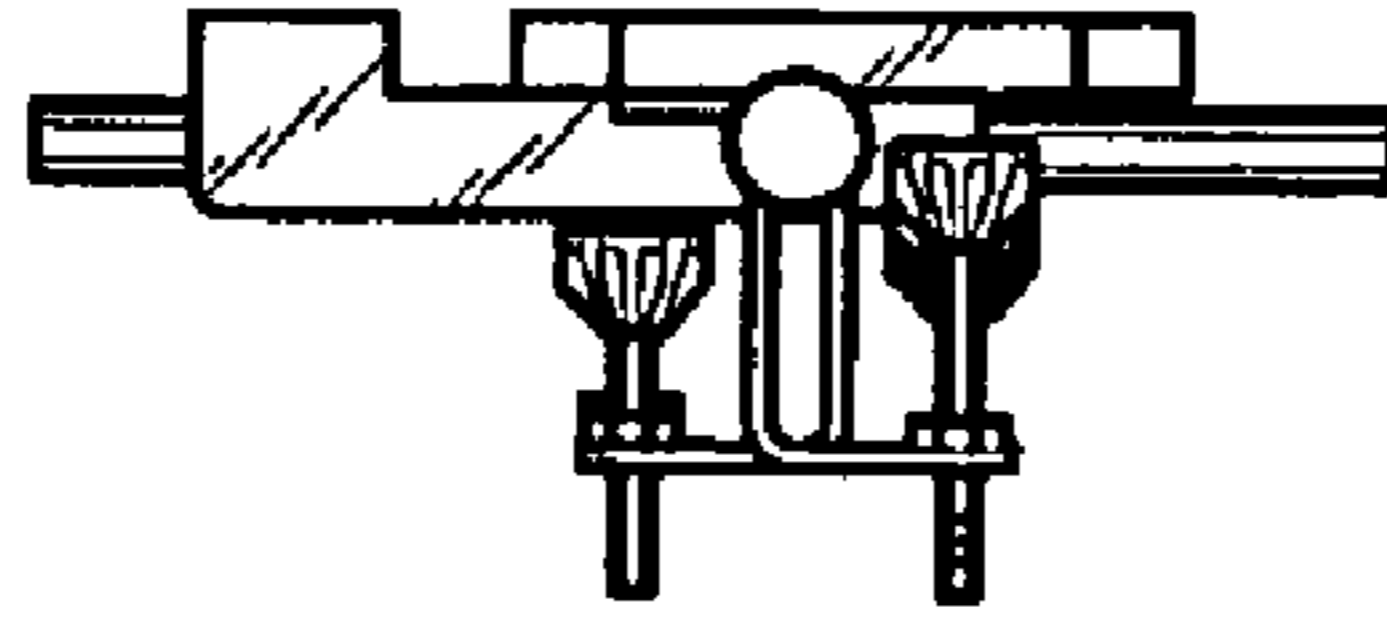

Fig. 6

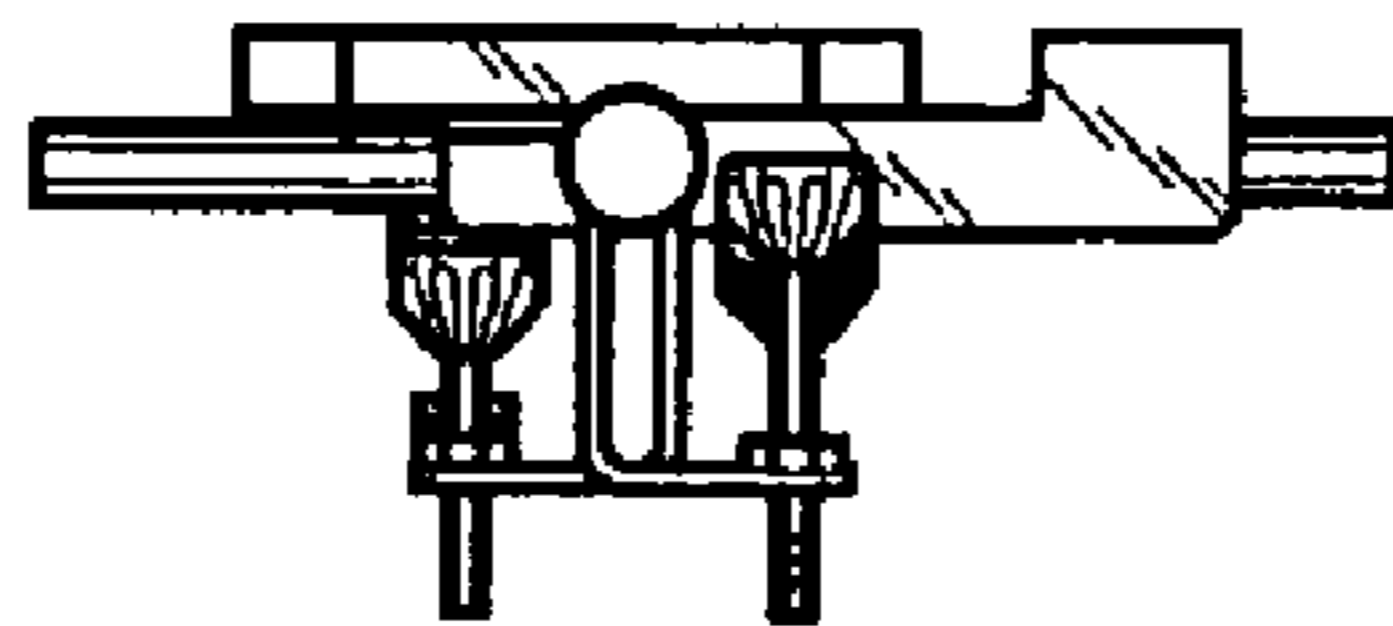

Fig. 7