

US00D560193S

(12) **United States Design Patent**
Sung et al.

(10) **Patent No.:** **US D560,193 S**
(45) **Date of Patent:** **** Jan. 22, 2008**

(54) **CELLULAR PHONE**

(75) Inventors: **Kyung-Eun Sung**, Seoul (KR);
Sang-Min Hyun, Seoul (KR);
Chang-Soo Lee, Incheon (KR)

(73) Assignee: **Samsung Electronics Co., Ltd.**,
Suwon-Si (KR)

(**) Term: **14 Years**

(21) Appl. No.: **29/270,448**

(22) Filed: **Dec. 26, 2006**

(51) **LOC (8) Cl.** **14-03**

(52) **U.S. Cl.** **D14/138**

(58) **Field of Classification Search** D14/137,
D14/138, 147, 218, 247-248, 341-347, 496;
455/90.3, 556.1, 556.2, 575.1, 575.3, 575.4;
379/433.01-433.13; 361/814; 348/14.02

See application file for complete search history.

(56) **References Cited**

U.S. PATENT DOCUMENTS

| | | | | |
|--------------|---------|----------------|-------|---------|
| D337,569 S * | 7/1993 | Kando | | D14/341 |
| D457,883 S * | 5/2002 | Sugioka et al. | | D14/342 |
| D466,096 S * | 11/2002 | Takada | | D14/138 |
| D470,782 S * | 2/2003 | Motomizu | | D10/92 |
| D479,215 S * | 9/2003 | Yokoyama | | D14/138 |
| D496,933 S * | 10/2004 | Wu | | D14/346 |
| D503,171 S * | 3/2005 | Park et al. | | D14/346 |
| D503,699 S * | 4/2005 | Lee et al. | | D14/138 |
| D512,393 S * | 12/2005 | Lee et al. | | D14/138 |
| D519,998 S * | 5/2006 | Park | | D14/346 |
| D526,301 S * | 8/2006 | Shin | | D14/138 |
| D526,302 S * | 8/2006 | Kim | | D14/138 |
| D527,717 S * | 9/2006 | Kim | | D14/138 |
| D528,090 S * | 9/2006 | Lee et al. | | D14/138 |
| D528,526 S * | 9/2006 | Shin | | D14/138 |
| D530,699 S * | 10/2006 | Lee et al. | | D14/138 |
| D539,773 S * | 4/2007 | Kim et al. | | D14/138 |
| D543,168 S * | 5/2007 | Kim | | D14/138 |
| D543,176 S * | 5/2007 | Hyun et al. | | D14/138 |
| D545,289 S * | 6/2007 | Wang | | D14/138 |

| | | | | |
|-------------------|--------|--------------|-------|-----------|
| D545,291 S * | 6/2007 | Chuang | | D14/138 |
| D547,292 S * | 7/2007 | Kim et al. | | D14/138 |
| 2003/0125094 A1 * | 7/2003 | Hyun et al. | | 455/566 |
| 2005/0107119 A1 * | 5/2005 | Lee et al. | | 455/556.1 |
| 2006/0094464 A1 * | 5/2006 | Kyou et al. | | 455/556.1 |
| 2006/0211460 A1 * | 9/2006 | Jeong et al. | | 455/575.4 |

OTHER PUBLICATIONS

HTC P4350, announced Nov. 2006, [online], [retrieved on Feb. 20, 2007]. Retrieved from Internet ,<URL: <http://www.gsmarena.com>>.*

Samsung P930, announced Dec. 2006, [online], [retrieved on Feb. 8, 2007]. Retrieved from Internet ,<URL: <http://www.gsmarena.com>>.*

* cited by examiner

Primary Examiner—Jeffrey Asch

Assistant Examiner—Bridget L Eland

(74) *Attorney, Agent, or Firm*—Staas & Halsey LLP

(57) **CLAIM**

The ornamental design for a cellular phone, as shown and described.

DESCRIPTION

FIG. 1 is a perspective view of a cellular phone according to our new design;

FIG. 2 is a front elevational view thereof;

FIG. 3 is a rear elevational view thereof;

FIG. 4 is a left side elevational view thereof;

FIG. 5 is a right side elevational view thereof;

FIG. 6 is a top plan view thereof;

FIG. 7 is a bottom plan view thereof; and,

FIG. 8 is a front elevational view of the cellular phone according to our new design in a state in which the cellular phone is open to be used.

The surface(s) or portion(s) of the article not shown in the drawing or described in the specification form(s) no part of the claimed design.

1 Claim, 8 Drawing Sheets

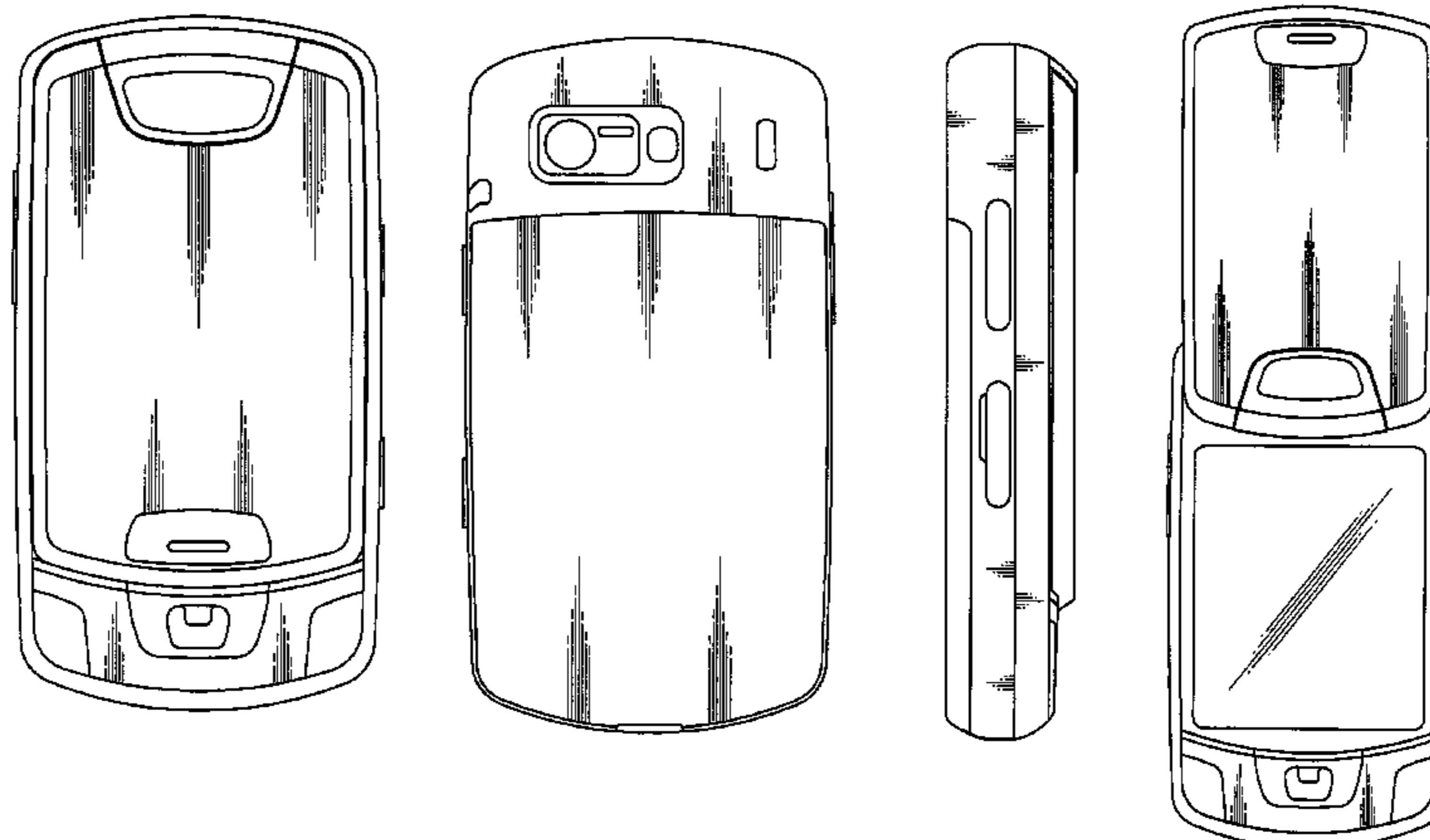

FIG.1

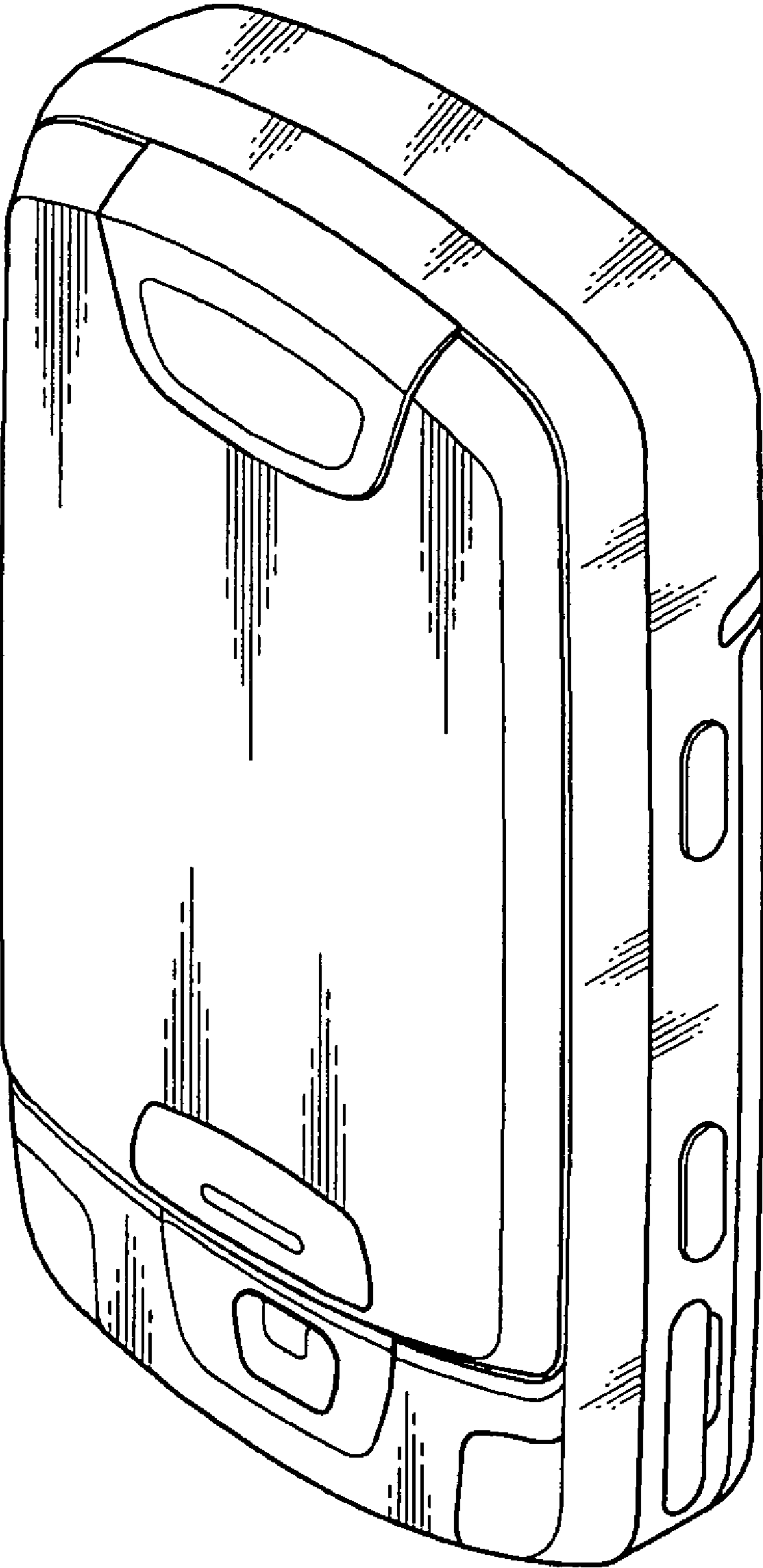

FIG.2

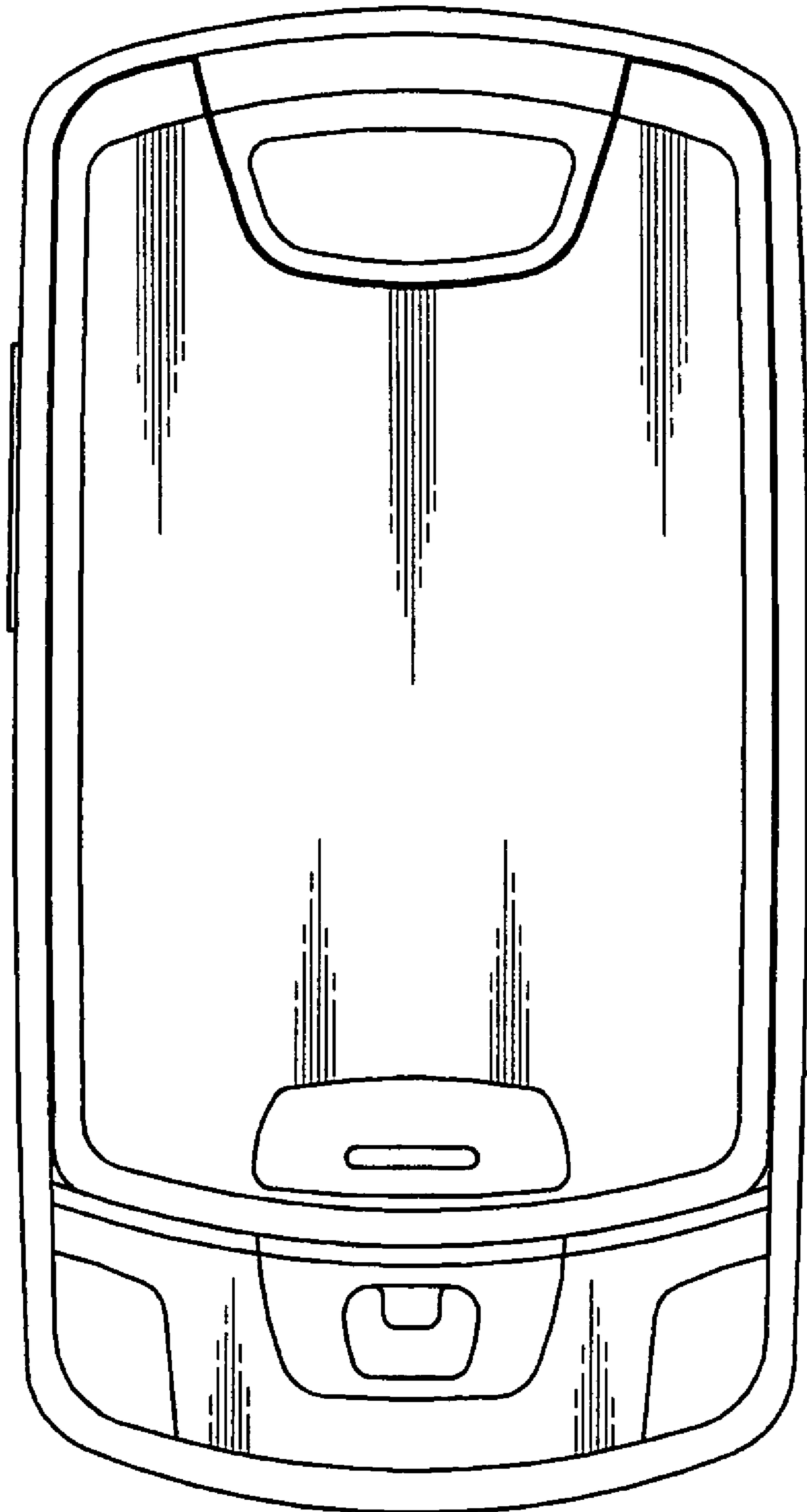

FIG.3

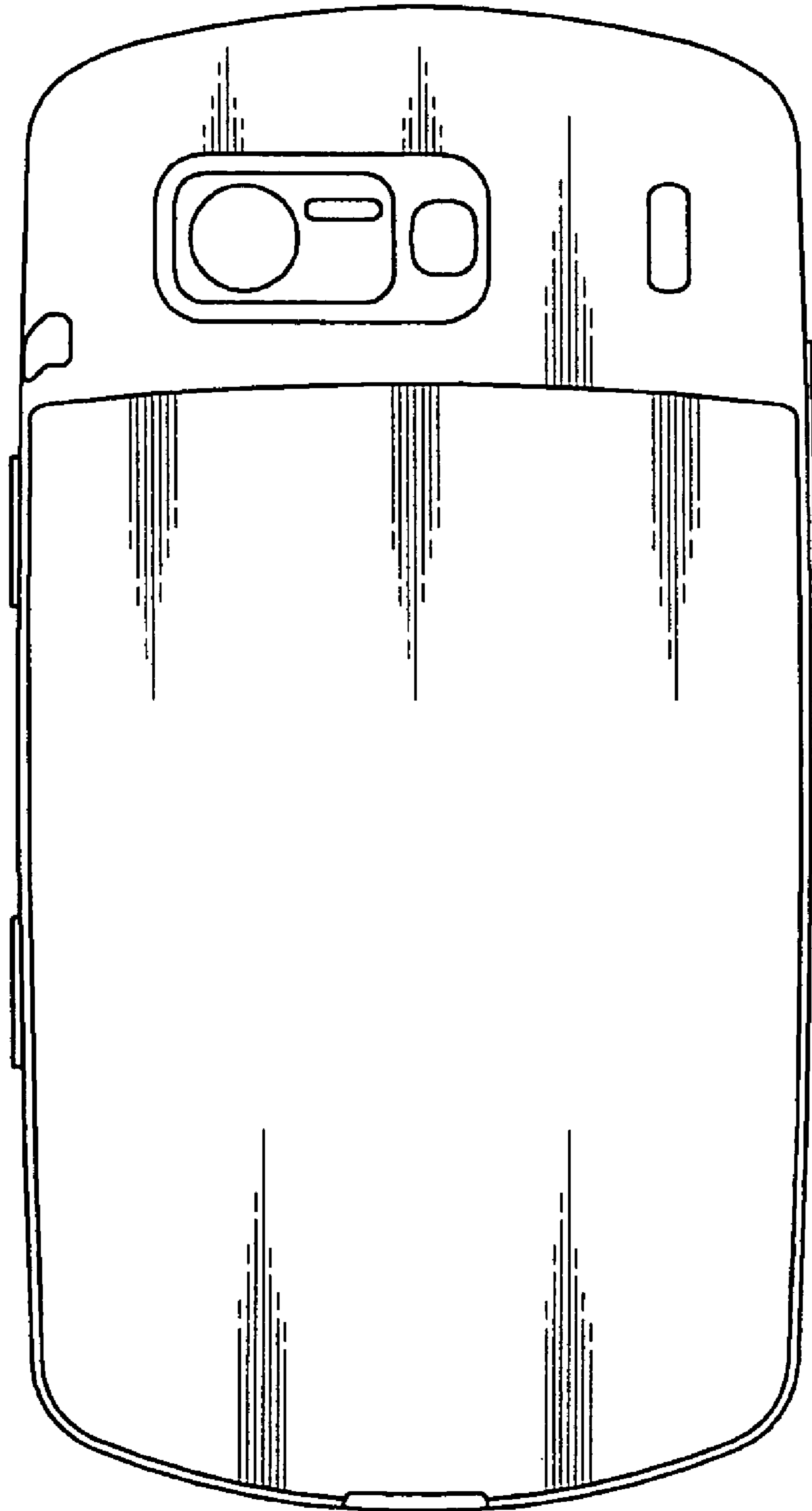

FIG.4

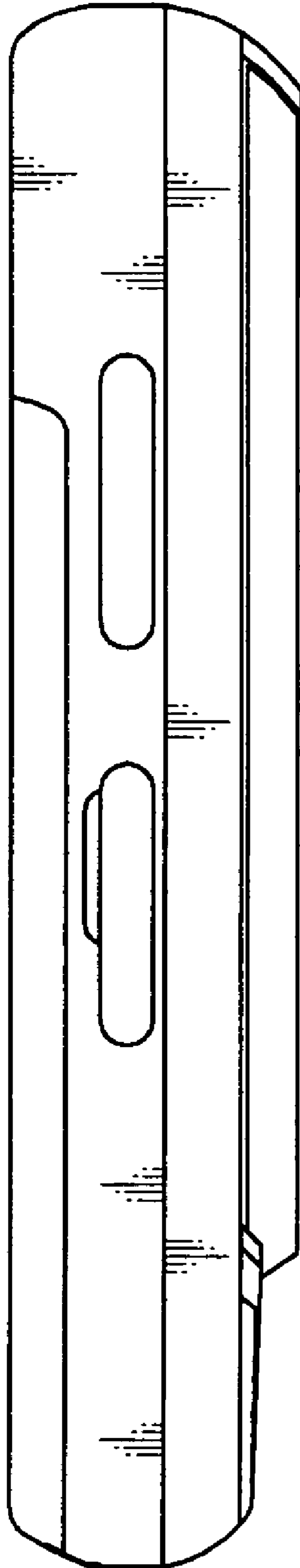

FIG. 5

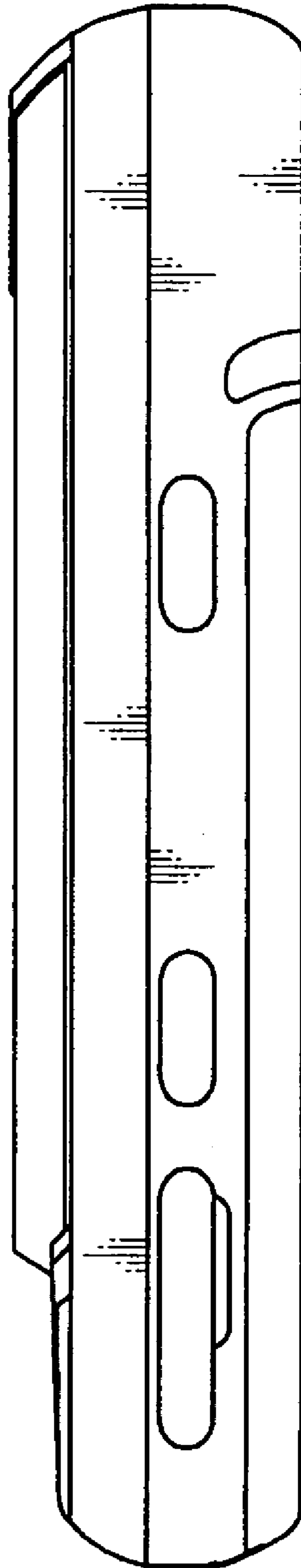

FIG.6

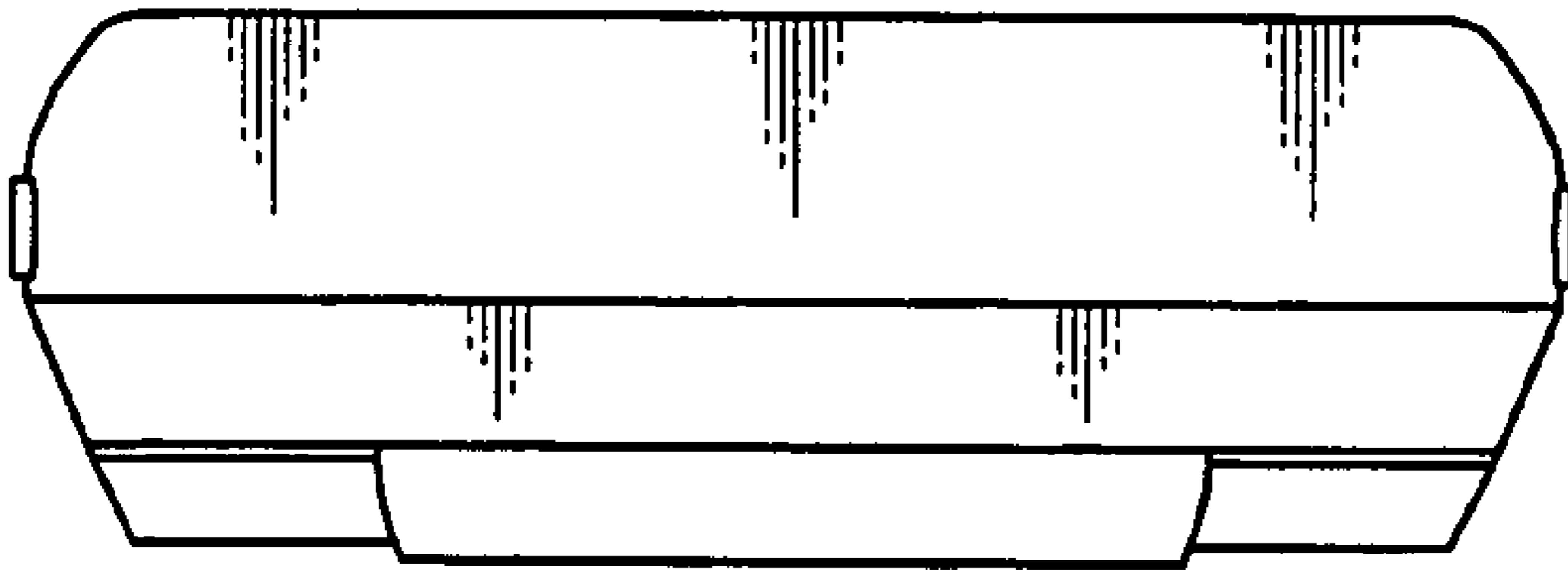

FIG. 7

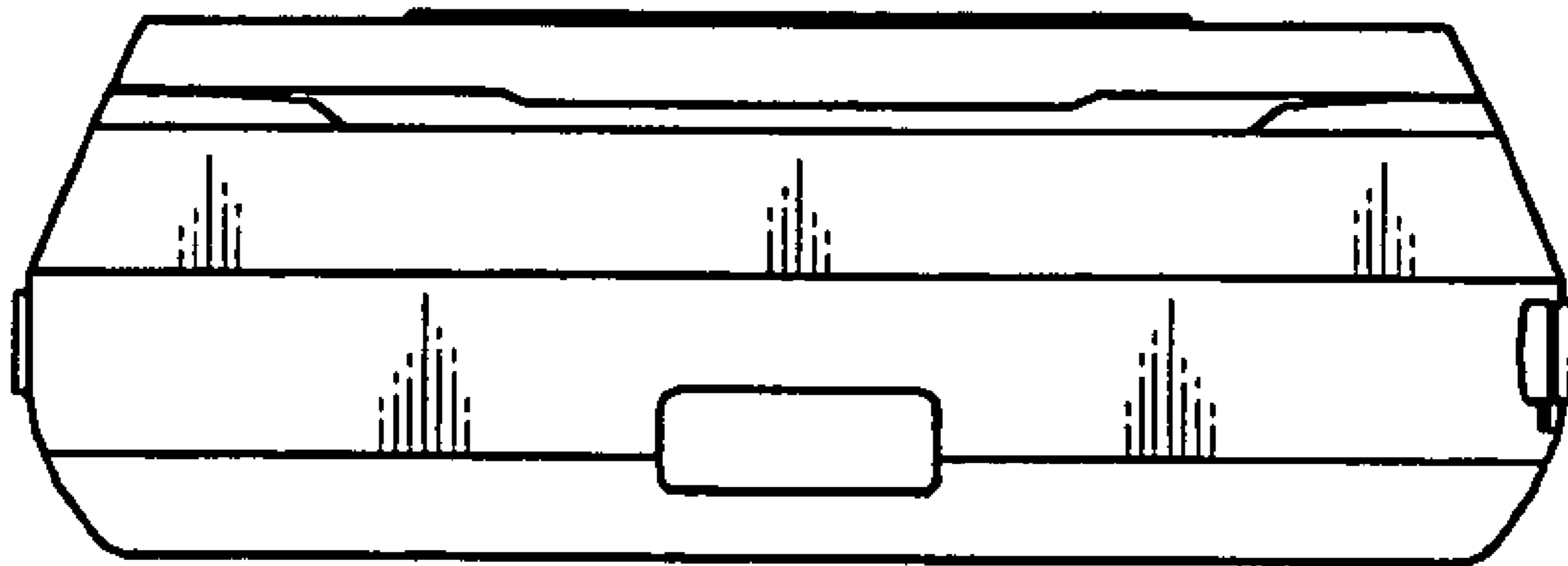

FIG.8

