



US00D560159S

(12) **United States Design Patent**  
**Matsumoto**

(10) **Patent No.:** **US D560,159 S**

(45) **Date of Patent:** **\*\* \*Jan. 22, 2008**

(54) **BATTERY FOR VIDEO CAMERA**

D512,018 S \* 11/2005 Matsuda et al. .... D13/103  
D515,499 S \* 2/2006 Matsuda et al. .... D13/103

(75) Inventor: **Hiroyuki Matsumoto**, Kadoma (JP)

FOREIGN PATENT DOCUMENTS

(73) Assignee: **Matsushita Electric Industrial Co., Ltd.**, Osaka (JP)

JP	D1202206	4/2004
JP	D1202422	4/2004
JP	D1202423	4/2004
JP	D1269248	4/2006
JP	D1269561	4/2006
JP	D1269562	4/2006

(\* ) Notice: This patent is subject to a terminal disclaimer.

(\*\*) Term: **14 Years**

\* cited by examiner

(21) Appl. No.: **29/272,016**

*Primary Examiner*—Cathron Brooks  
*Assistant Examiner*—Rosemary K Tarcaza

(22) Filed: **Jan. 31, 2007**

(74) *Attorney, Agent, or Firm*—Brinks Hofer Gilson & Lione

(30) **Foreign Application Priority Data**

Aug. 10, 2006 (JP) ..... 2006-021316

(57) **CLAIM**

(51) **LOC (8) Cl.** ..... **13-02**

I claim the ornamental design for a battery for video camera, as shown and described.

(52) **U.S. Cl.** ..... **D13/103**

(58) **Field of Classification Search** ..... D13/102–106,  
D13/110, 118–119, 184; 429/96–100, 163,  
429/176

**DESCRIPTION**

See application file for complete search history.

FIG. 1 is a front perspective view of a battery for video camera of the present invention;

FIG. 2 is a rear perspective view thereof;

FIG. 3 is a front view thereof;

FIG. 4 is a first side view thereof;

FIG. 5 is a second side view thereof;

FIG. 6 is a top view thereof;

FIG. 7 is a bottom view thereof; and,

FIG. 8 is a rear view thereof.

(56) **References Cited**

U.S. PATENT DOCUMENTS

D299,226 S *	1/1989	Toth et al. ....	D13/103
D305,639 S *	1/1990	Miki et al. ....	D13/103
D376,346 S *	12/1996	Ullrich ....	D13/103
D439,217 S	3/2001	Melnicoff	
D446,183 S *	8/2001	Miyashita ....	D13/103
D487,250 S	3/2004	Kikutani	
D503,673 S *	4/2005	Rosengrant ....	D13/103
D503,922 S	4/2005	Shimizu	

**1 Claim, 4 Drawing Sheets**

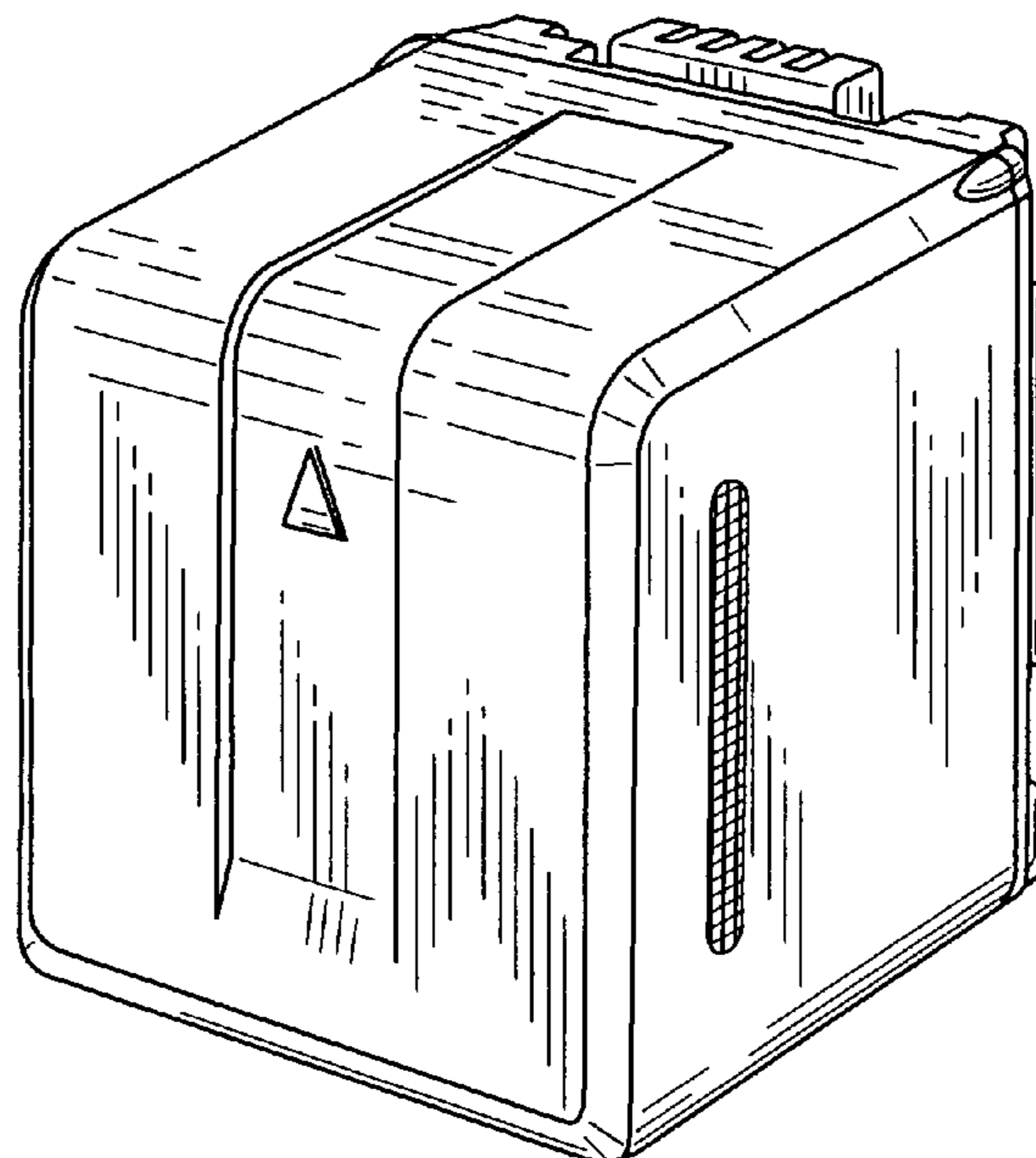

FIG.1

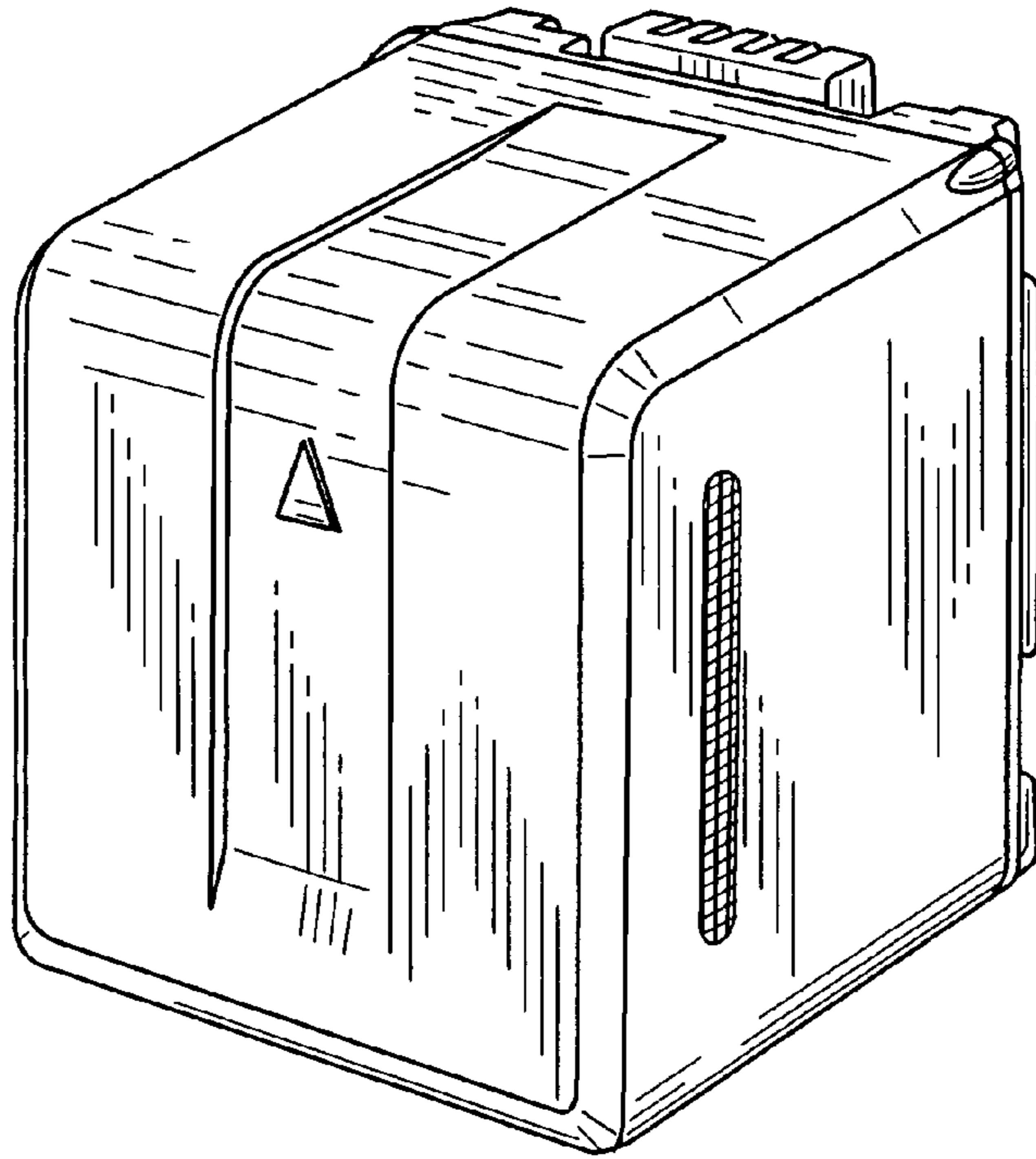

FIG.2

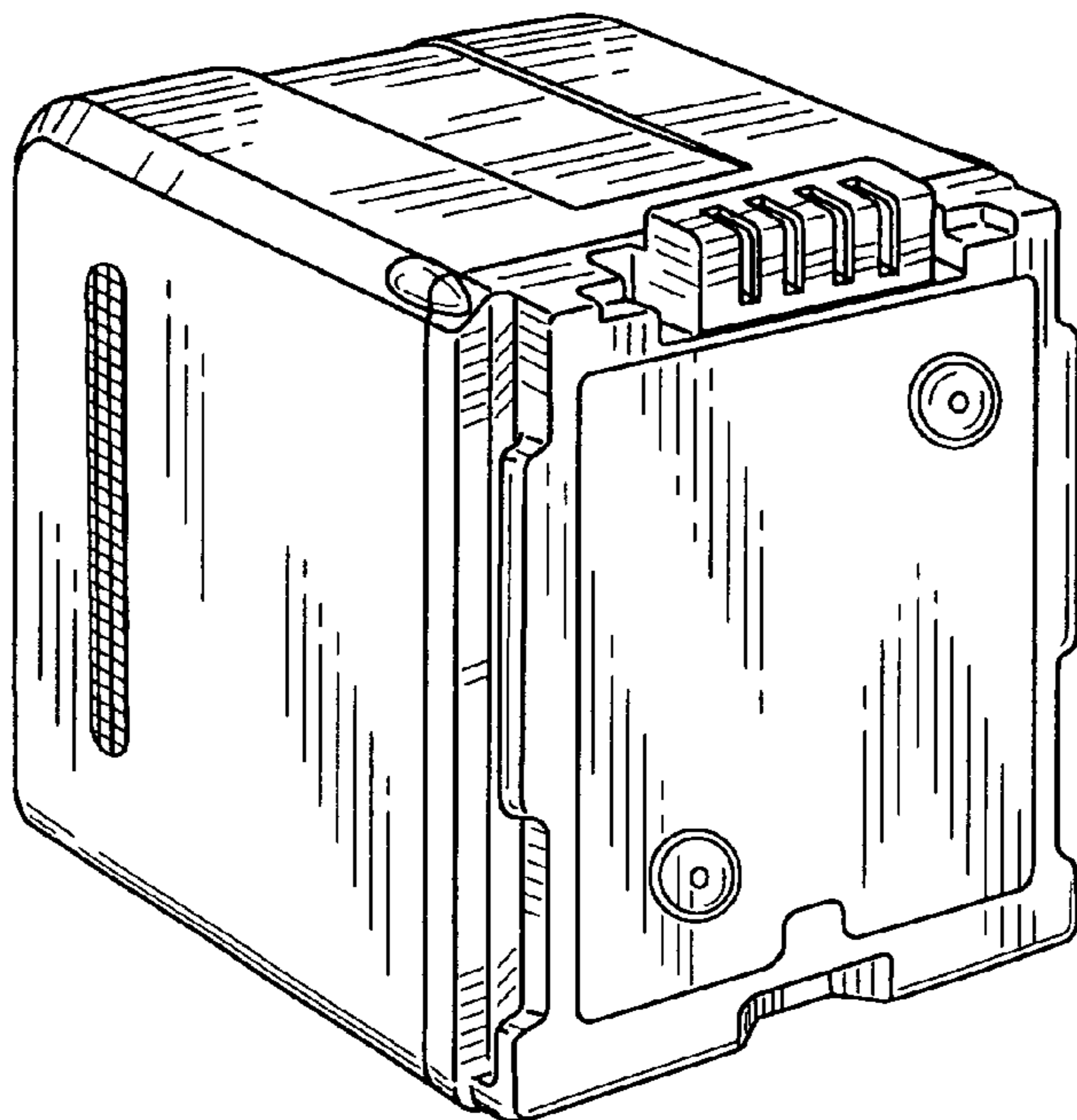

FIG.3

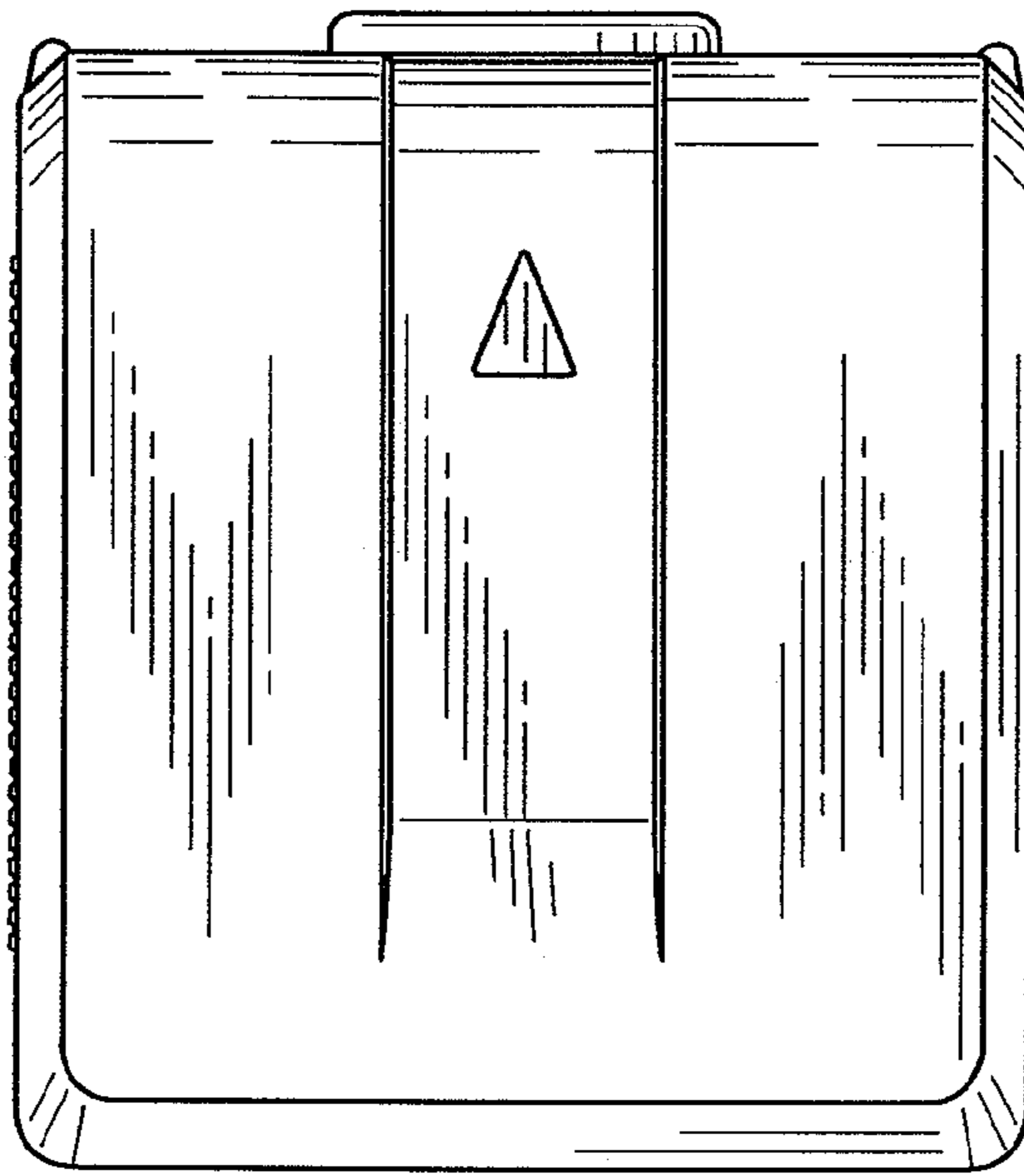

FIG.4

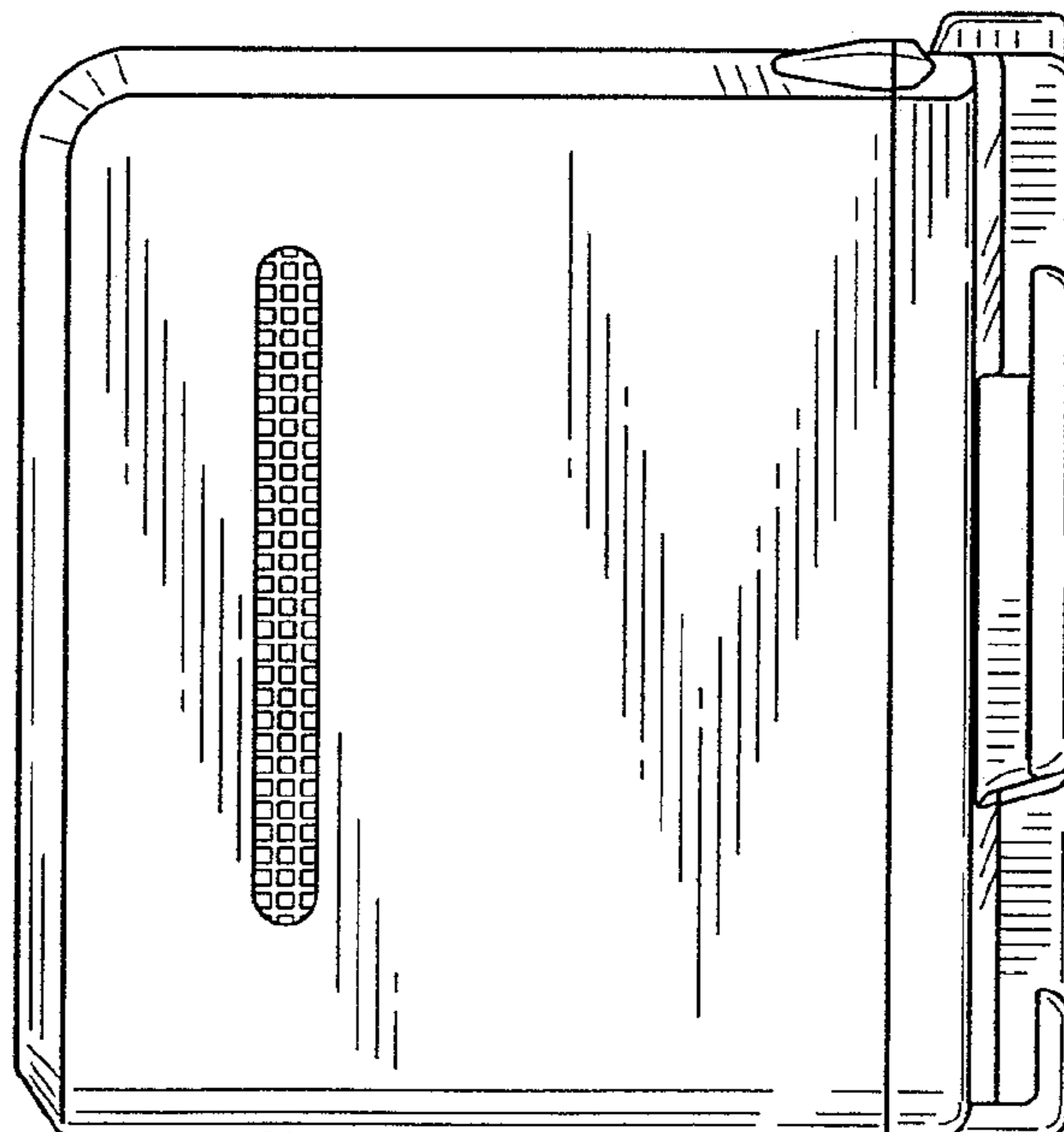

FIG.5

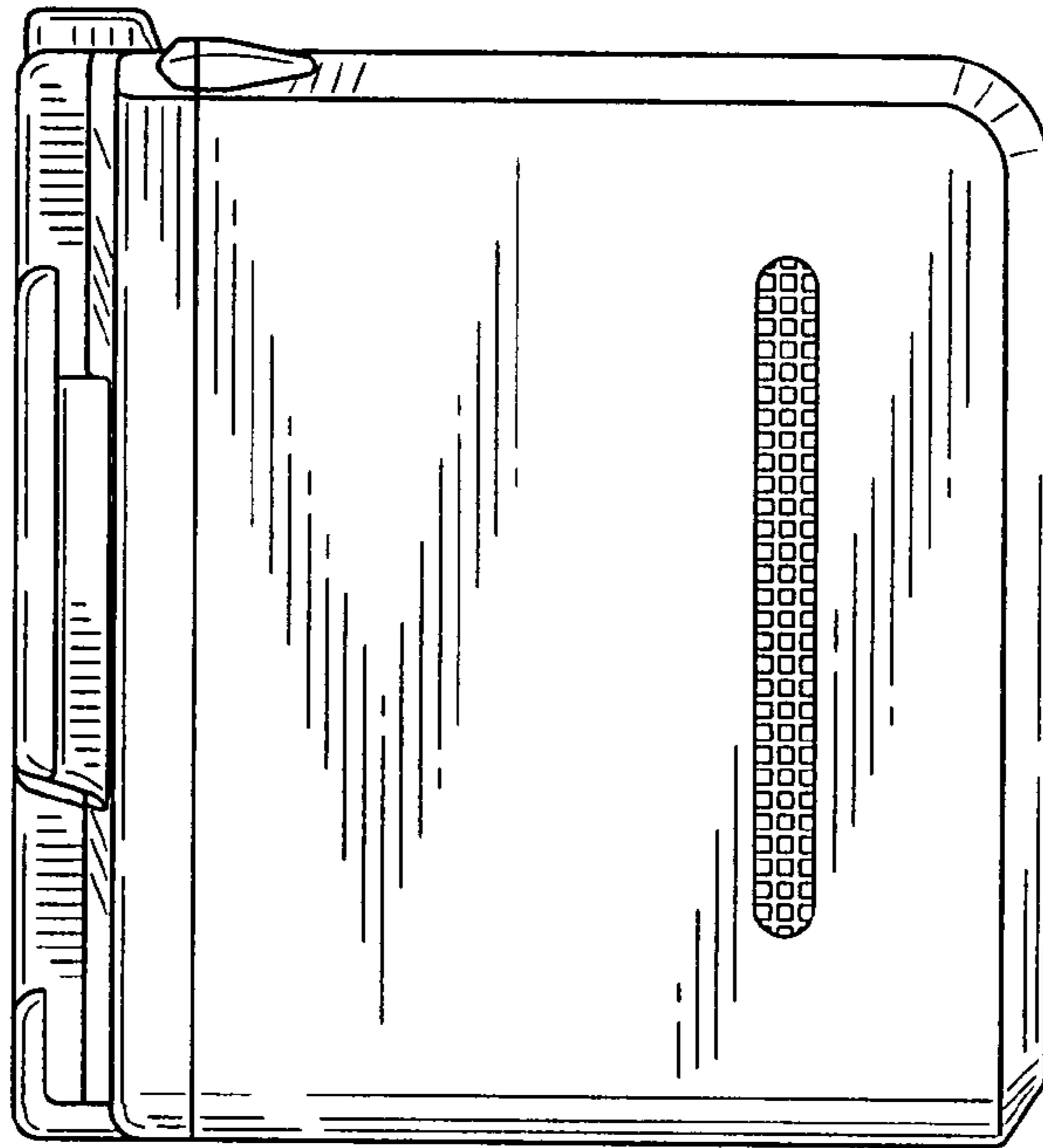

FIG.6

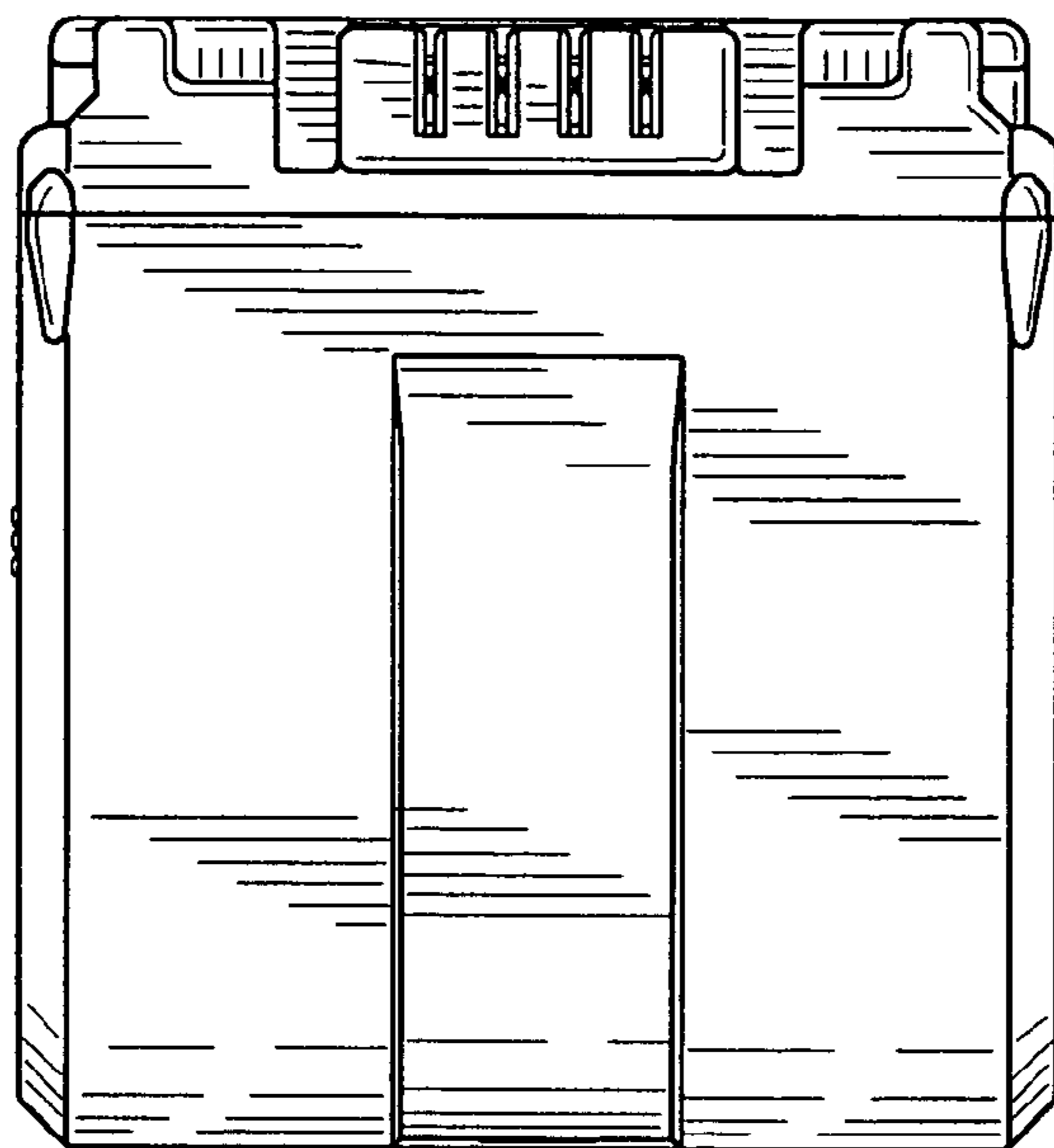

FIG.7

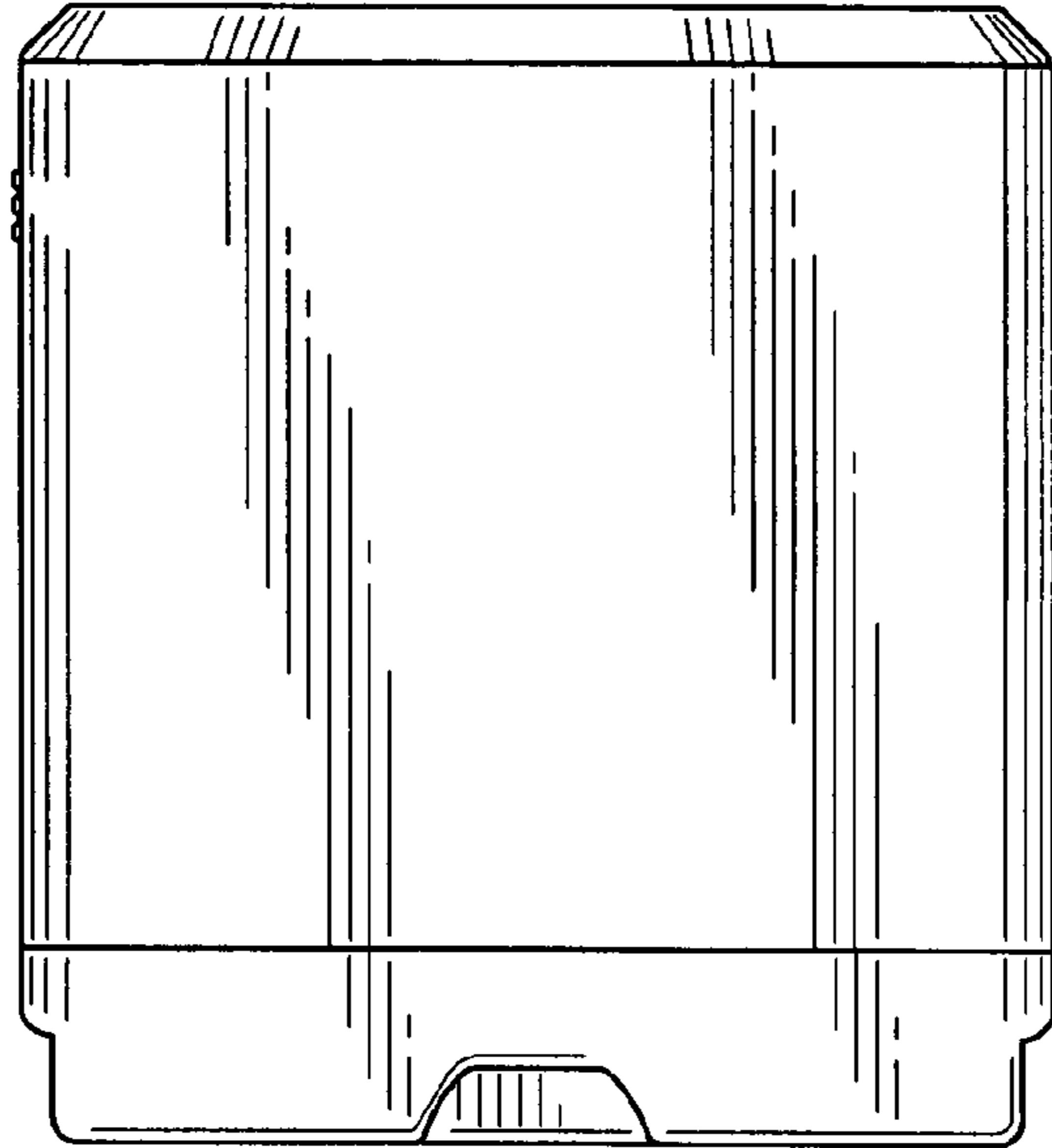

FIG.8

