



US00D560024S

(12) **United States Design Patent**  
**Jeffries**

(10) **Patent No.:** **US D560,024 S**  
(45) **Date of Patent:** **\*\* Jan. 15, 2008**

(54) **TRUCK SIGNAL HOUSING**

D485,934 S \* 1/2004 Tsai ..... D26/139  
D509,923 S \* 9/2005 Arthur et al. .... D26/139

(76) Inventor: **Jerry L. Jeffries**, 2911 E. Mirra Loma,  
Suite 27, Anaheim, CA (US) 92806

\* cited by examiner

(\*\*) Term: **14 Years**

*Primary Examiner*—Marcus A. Jackson

(21) Appl. No.: **29/288,752**

(57) **CLAIM**

I claim the ornamental design for the truck signal housing,  
as shown.

(22) Filed: **Jun. 21, 2007**

**DESCRIPTION**

(51) **LOC (8) Cl.** ..... **26-99**

FIG. 1 is a left perspective view of the ornamental design;

(52) **U.S. Cl.** ..... **D26/139**

FIG. 2 is a top view of the ornamental design;

(58) **Field of Classification Search** ..... D26/28-36,  
D26/139; 362/61, 80, 81, 82, 83, 376  
See application file for complete search history.

FIG. 3 is a front view of the ornamental design;

FIG. 4 is a back view of the ornamental design;

FIG. 5 is a bottom view of the ornamental design;

FIG. 6 is a right end view of the ornamental design; and,

FIG. 7 is a left end view of the ornamental design.

(56) **References Cited**

**U.S. PATENT DOCUMENTS**

D440,694 S \* 4/2001 Jeffries ..... D26/139

**1 Claim, 4 Drawing Sheets**

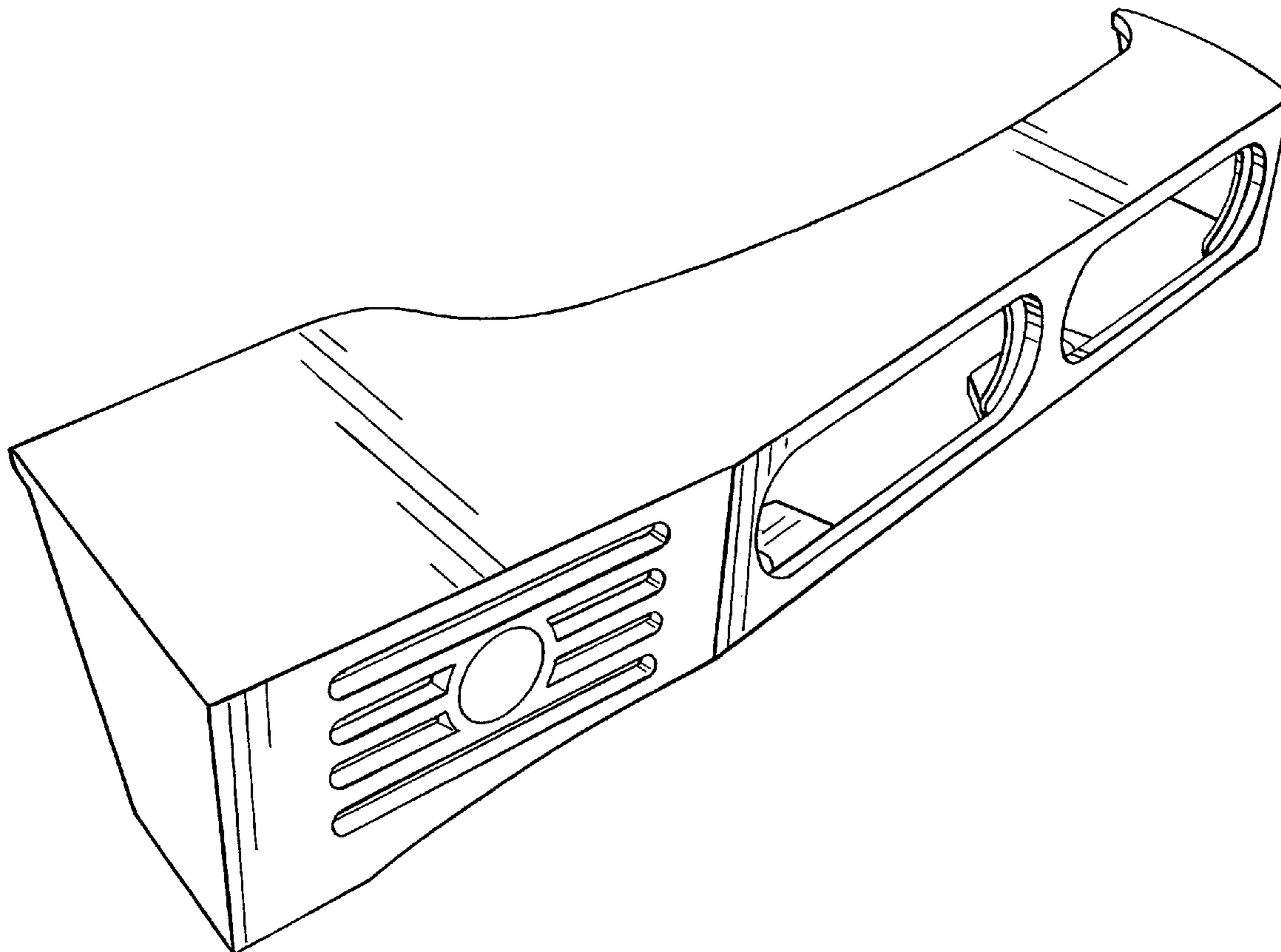

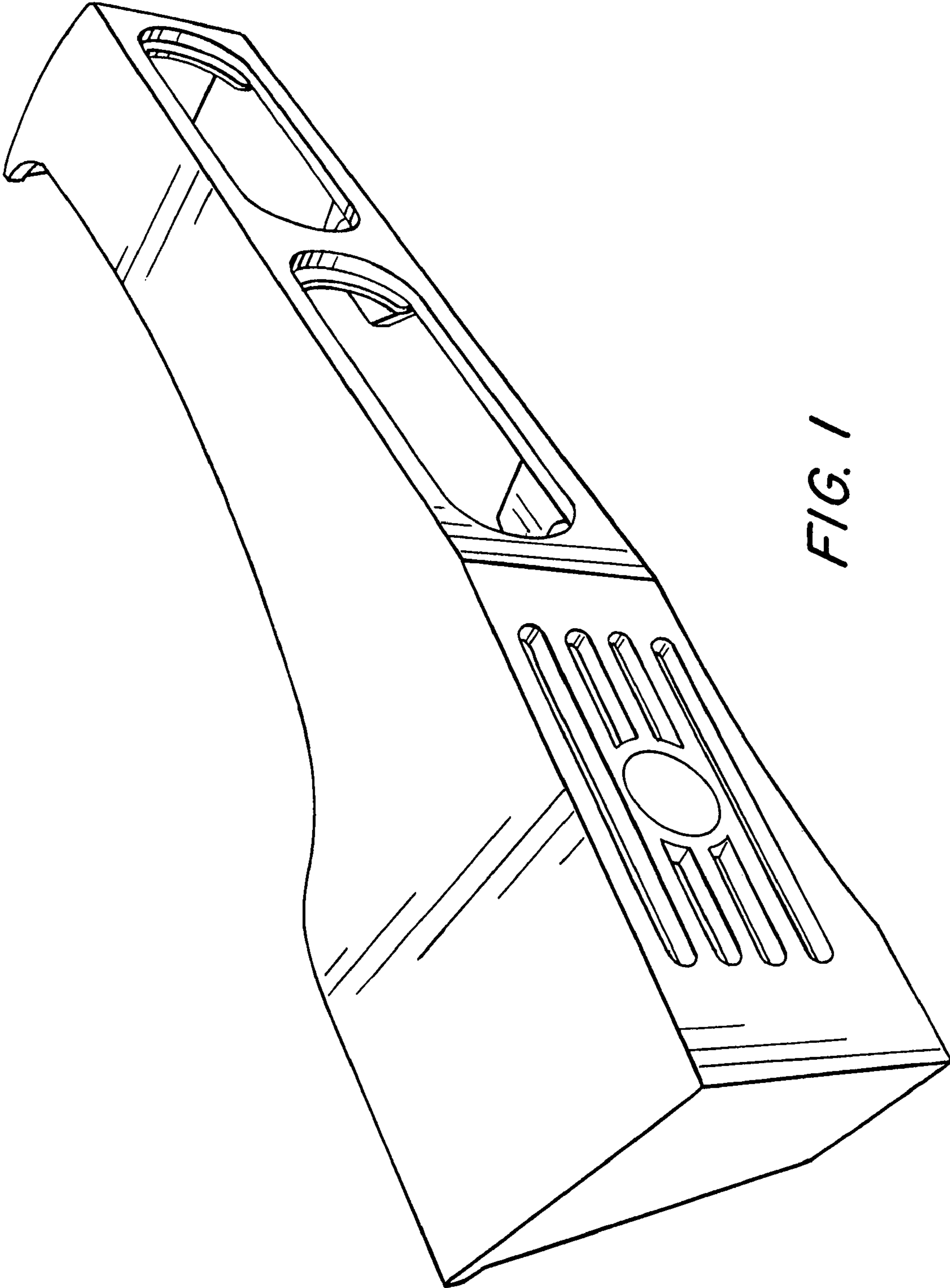

FIG. 1

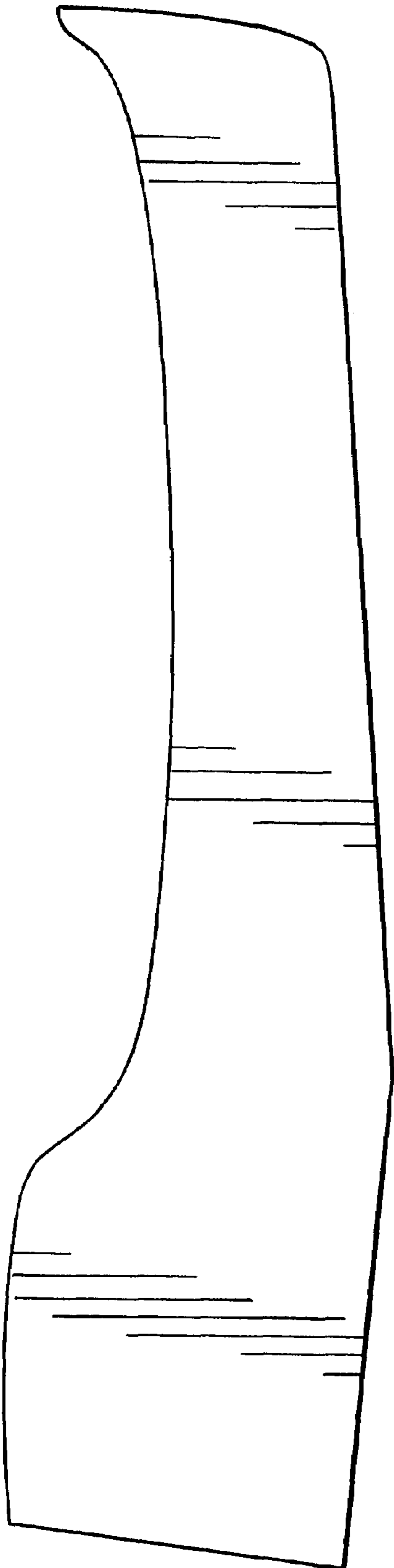

FIG. 2

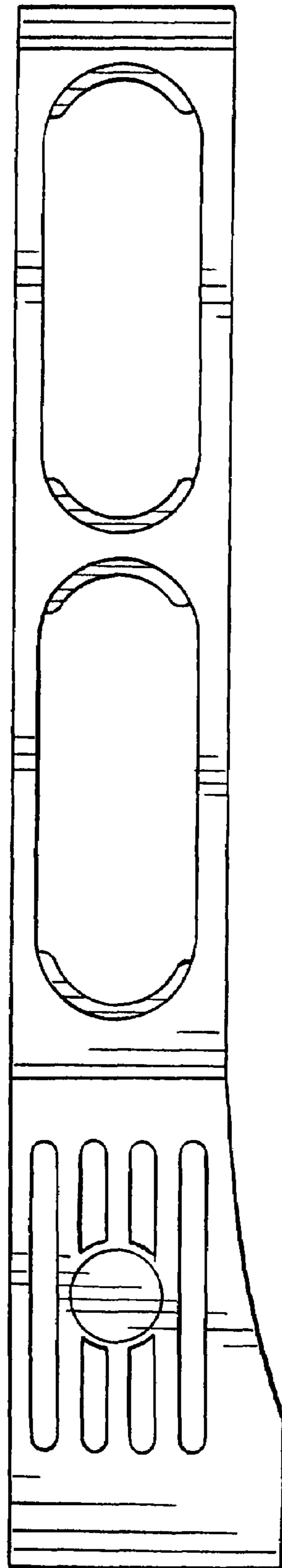

FIG. 3

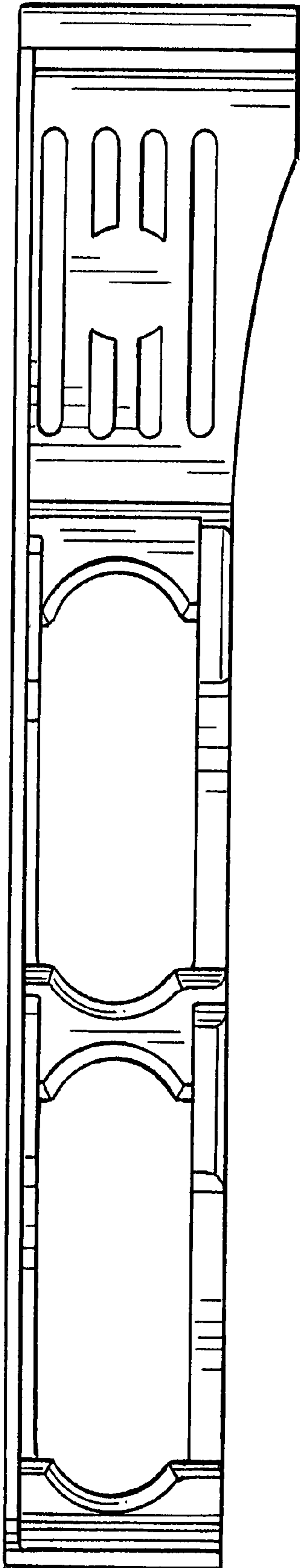
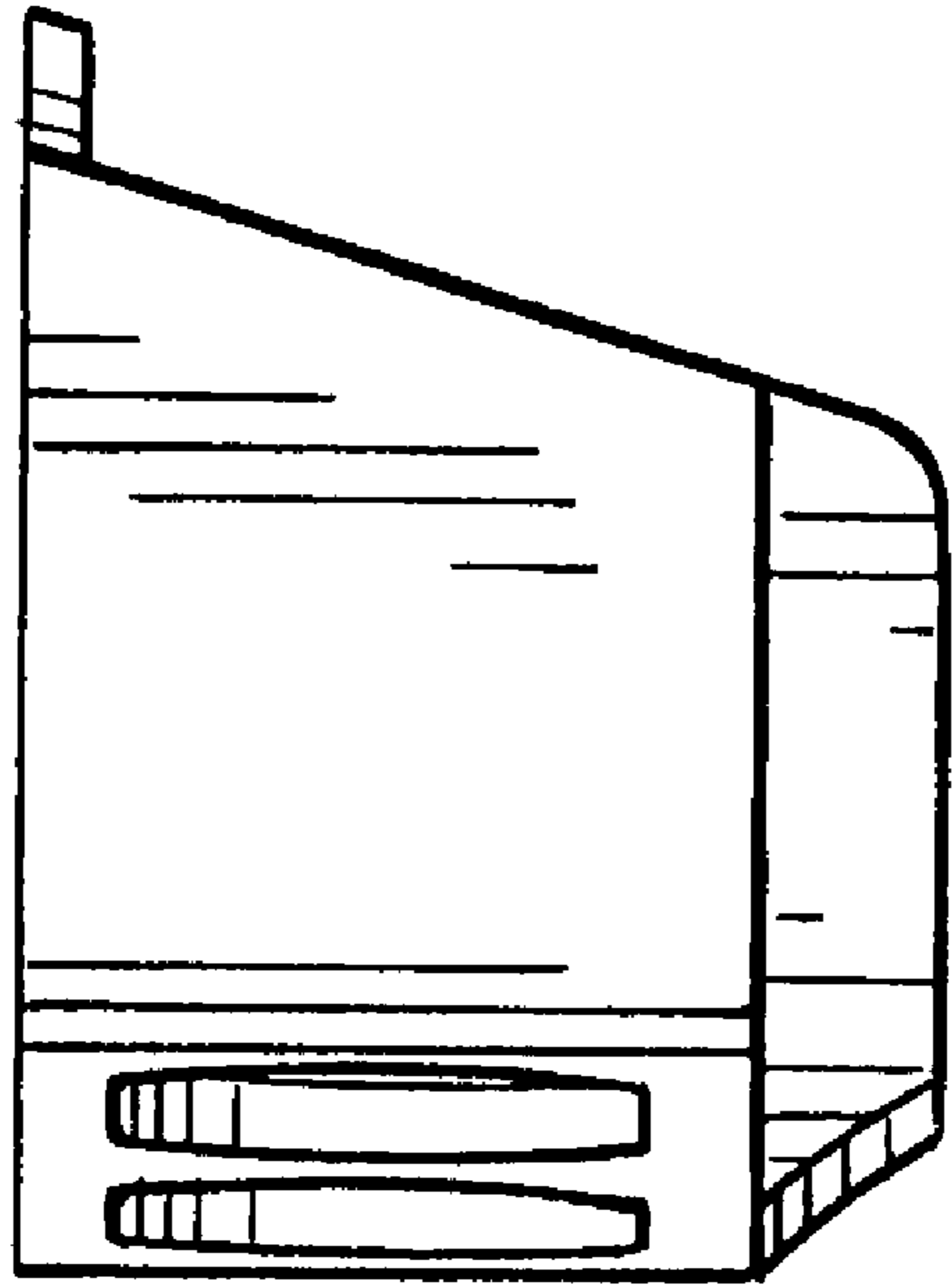

FIG. 4



FIG. 5



*FIG. 7*

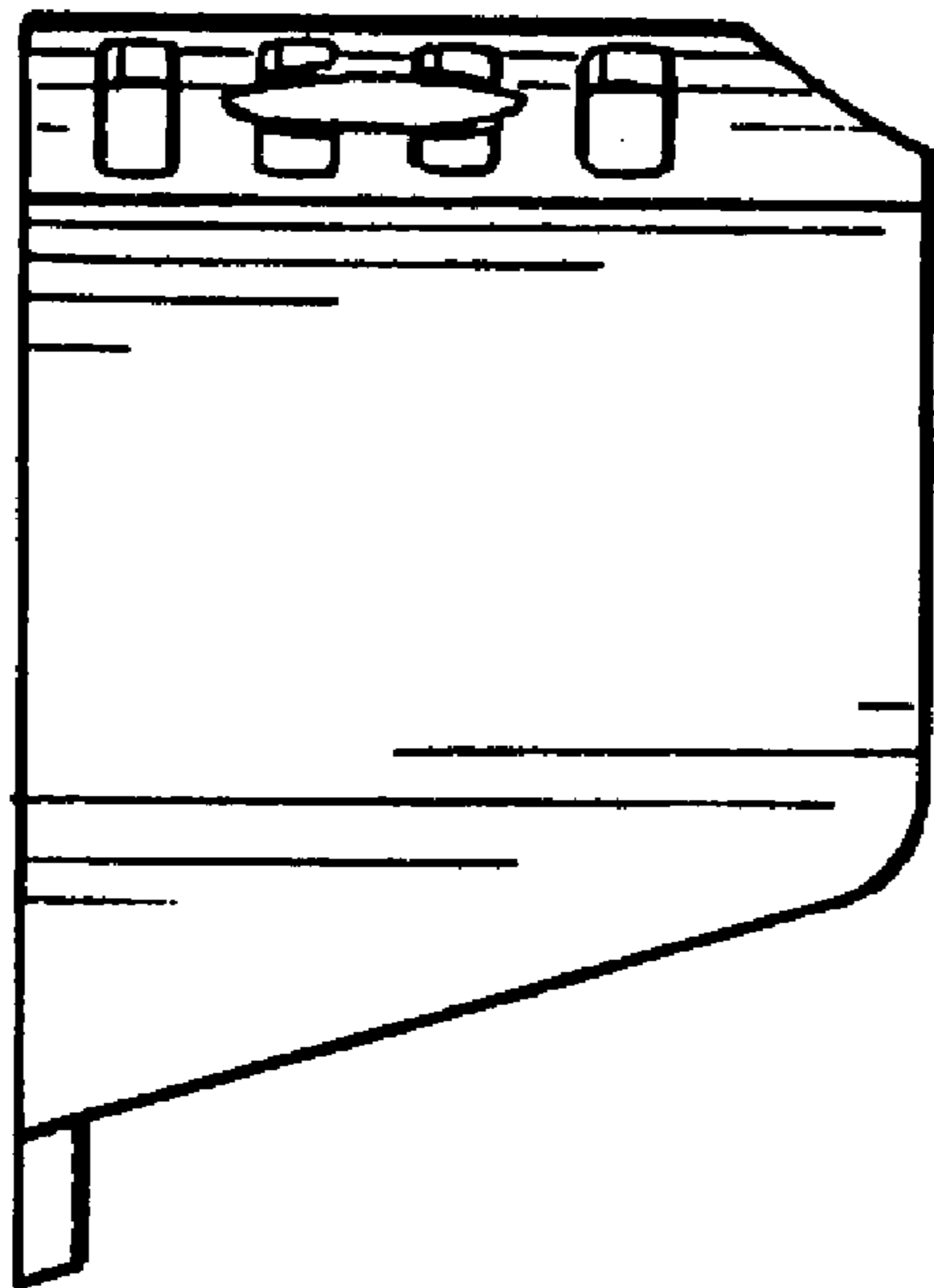

*FIG. 6*