



US00D559977S

(12) **United States Design Patent**  
**Ball**

(10) **Patent No.:** **US D559,977 S**

(45) **Date of Patent:** **\*\* Jan. 15, 2008**

(54) **SWIMMING SNORKEL**

(76) **Inventor:** **Edwin C. Ball**, 8551 - 113B Street,  
Delta, BC (CA) V4C 5G3

(\*\*) **Term:** **14 Years**

(21) **Appl. No.:** **29/247,341**

(22) **Filed:** **Jun. 13, 2006**

(51) **LOC (8) Cl.** ..... **29-02**

(52) **U.S. Cl.** ..... **D24/110.4; D24/110.5**

(58) **Field of Classification Search** ..... D24/110.5,  
D24/110.4, 110; 128/201.11, 201.27, 201.28,  
128/207.11, 206.27, 207.17

See application file for complete search history.

(56) **References Cited**

**U.S. PATENT DOCUMENTS**

D355,691 S *	2/1995	Rasocha	.....	D24/110.5
D406,333 S *	3/1999	Garraffa	.....	D24/110.5
6,302,102 B1 *	10/2001	Giroux et al.	.....	128/201.11
6,318,363 B1 *	11/2001	Monnich	.....	128/201.11
D530,008 S *	10/2006	Mix	.....	D24/110.5

\* cited by examiner

*Primary Examiner*—Ian Simmons

*Assistant Examiner*—Christopher Lee

(74) *Attorney, Agent, or Firm*—Oyen Wiggs Green & Mutala LLP

(57) **CLAIM**

The ornamental design for a swimming snorkel, as shown and described.

**DESCRIPTION**

FIG. 1 is a right rear perspective view of the design;  
FIG. 2 is a left side elevational view of the design, the right side elevational view being a mirror image thereof;  
FIG. 3 is a bottom plan view of the design;  
FIG. 4 is a top plan view of the design;  
FIG. 5 is a front elevational view of the design;  
FIG. 6 is a rear elevational view of the design; and,  
FIG. 7 is a left front perspective view of the design.

**1 Claim, 5 Drawing Sheets**

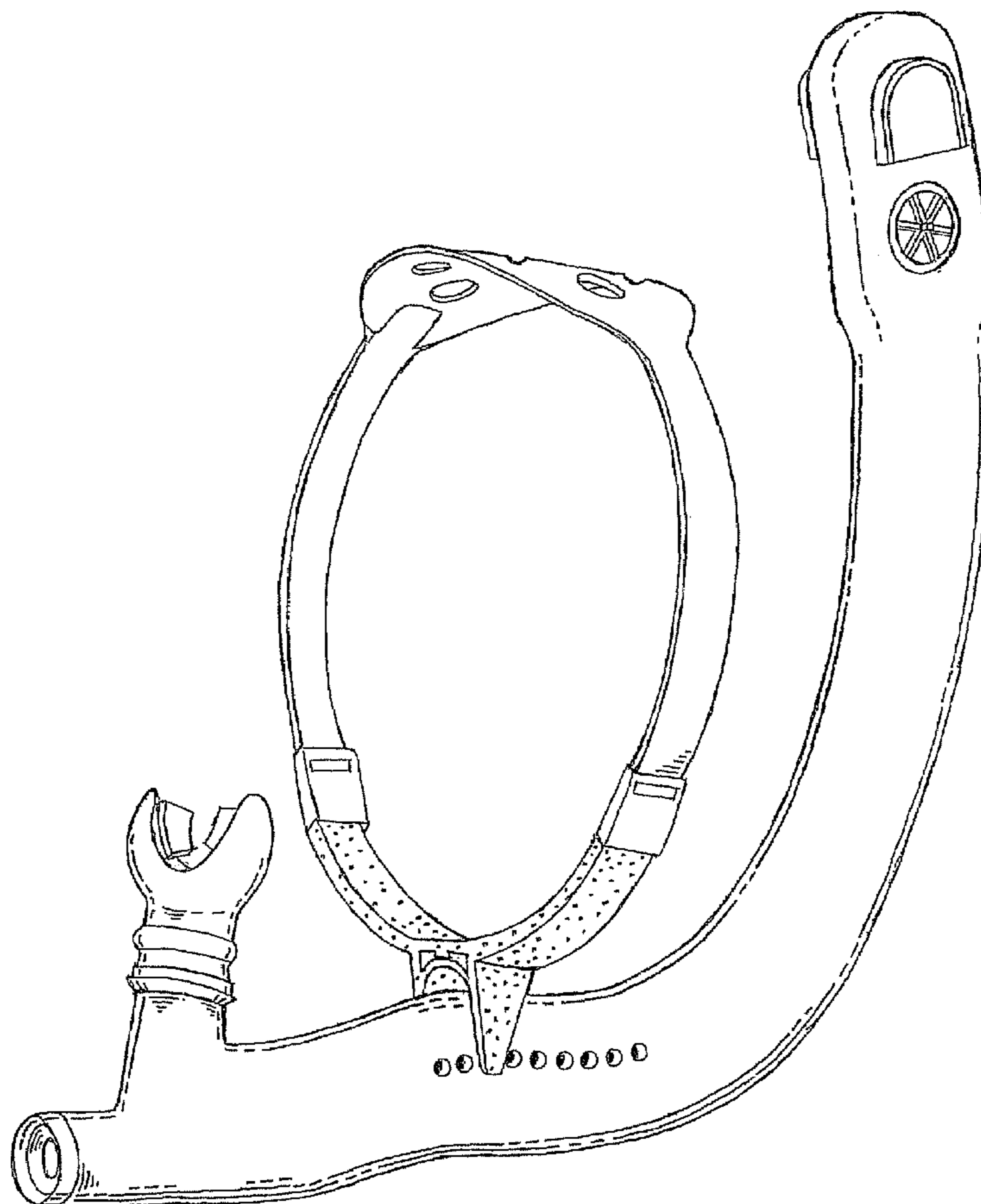

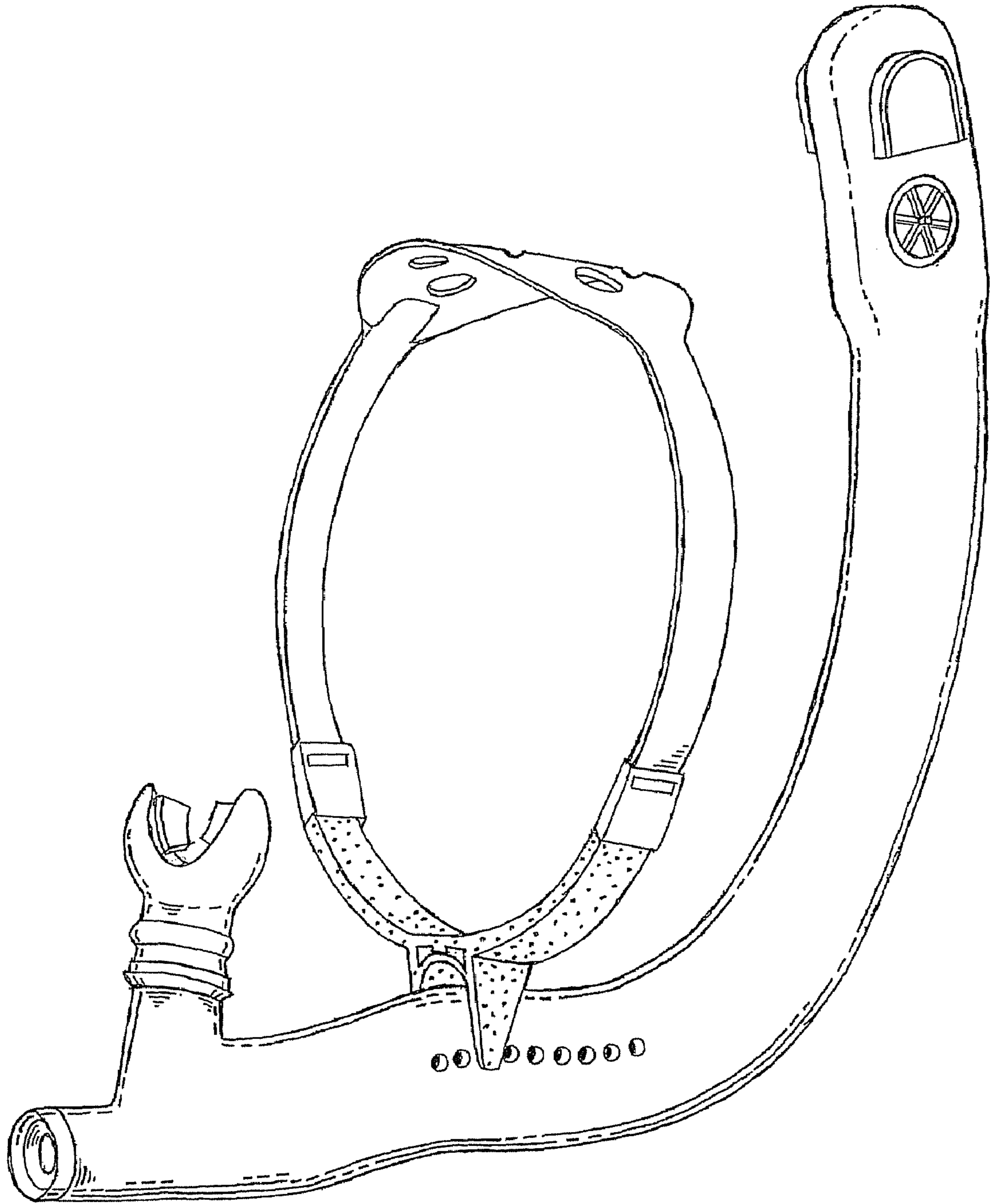

FIG. 1

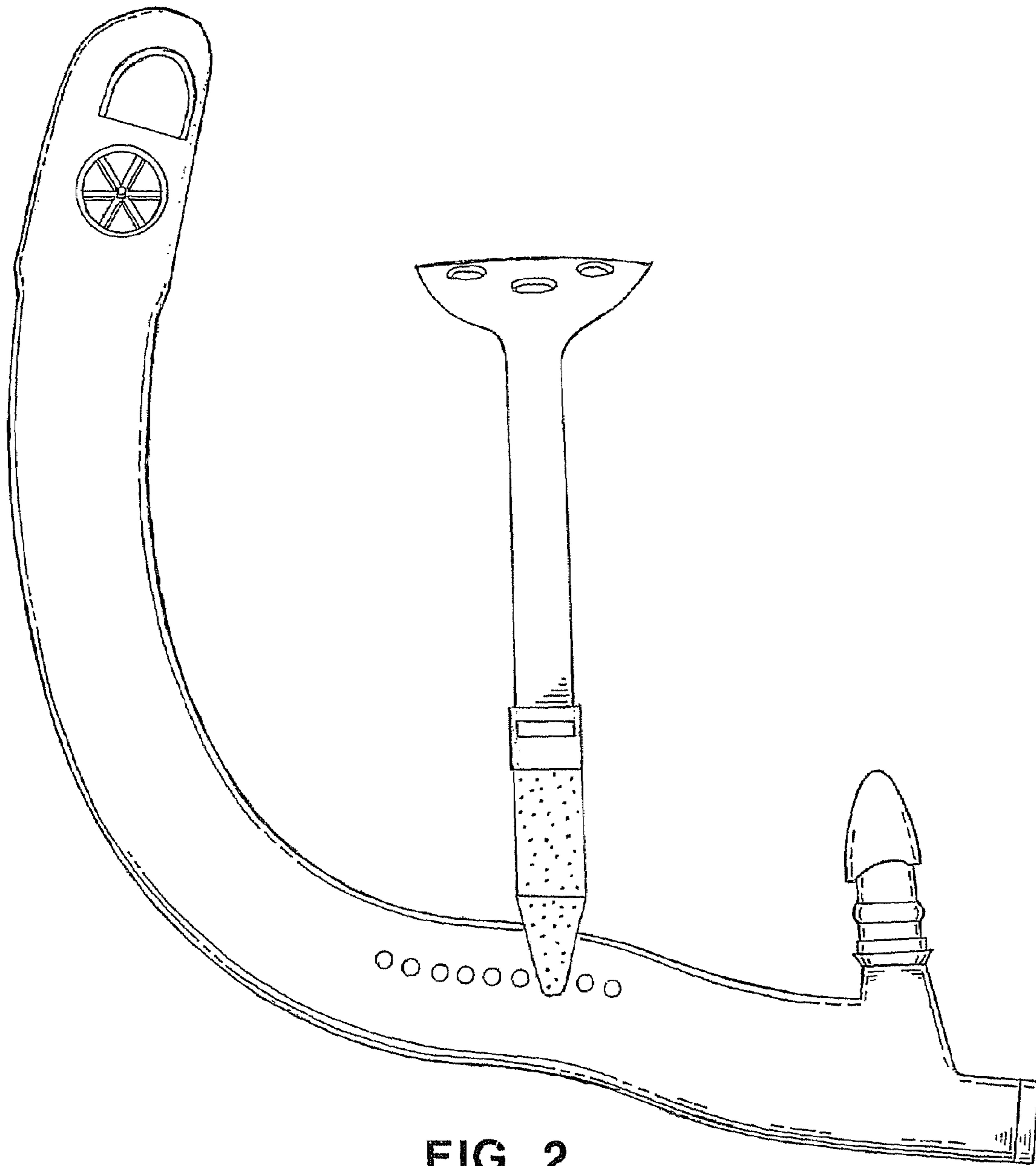

FIG. 2

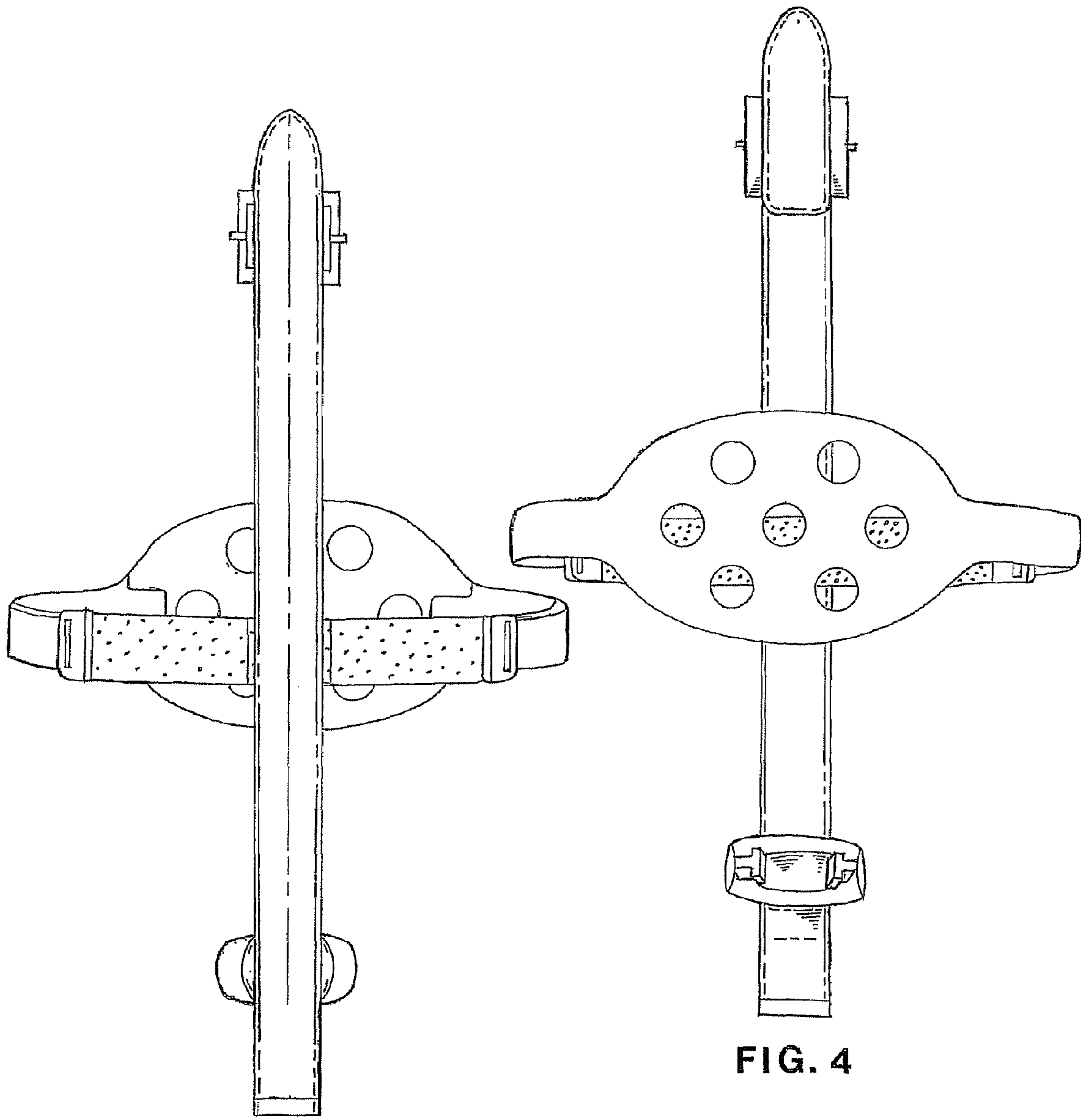

FIG. 3

FIG. 4

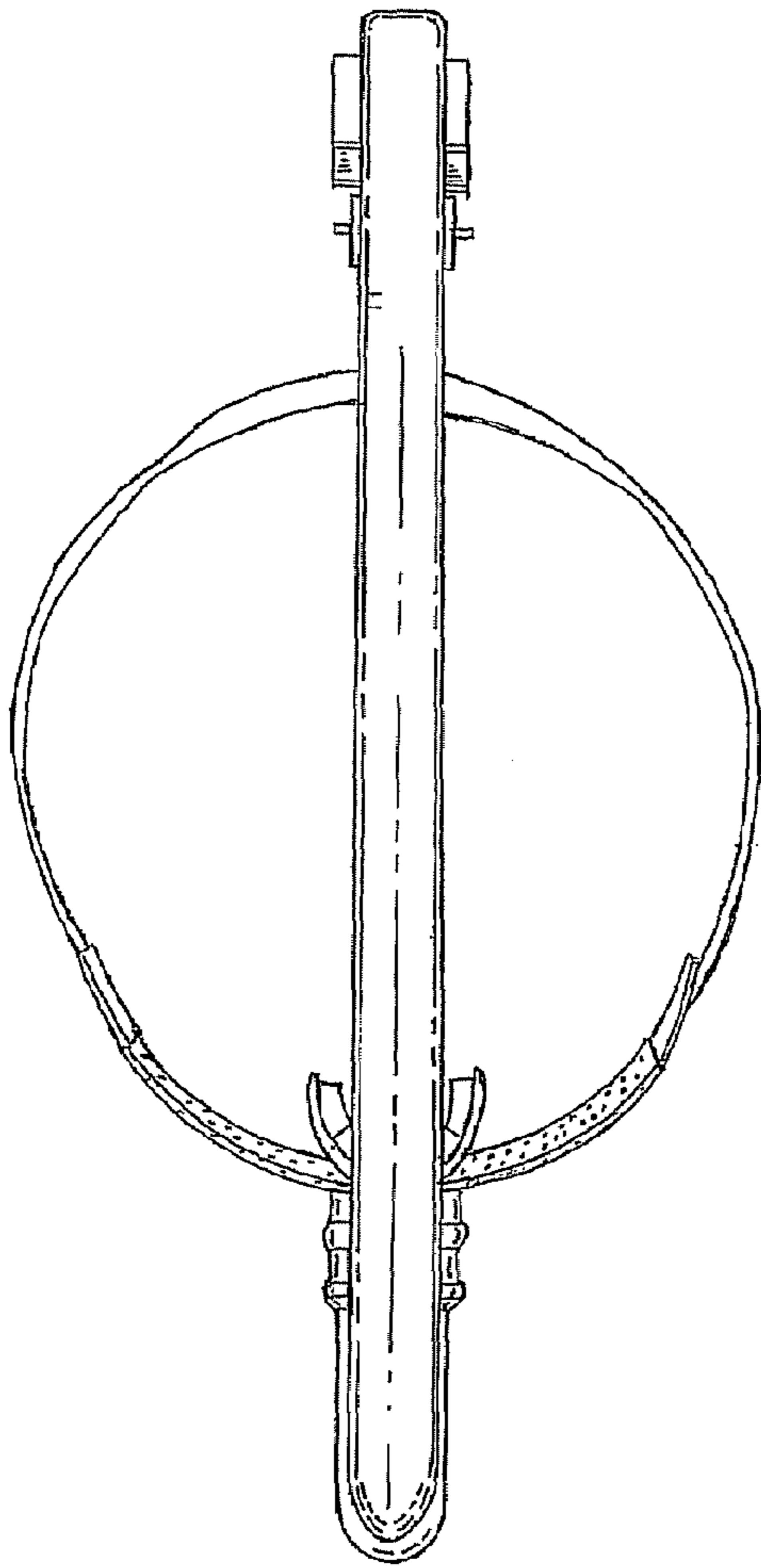

FIG. 5

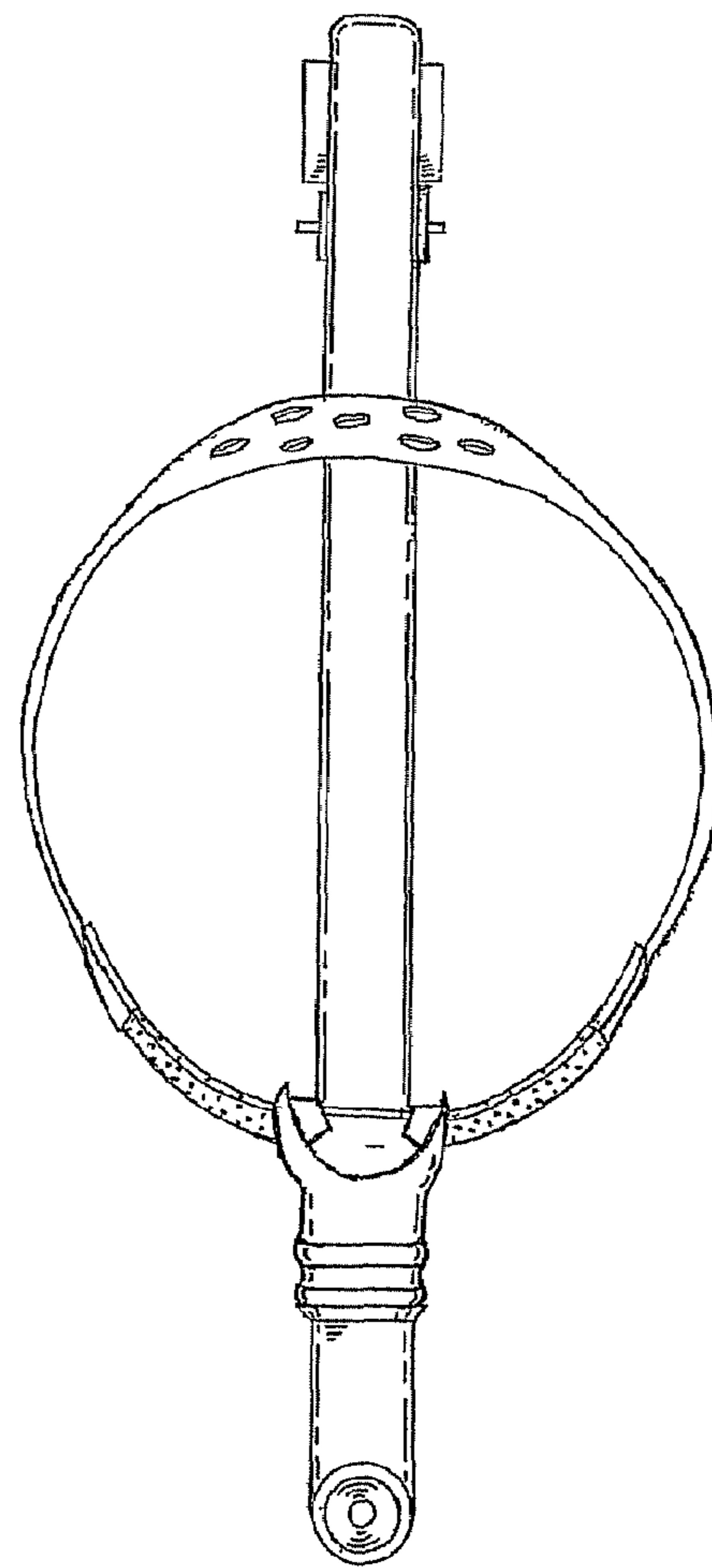

FIG. 6

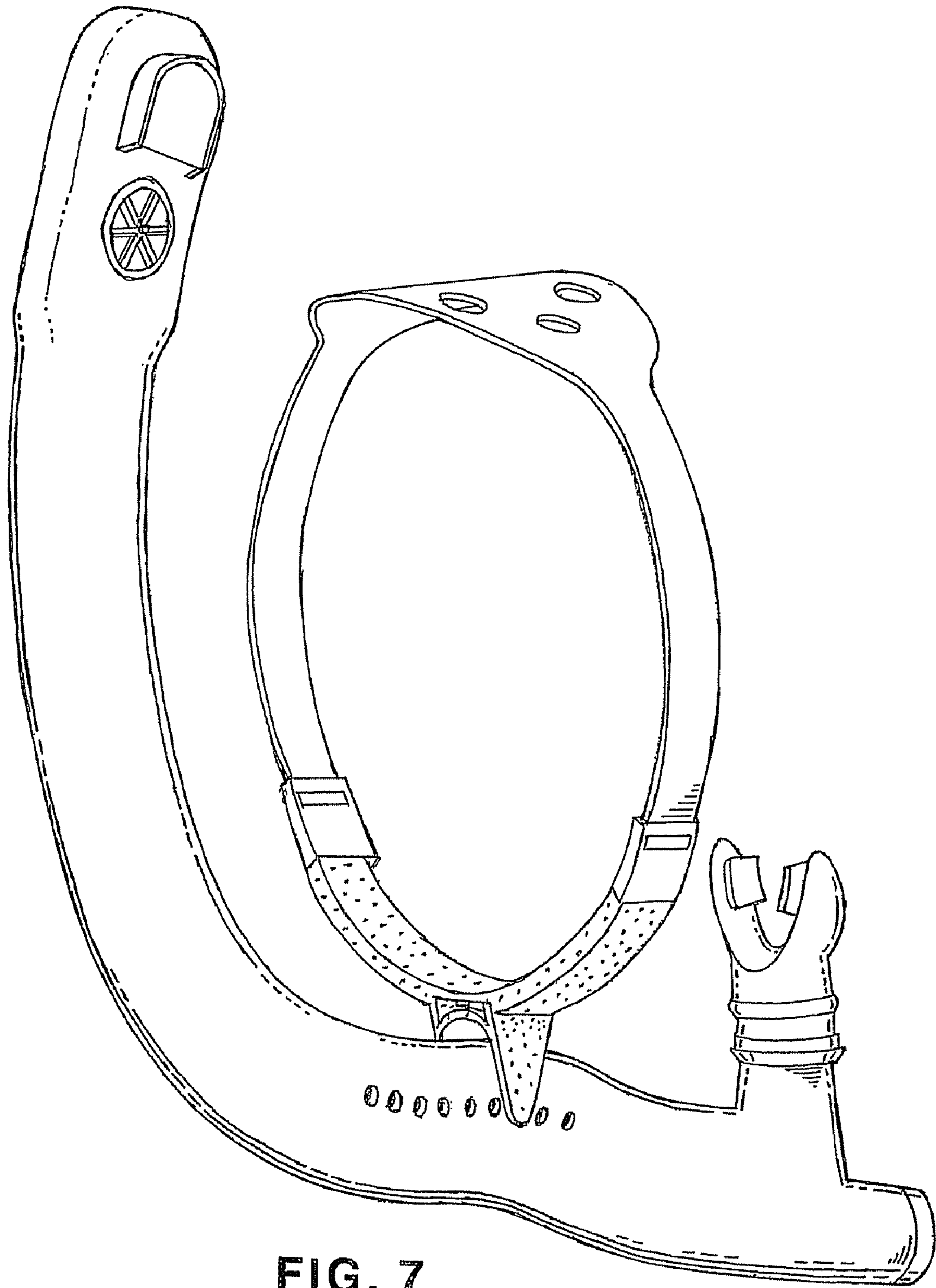

FIG. 7