



US00D559859S

(12) **United States Design Patent**  
**Kim**

(10) **Patent No.:** **US D559,859 S**

(45) **Date of Patent:** **\*\* Jan. 15, 2008**

(54) **PORTABLE DVD PLAYER WITH IPOD**

(75) Inventor: **Maria Kim**, Great Neck, NY (US)

(73) Assignee: **jWin Electronics Corp.**, Port  
Washington, NY (US)

(\*\*) Term: **14 Years**

(21) Appl. No.: **29/258,100**

(22) Filed: **Apr. 17, 2006**

(51) **LOC (8) Cl.** ..... **14-03**

(52) **U.S. Cl.** ..... **D14/496; D14/129**

(58) **Field of Classification Search** ..... D14/496,  
D14/129, 132, 136, 371-375, 126; 345/156,  
345/169, 104, 133, 905; 455/344-351, 11.1,  
455/7, 73; 370/342-344; 368/12; 348/180,  
348/184, 325, 838; 341/12; 720/605, 669,  
720/600, 655; 369/1, 2, 6, 12

See application file for complete search history.

(56) **References Cited**

**U.S. PATENT DOCUMENTS**

6,571,085 B1 \* 5/2003 Sunaga ..... 455/88  
D493,779 S \* 8/2004 Lee ..... D14/156  
D518,019 S \* 3/2006 Ching ..... D14/156  
7,095,867 B2 \* 8/2006 Schul et al. .... 381/334

7,130,251 B1 \* 10/2006 Morohashi ..... 369/47.13  
D532,765 S \* 11/2006 Peng ..... D14/129  
7,155,214 B2 \* 12/2006 Struthers et al. .... 455/422.1  
7,158,376 B2 \* 1/2007 Richardson et al. .... 361/683  
D547,284 S \* 7/2007 Hsiung ..... D14/129  
D548,207 S \* 8/2007 Hsiung ..... D14/129

\* cited by examiner

*Primary Examiner*—Prabhakar Deshmukh

(57) **CLAIM**

The ornamental design for portable DVD player with ipod,  
as shown and described.

**DESCRIPTION**

FIG. 1 is a rear perspective view of a portable DVD player  
with ipod showing my new design;

FIG. 2 is a rear elevational view thereof;

FIG. 3 is a front elevational view thereof;

FIG. 4 is a top plan view thereof;

FIG. 5 is a bottom plan view thereof;

FIG. 6 is a left side elevational view thereof;

FIG. 7 is a right side elevational view thereof; and,

FIG. 8 is a front perspective view thereof.

**1 Claim, 8 Drawing Sheets**

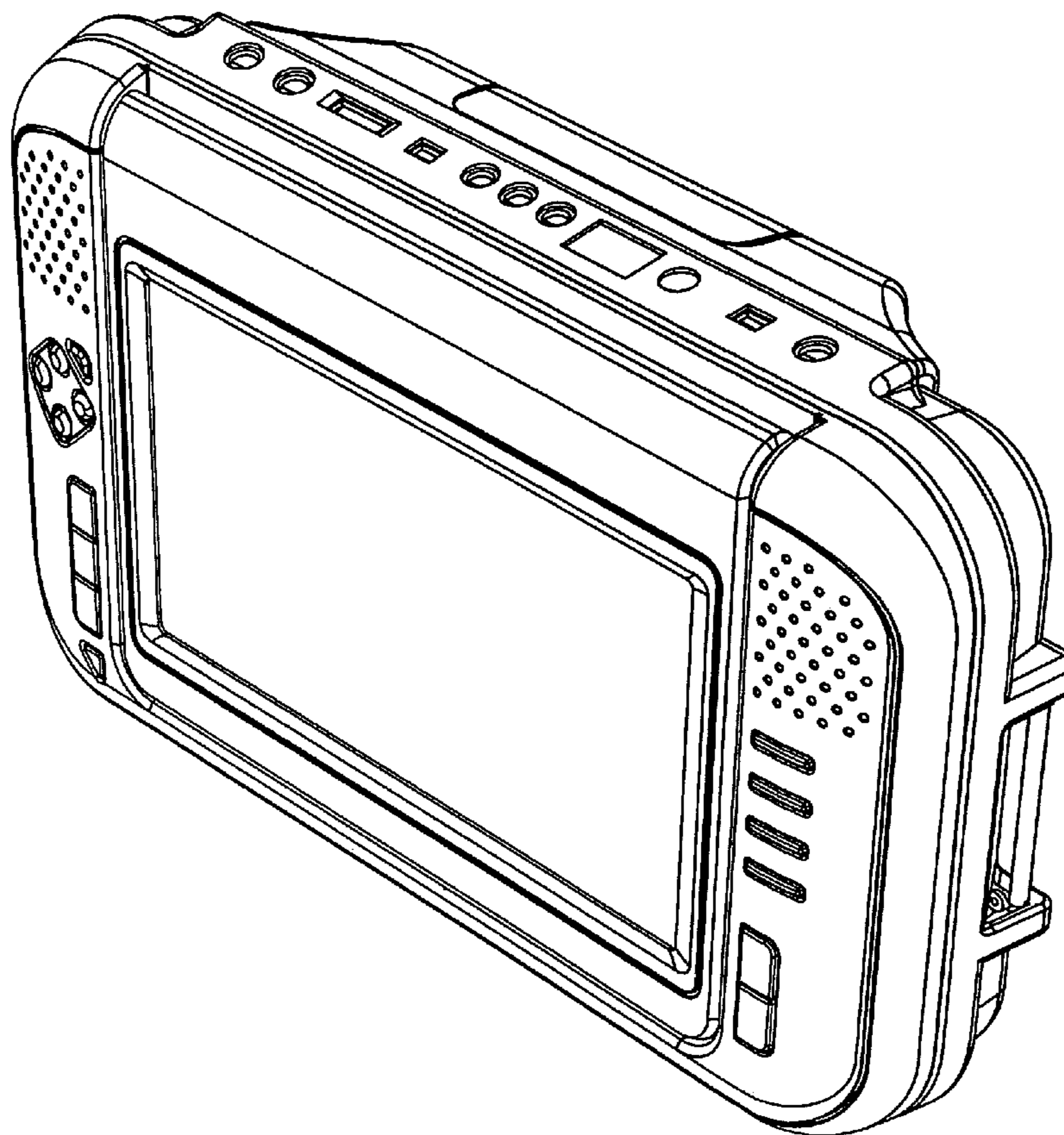

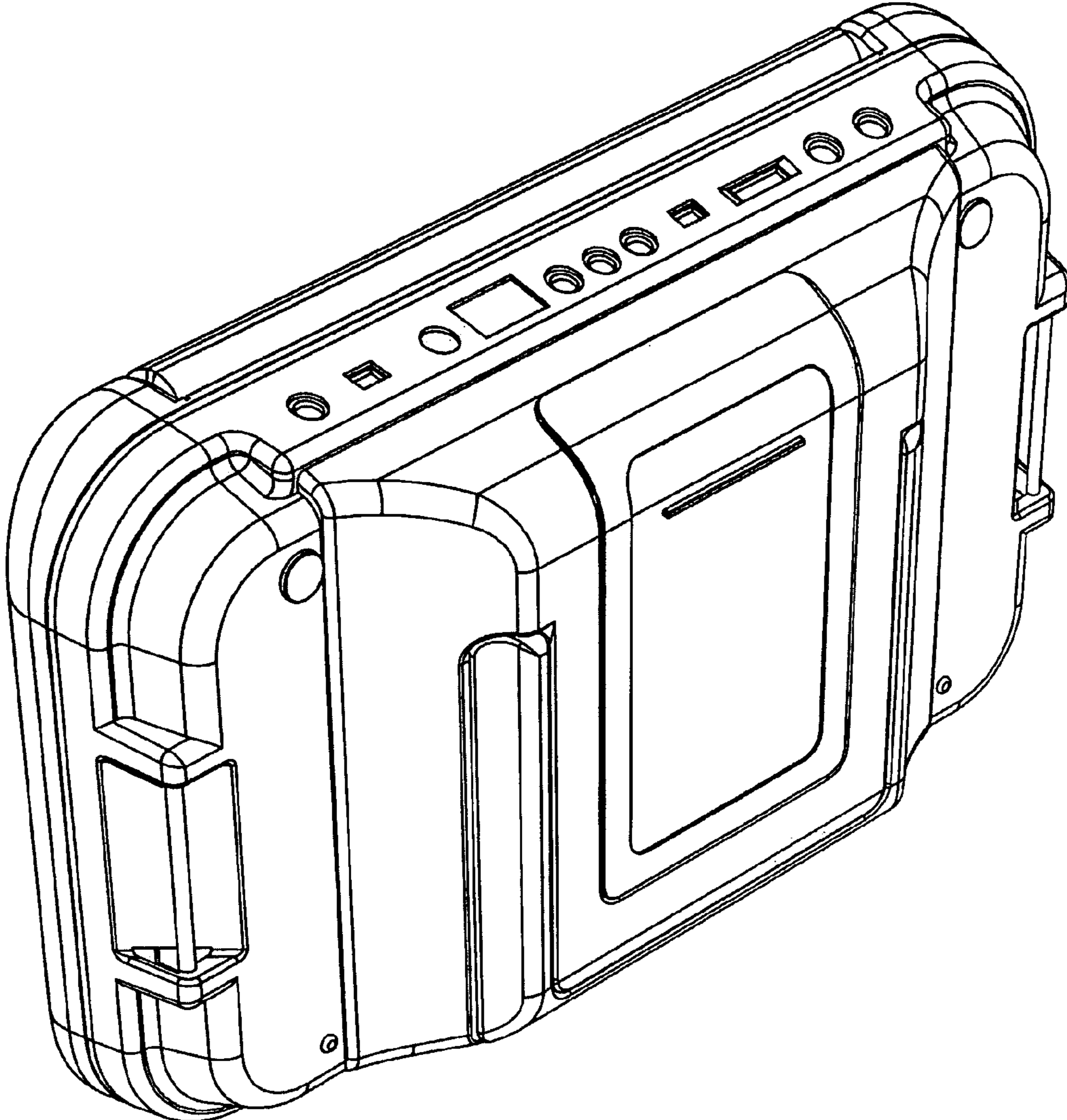

Figure 1

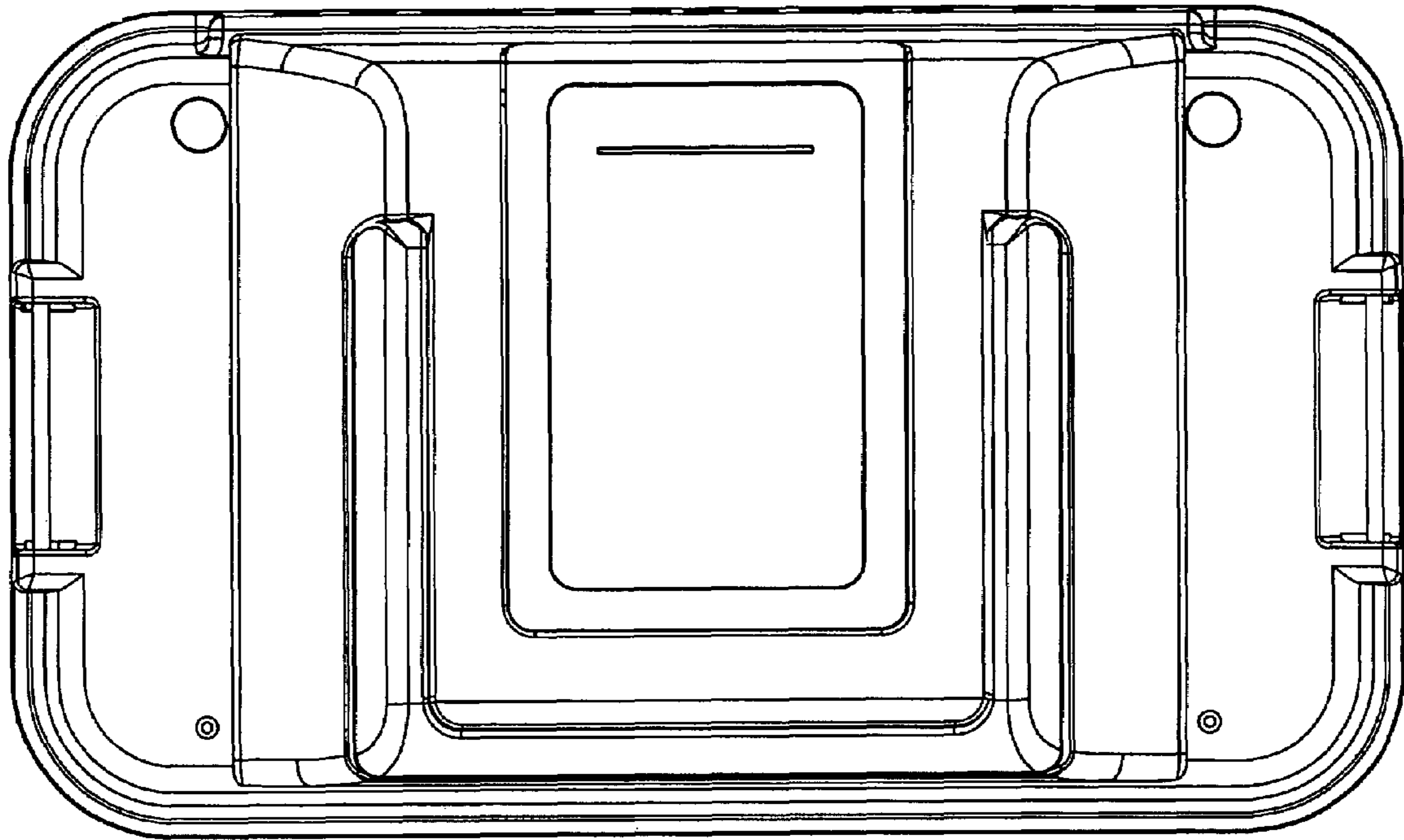

Figure 2

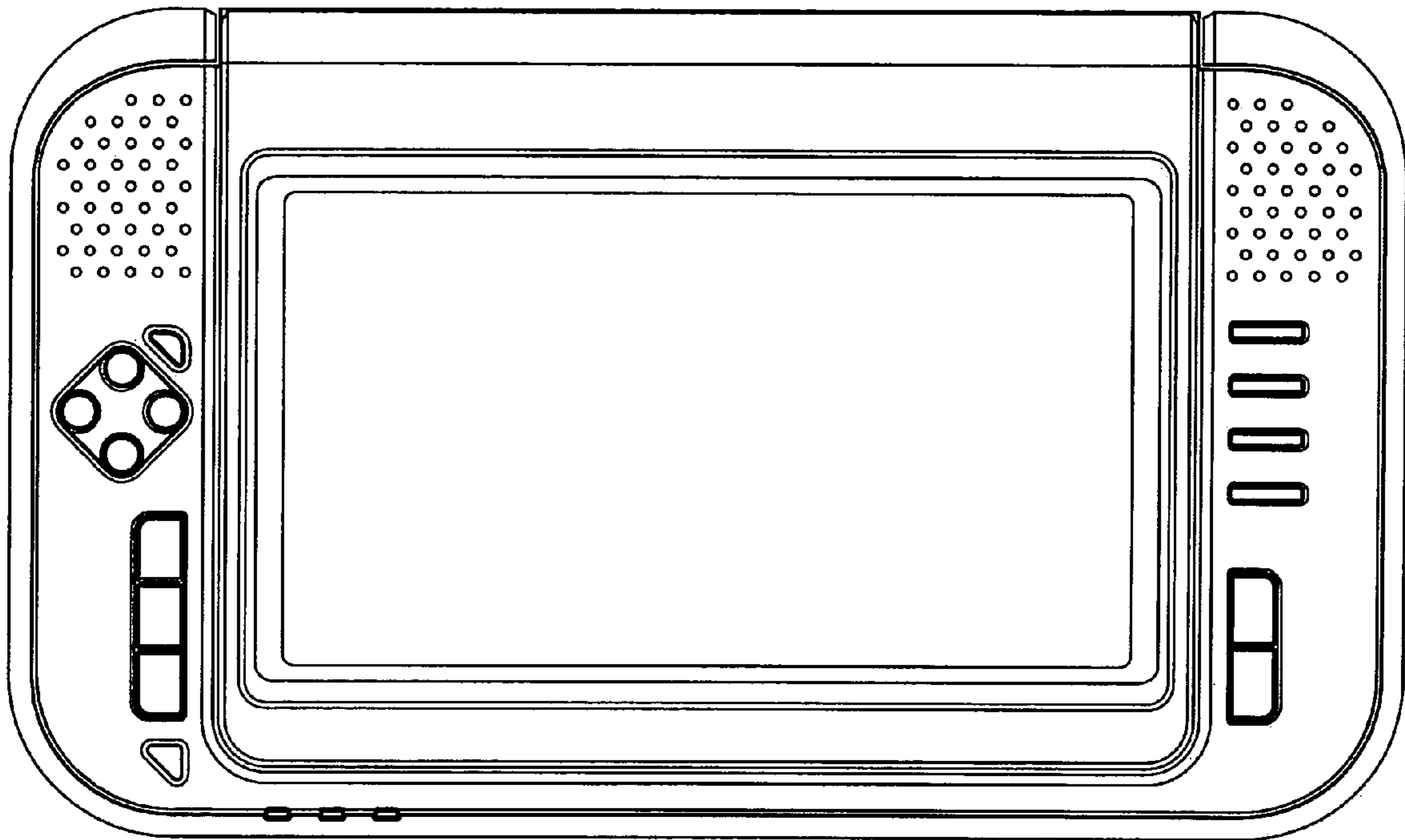

Figure 3

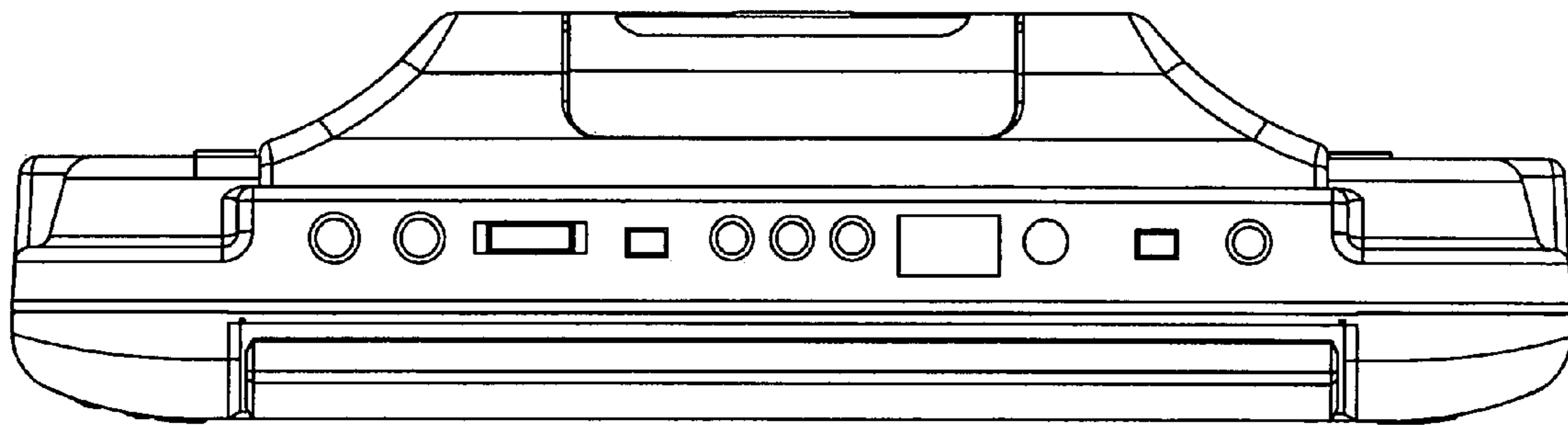

Figure 4

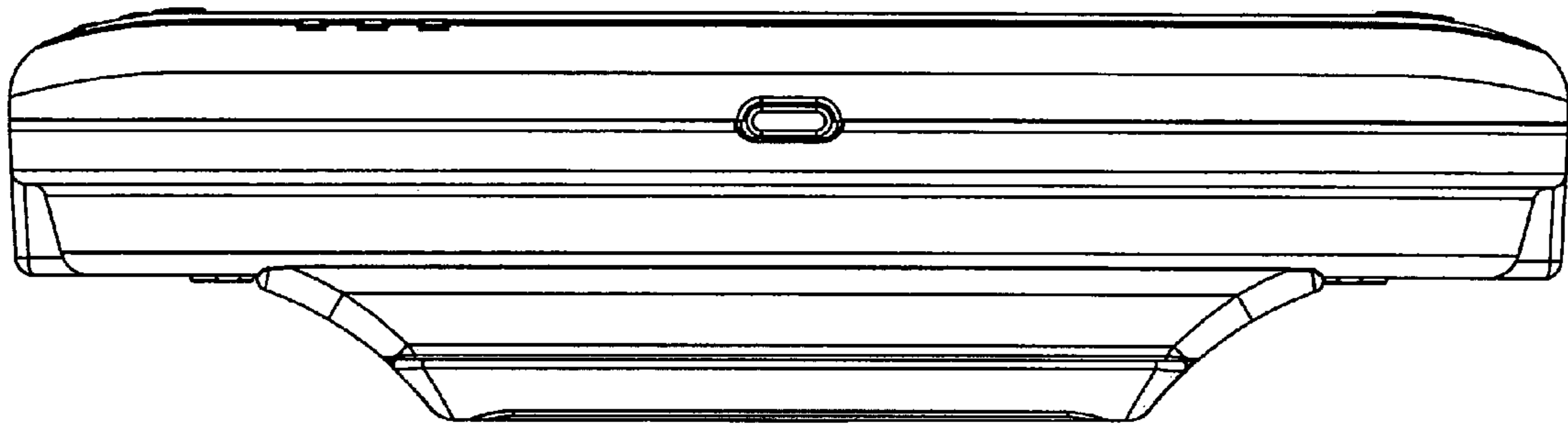

Figure 5

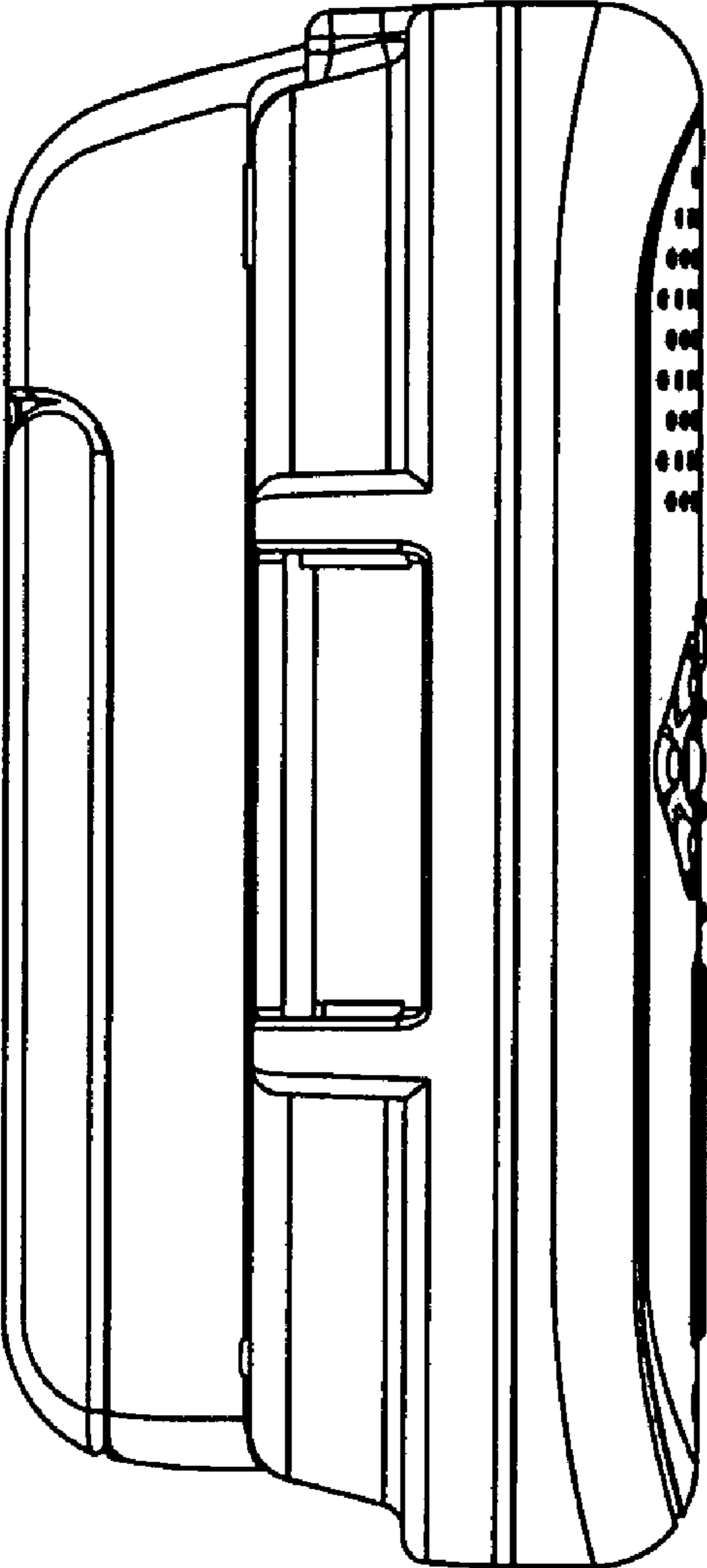

Figure 6

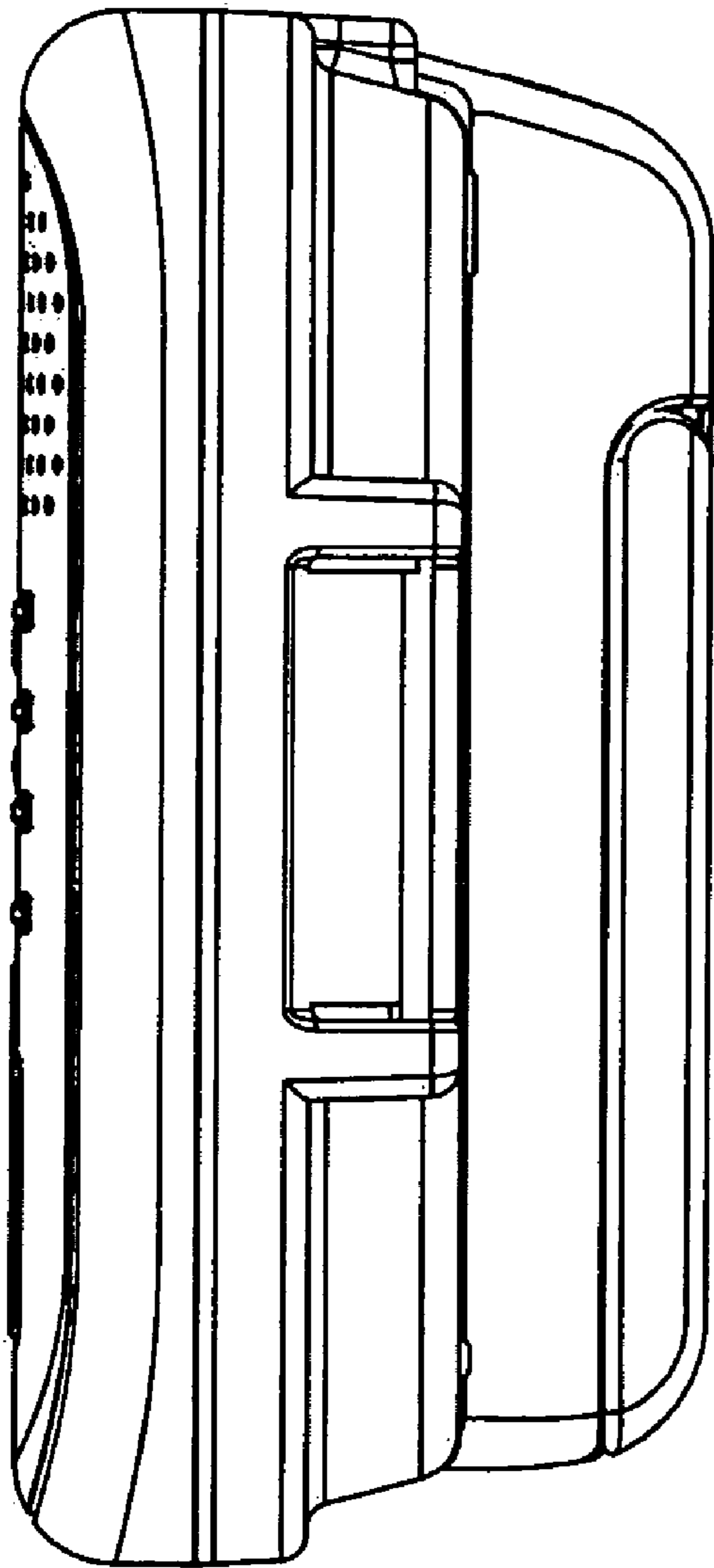

Figure 7



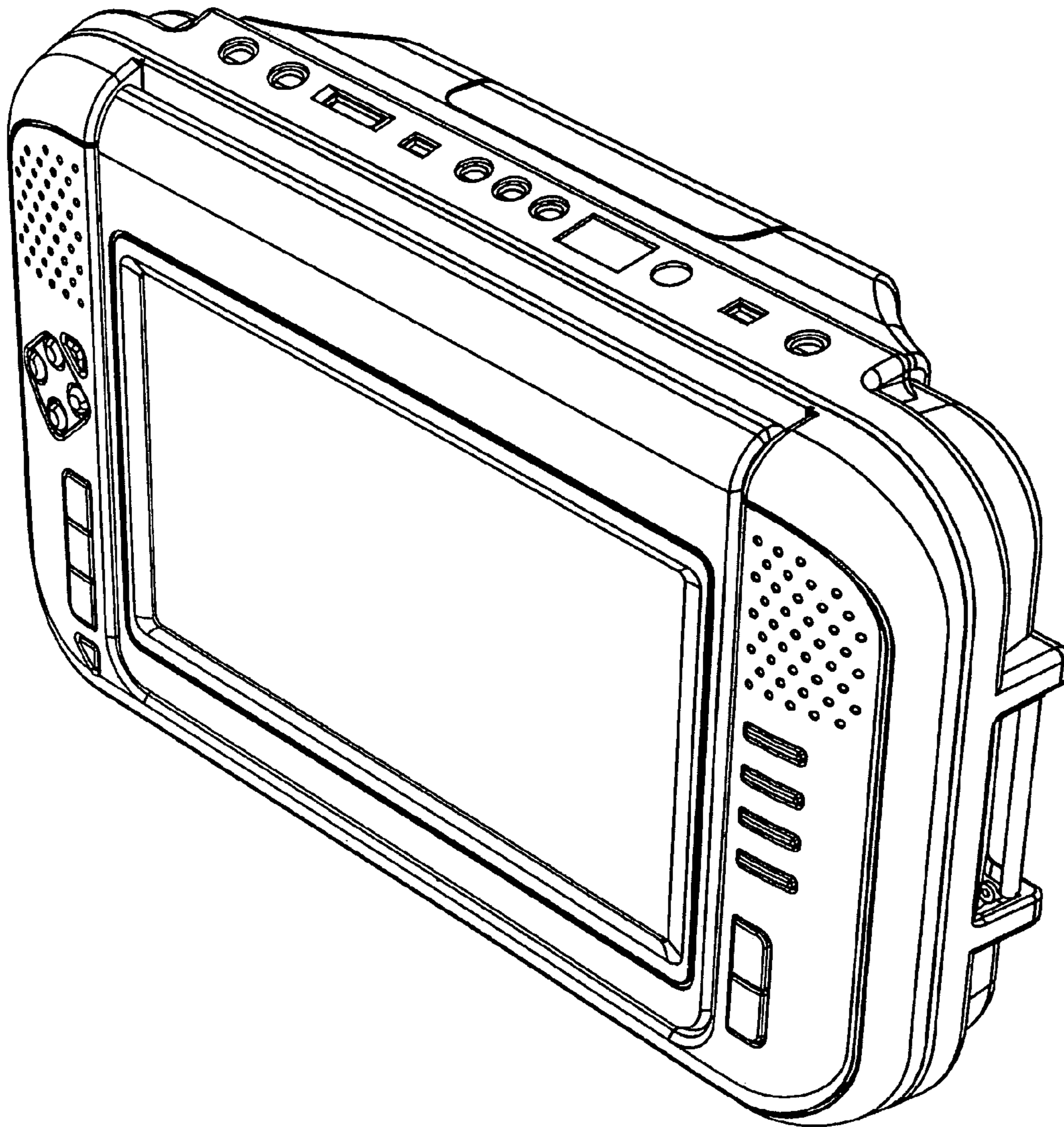

Figure 8