



US00D559825S

(12) **United States Design Patent**
Park et al.

(10) **Patent No.:** **US D559,825 S**
(45) **Date of Patent:** **** Jan. 15, 2008**

(54) **MOBILE PHONE**

(75) Inventors: **Jeil-Sung Park**, Suwon-si (KR);
Min-Hyuk Lee, Gumi-si (KR);
Chang-Hwan Hwang, Goyang-si (KR)

(73) Assignee: **Samsung Electronics Co., Ltd.**,
Suwon-Si (KR)

(**) Term: **14 Years**

(21) Appl. No.: **29/260,473**

(22) Filed: **May 26, 2006**

(30) **Foreign Application Priority Data**

Mar. 7, 2006 (KR) 30-2006-0008237

(51) **LOC (8) Cl.** **14-03**

(52) **U.S. Cl.** **D14/138**

(58) **Field of Classification Search** D14/496,
D14/138, 341-347; 455/575.3, 575.1; D21/517,
D21/329, 333

See application file for complete search history.

(56) **References Cited**

U.S. PATENT DOCUMENTS

D486,132 S *	2/2004	Jang	D14/138
D488,454 S *	4/2004	Lee	D14/138
D496,016 S *	9/2004	Hoo	D14/138
D497,353 S *	10/2004	Kim et al.	D14/138
D498,468 S *	11/2004	Seo	D14/138
D507,551 S *	7/2005	Kim et al.	D14/138
D521,480 S *	5/2006	Ou et al.	D14/138
D525,224 S *	7/2006	Pitt et al.	D14/138
D536,320 S *	2/2007	Michaels	D14/138
D543,172 S *	5/2007	Lee et al.	D14/138
7,212,845 B2 *	5/2007	Ikeuchi	455/575.3
D544,852 S *	6/2007	Takamori et al.	D14/138
D546,307 S *	7/2007	Lee	D14/138
2003/0125079 A1 *	7/2003	Park et al.	455/556
2004/0142721 A1 *	7/2004	Kim	455/550.1
2004/0224730 A1 *	11/2004	Sakai et al.	455/575.3

2005/0245296 A1 *	11/2005	Hong et al.	455/575.3
2005/0261040 A1 *	11/2005	Andersson et al.	455/575.3
2006/0019728 A1 *	1/2006	Sakamoto et al.	455/575.3
2006/0135225 A1 *	6/2006	Lin et al.	455/575.3
2006/0135226 A1 *	6/2006	Won et al.	455/575.3

OTHER PUBLICATIONS

Samsung Z620 telephone, announced Aug. 2006, [online], [retrieved on Jul. 19, 2007]. Retrieved from Internet , <URL: <http://www.gsmarena.com>>.*

Samsung E870 telephone, announced 1st quarter 2006, [online], [retrieved on Jul. 19, 2007]. Retrieved from Internet , <URL: <http://www.gsmarena.com>>.*

Samsung A500 telephone, announced 2002, [online], [retrieved on Jul. 19, 2007]. Retrieved from Internet , <URL: <http://www.gsmarena.com>>.*

Sharp 903 telephone, announced Jul. 2005, [online], [retrieved on Jul. 19, 2007]. Retrieved from Internet , <URL: <http://www.gsmarena.com>>.*

* cited by examiner

Primary Examiner—Jeffrey Asch

(74) *Attorney, Agent, or Firm*—Staas & Halsey LLP

(57) **CLAIM**

The ornamental design for the mobile phone, as shown and described.

DESCRIPTION

FIG. 1 is a perspective view of the mobile phone showing our design;

FIG. 2 is a front view thereof;

FIG. 3 is a rear view thereof;

FIG. 4 is a left side view thereof;

FIG. 5 is a right side view thereof;

FIG. 6 is a top plan view thereof;

FIG. 7 is a bottom plan view thereof; and,

FIG. 8 is a perspective, open view thereof.

1 Claim, 3 Drawing Sheets

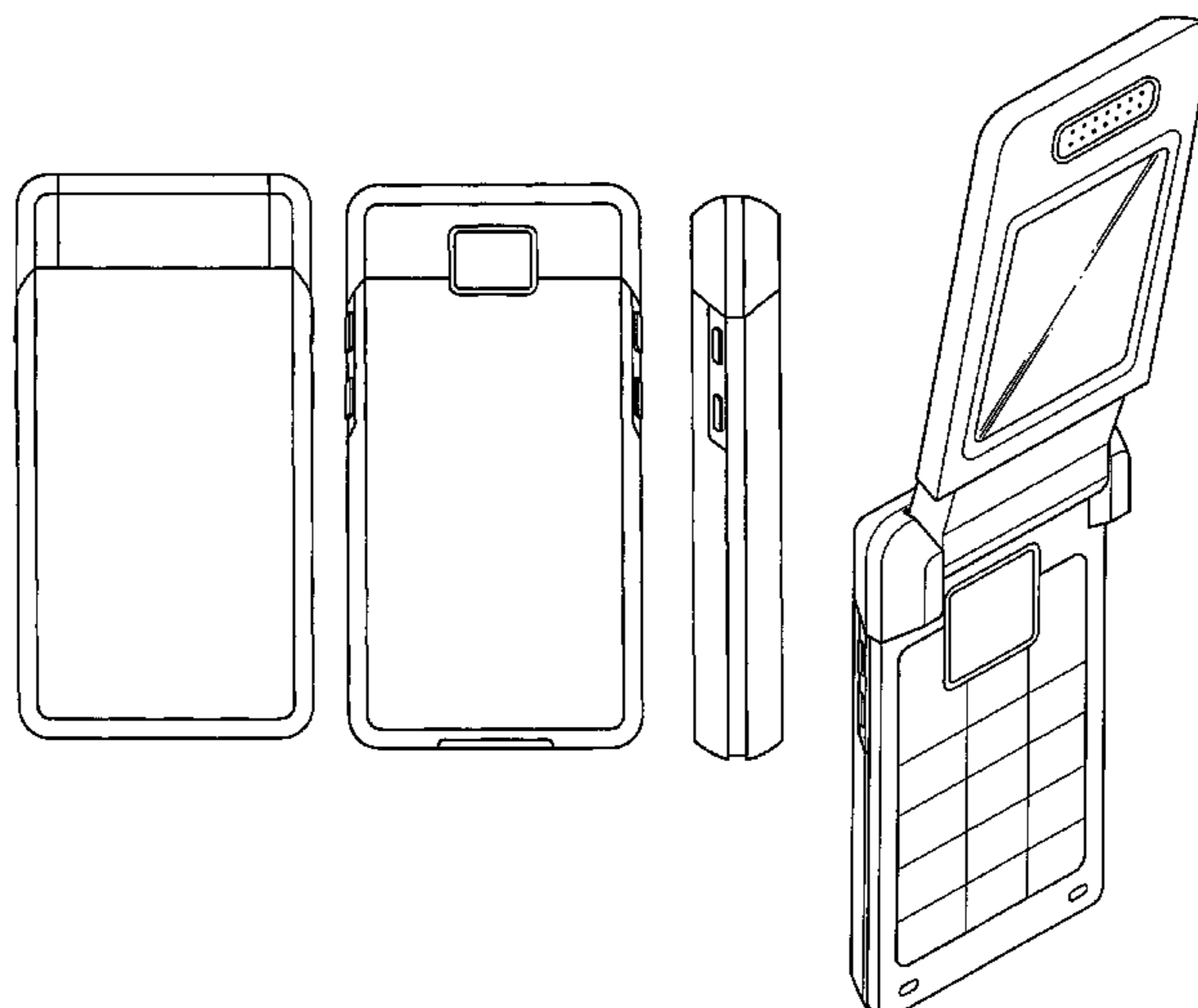

FIG. 1

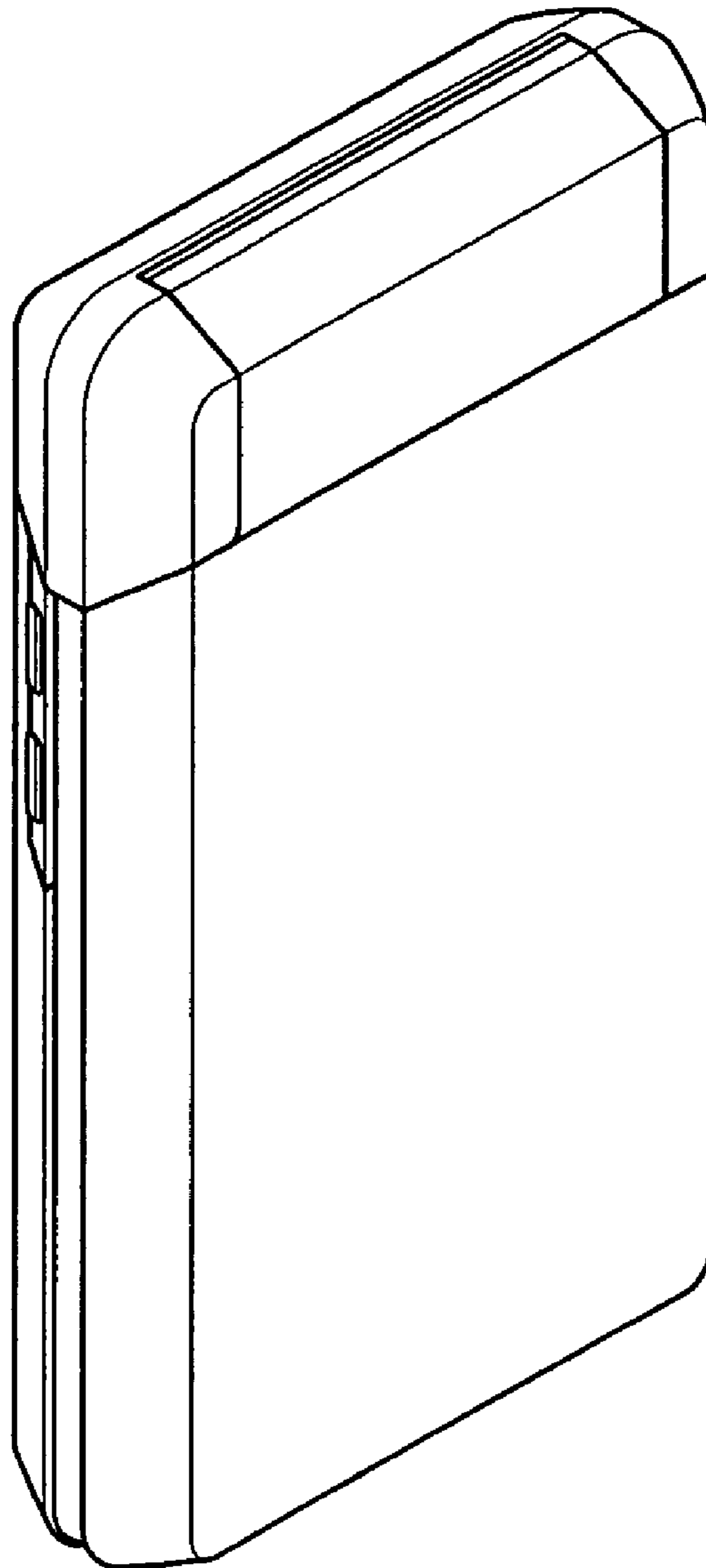

FIG.2

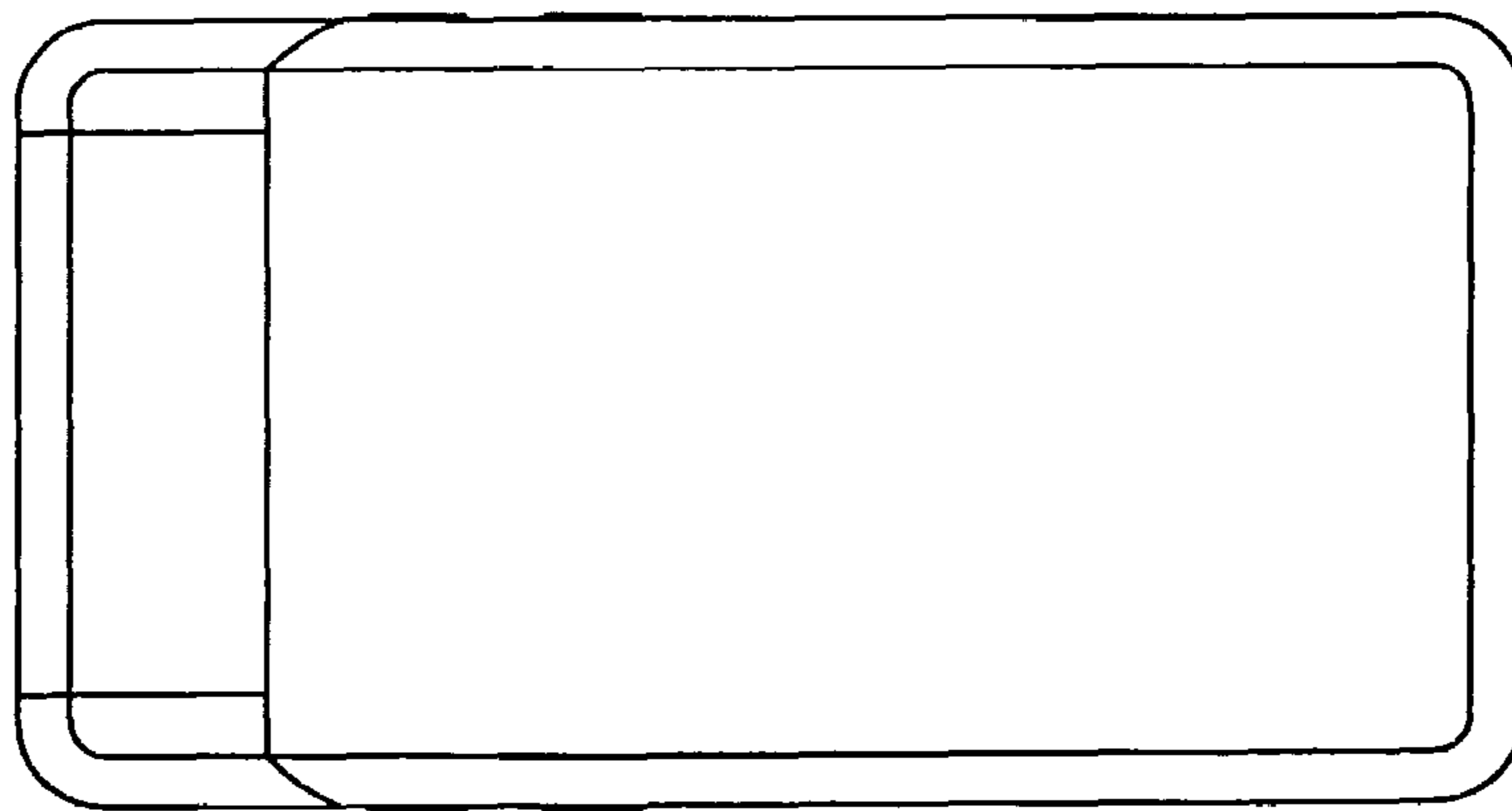

FIG.3

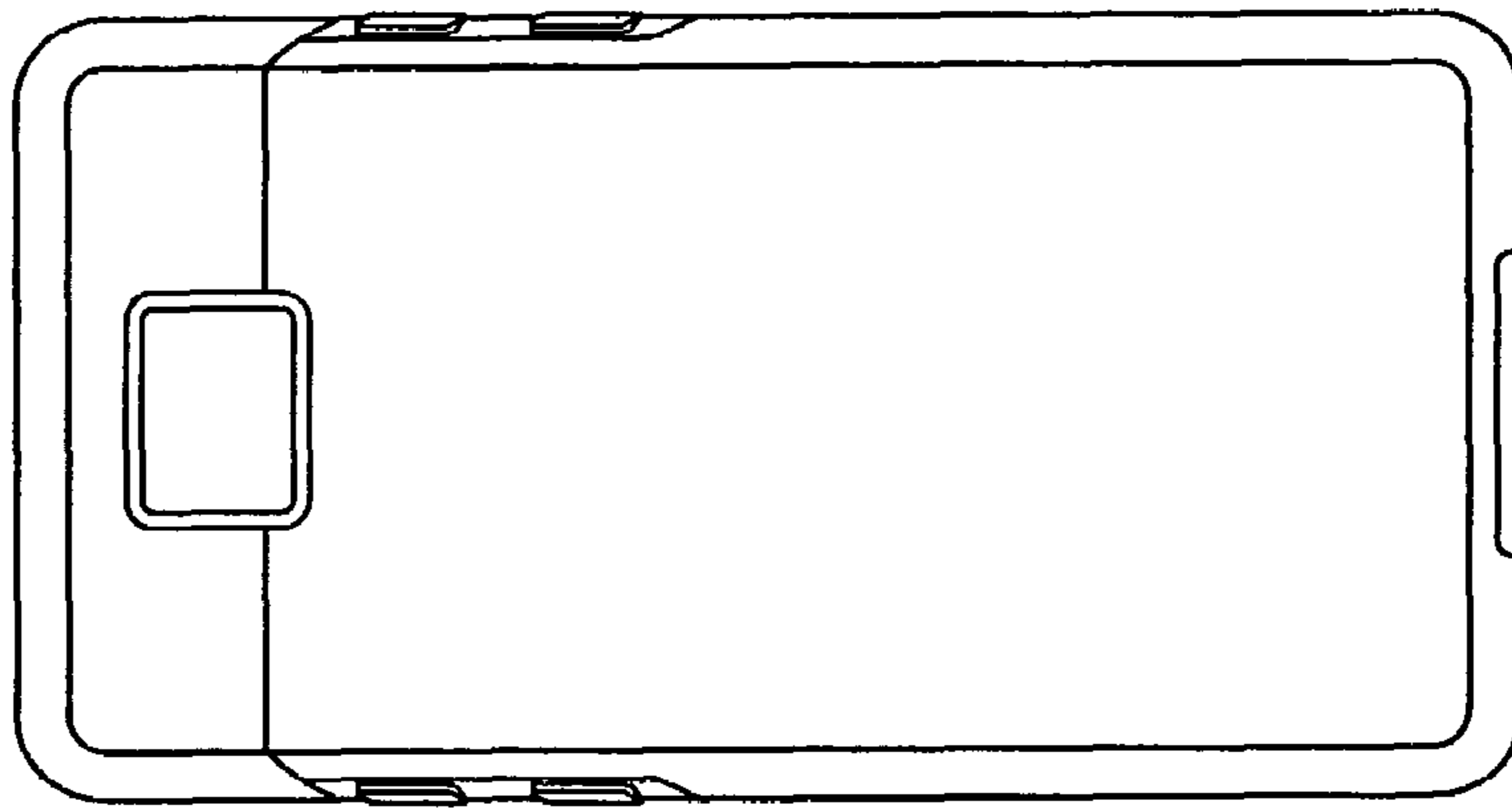

FIG.4

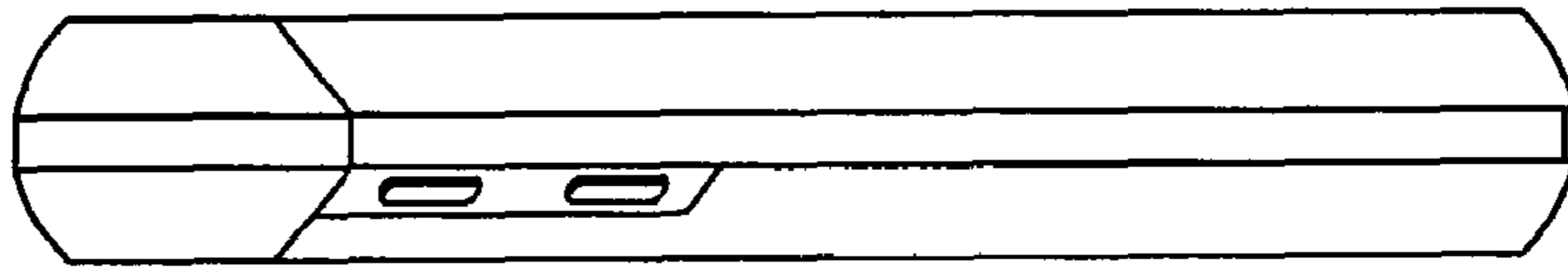

FIG.5



FIG. 6

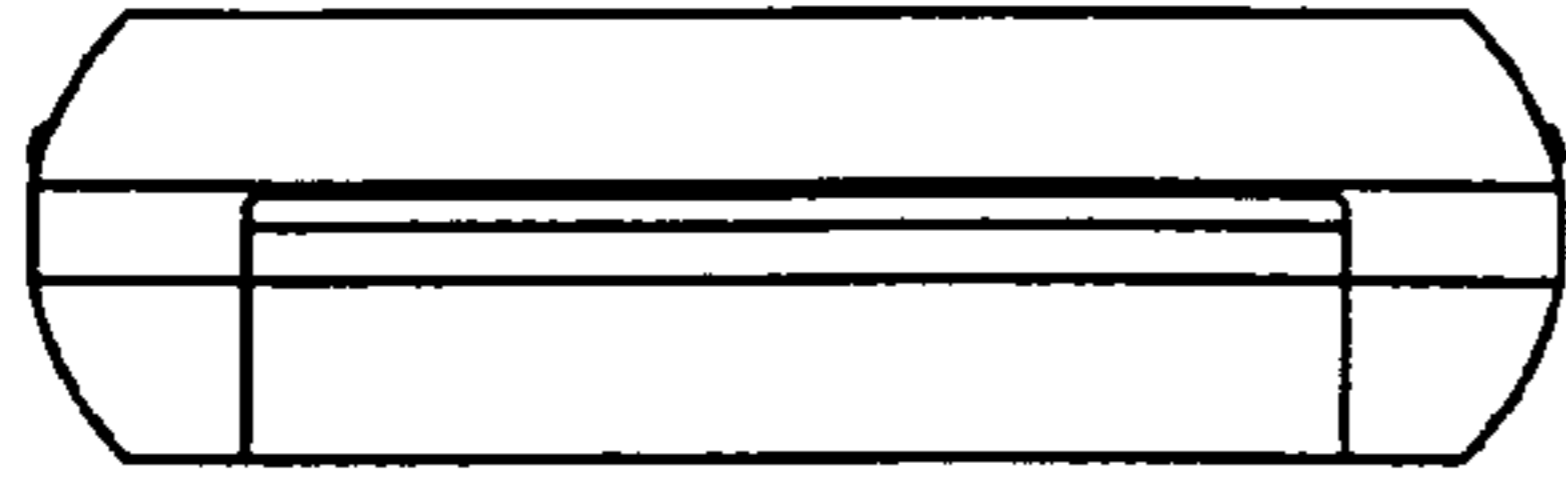

FIG. 7

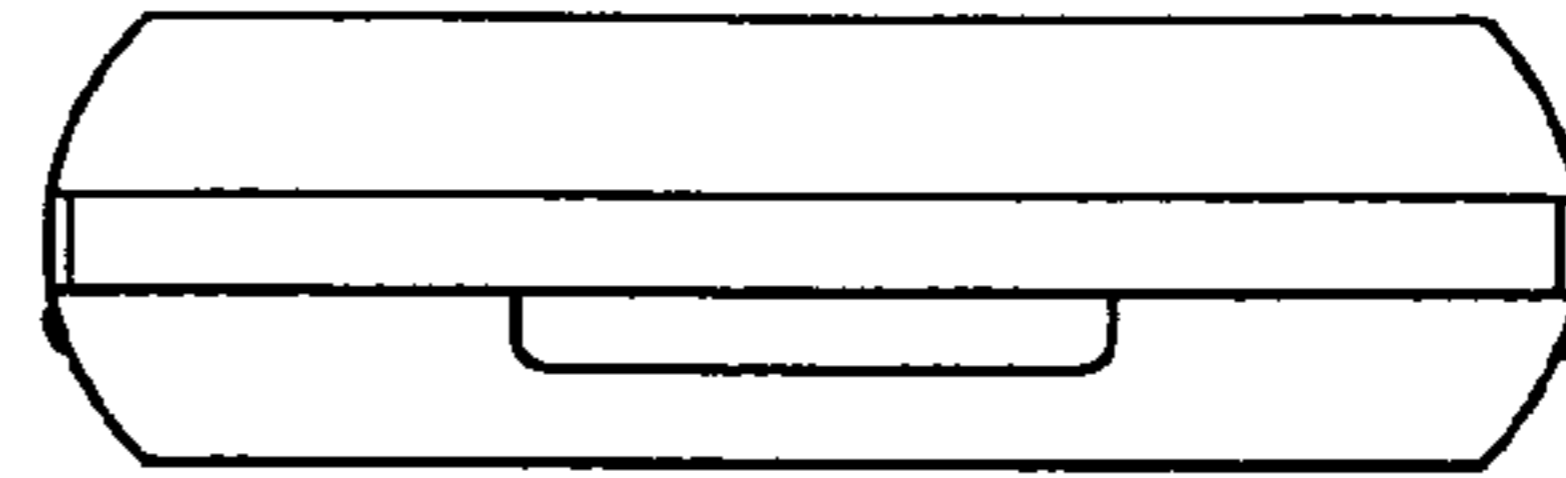

FIG. 8

