



US00D559821S

(12) **United States Design Patent** (10) **Patent No.:** **US D559,821 S**
Lee (45) **Date of Patent:** **** Jan. 15, 2008**

(54) **MOBILE PHONE**

(75) Inventor: **Young Keun Lee**, Seoul (KR)
(73) Assignee: **Samsung Electronics Co., Ltd.** (KR)
(**) Term: **14 Years**
(21) Appl. No.: **29/259,492**
(22) Filed: **May 9, 2006**

(51) **LOC (8) Cl.** **14-03**
(52) **U.S. Cl.** **D14/138**
(58) **Field of Classification Search** D14/496,
D14/138, 341-347; 455/575.3, 575.1; D21/517,
D21/329, 333

See application file for complete search history.

(56) **References Cited**

U.S. PATENT DOCUMENTS

D477,296	S	*	7/2003	Minamide	D14/138
D496,020	S	*	9/2004	Lee	D14/138
D496,347	S	*	9/2004	Choi et al.	D14/191
D499,390	S	*	12/2004	Cho	D14/138
D501,838	S	*	2/2005	Kim et al.	D14/138
D507,255	S	*	7/2005	Watanabe et al.	D14/138
D511,509	S	*	11/2005	Kim et al.	D14/138
D512,395	S	*	12/2005	Kim et al.	D14/138
D518,807	S	*	4/2006	Choi et al.	D14/138
D519,972	S	*	5/2006	Chung et al.	D14/138
7,174,195	B2	*	2/2007	Nagamine	455/575.1
D540,770	S	*	4/2007	Park et al.	D14/138
D542,759	S	*	5/2007	Kim et al.	D14/138
D543,170	S	*	5/2007	Kim et al.	D14/138
D545,795	S	*	7/2007	Kim et al.	D14/138
D546,307	S	*	7/2007	Lee	D14/138
2005/0113156	A1	*	5/2005	Park et al.	455/575.4
2005/0124392	A1	*	6/2005	Jeong	455/575.1
2006/0146030	A1	*	7/2006	Kim	345/169

OTHER PUBLICATIONS

Samsung P940 telephone, announced Dec. 2006, [online], [retrieved on Jul. 19, 2007]. Retrieved from Internet , <URL: <http://www.gsmaarena.com>>.*

Samsung P900 telephone, announced Feb. 2006, [online], [retrieved on Jul. 19, 2007]. Retrieved from Internet , <URL: <http://www.gsmaarena.com>>.*

Samsung P920 telephone, announced 2nd quarter 2006, [online], [retrieved on Jul. 19, 2007]. Retrieved from Internet , <URL: <http://www.gsmaarena.com>>.*

Samsung D830 telephone, announced Jun. 2006, [online], [retrieved on Jul. 19, 2007]. Retrieved from Internet , <URL: <http://www.gsmaarena.com>>.*

* cited by examiner

Primary Examiner—Jeffrey Asch
(74) *Attorney, Agent, or Firm*—Irving Keschner

(57) **CLAIM**

The ornamental design for mobile phone, as shown.

DESCRIPTION

FIG. 1 is a perspective view of the ornamental design of the present invention;

FIG. 2 is a front elevational view of the ornamental design of the present invention;

FIG. 3 is a rear elevational view of the ornamental design of the present invention;

FIG. 4 is a left side elevational view of the ornamental design of the present invention;

FIG. 5 is a right side elevational view of the ornamental design of the present invention;

FIG. 6 is a top plan view of the ornamental design of the present invention;

FIG. 7 is a bottom view of the ornamental design of the present invention;

FIG. 8 is a perspective view of the mobile phone in the open position; and,

FIG. 9 is a perspective view illustrating the mobile phone in the open position with the folder turned in the horizontal direction.

1 Claim, 7 Drawing Sheets

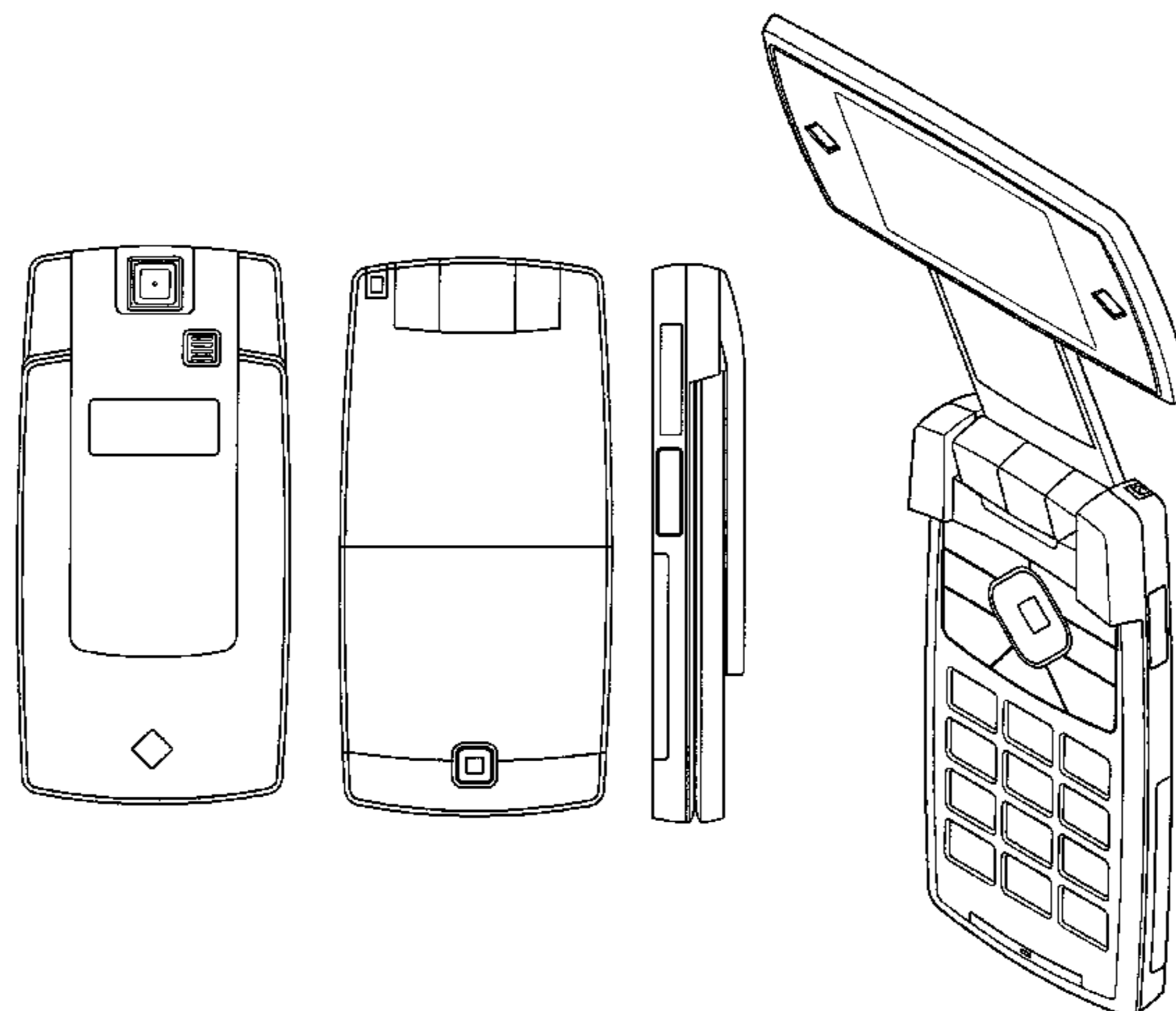

Fig. 1

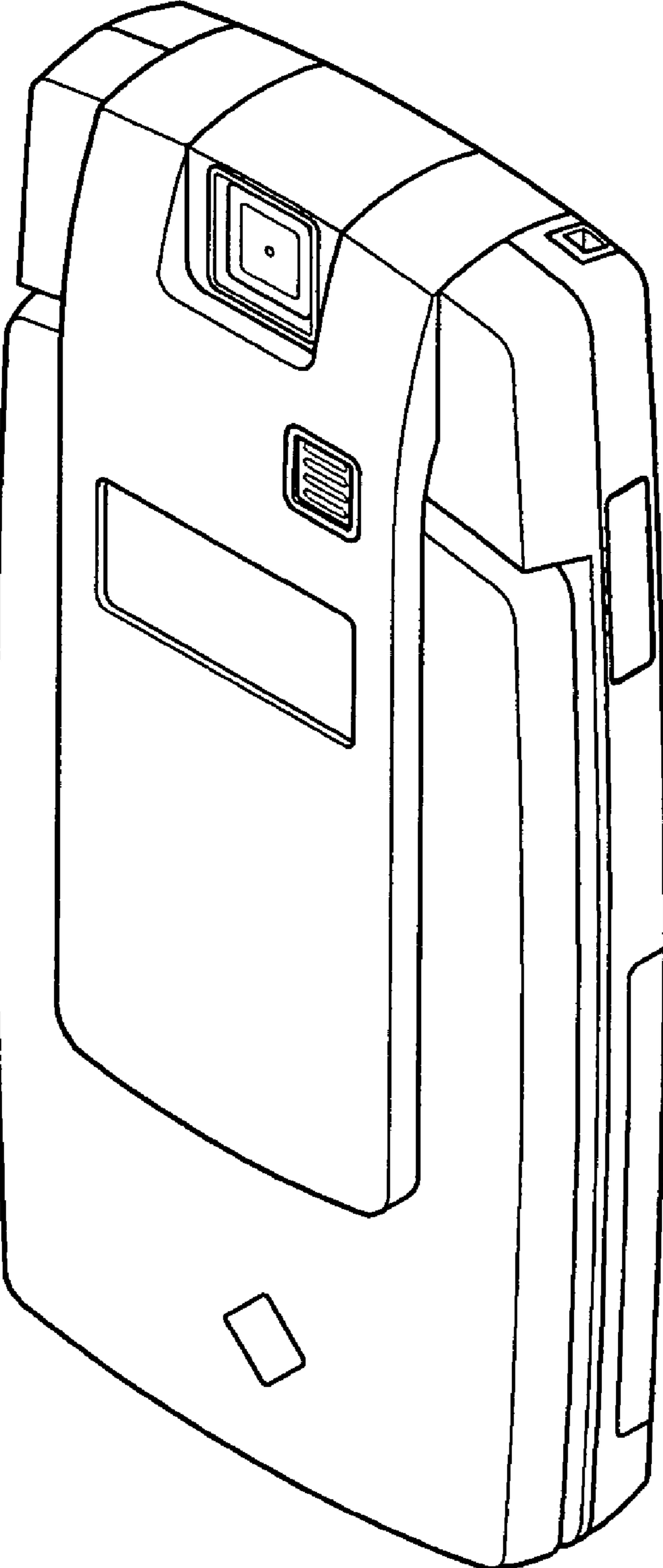

Fig. 2

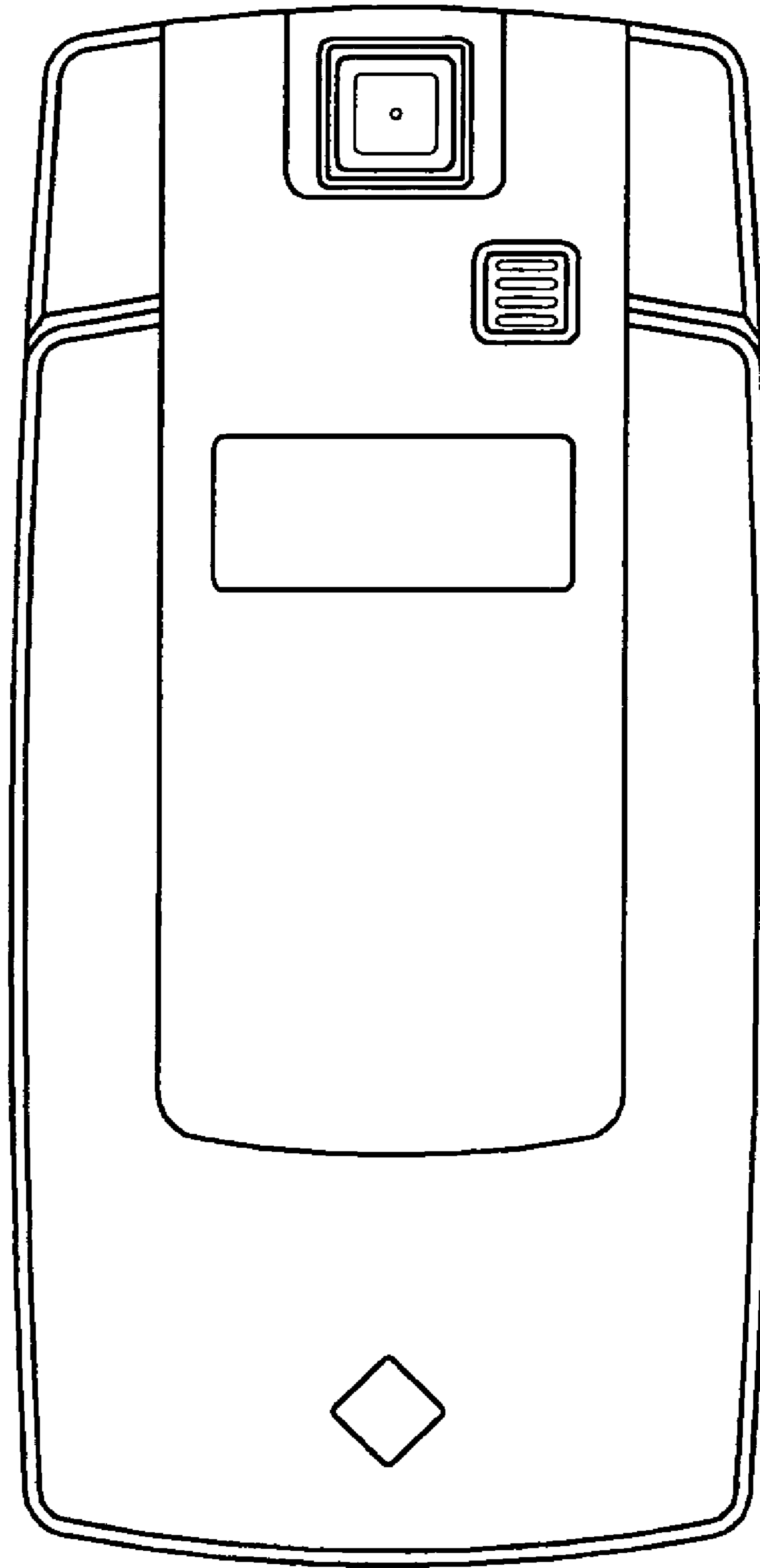

Fig. 3

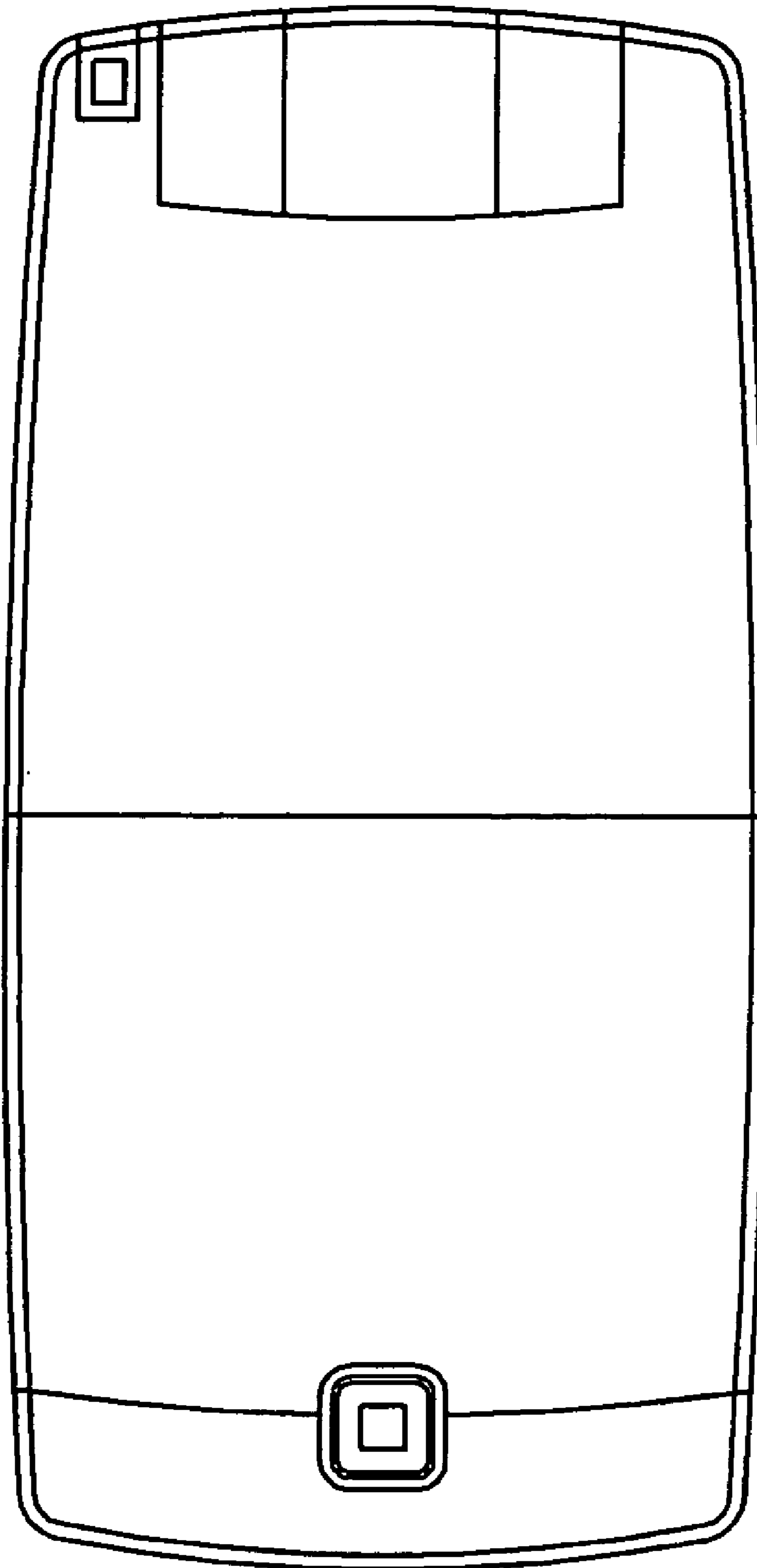

Fig. 4

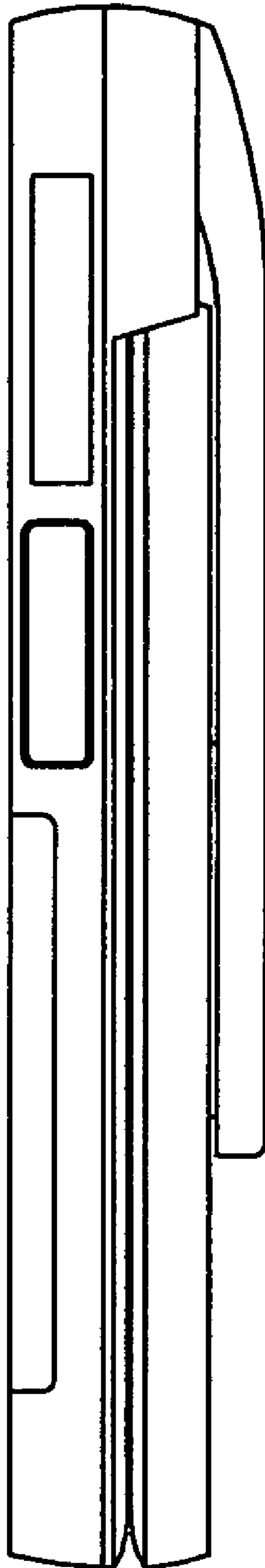

Fig. 5

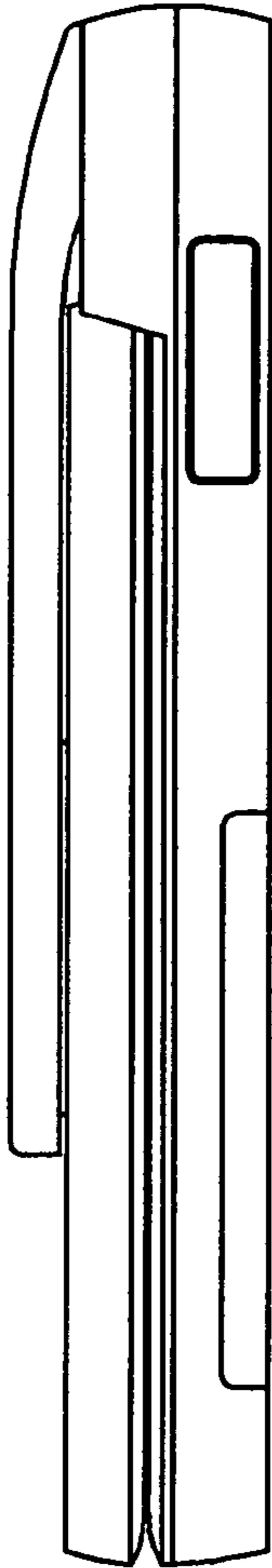

Fig. 6

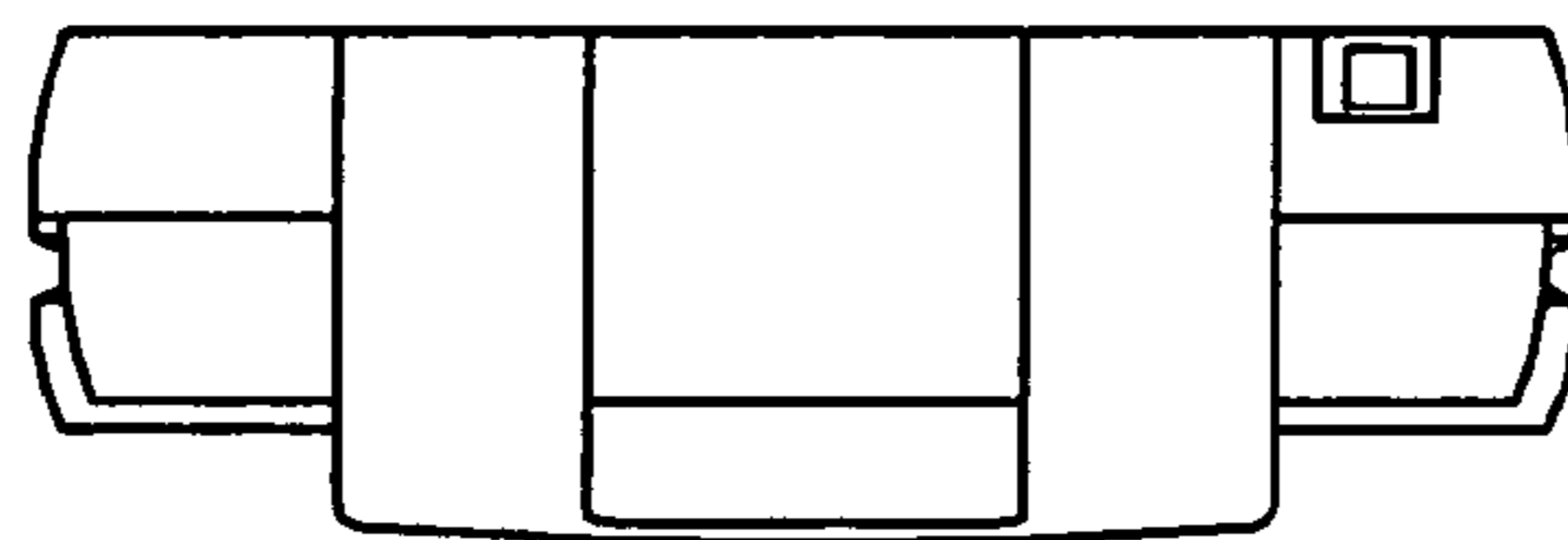

Fig. 7

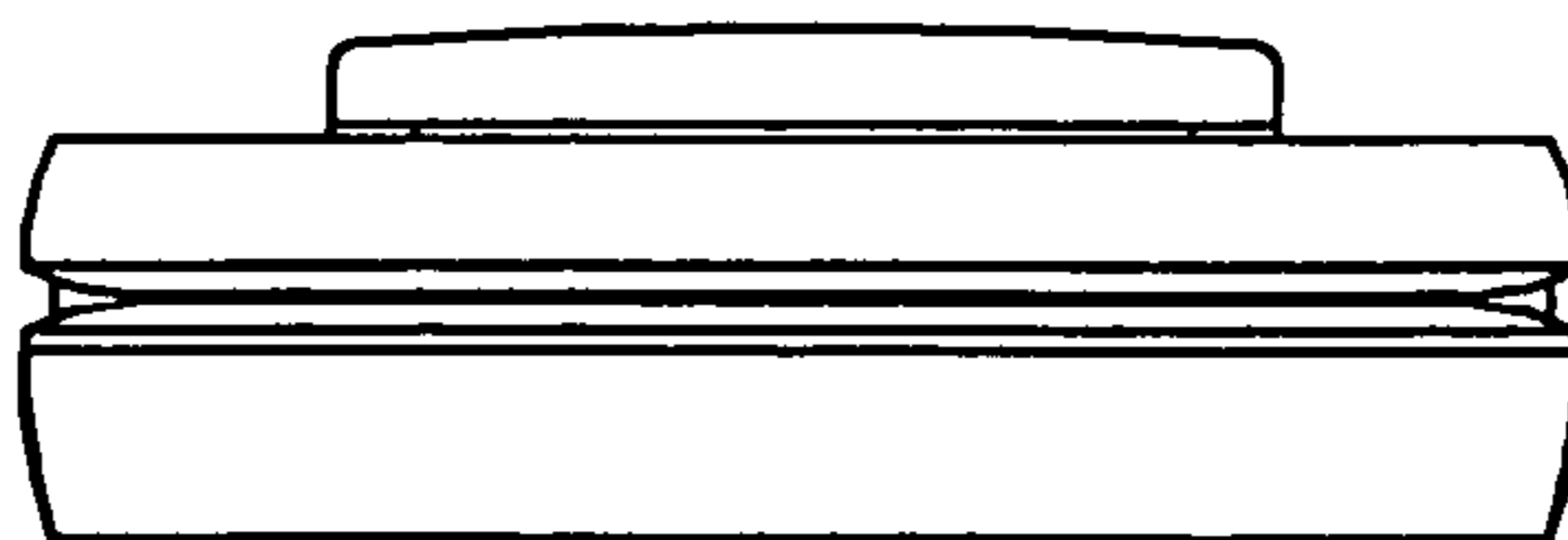

Fig. 8

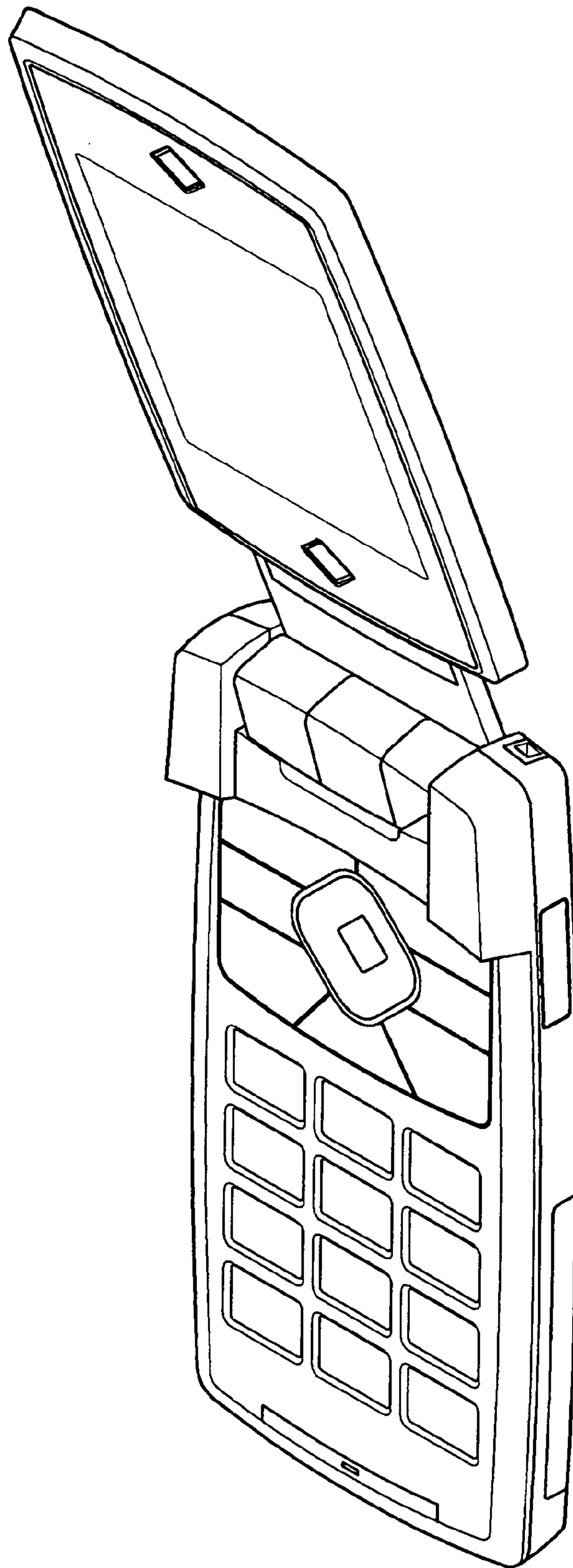

Fig. 9

