



US00D559718S

(12) **United States Design Patent**  
**Schaeken**

(10) **Patent No.:** **US D559,718 S**

(45) **Date of Patent:** **\*\* Jan. 15, 2008**

(54) **BURGLAR ALARM**

(75) Inventor: **Dave Schaeken**, Eindhoven (NL)

(73) Assignee: **Securitas Direct AB**, Linköping (SE)

(\*\*) Term: **14 Years**

(21) Appl. No.: **29/258,008**

(22) Filed: **Apr. 14, 2006**

(30) **Foreign Application Priority Data**

Oct. 17, 2005 (EM) ..... 000422308

(51) **LOC (8) Cl.** ..... **10-05**

(52) **U.S. Cl.** ..... **D10/104**

(58) **Field of Classification Search** ..... D10/104,  
D10/106; D14/140; D13/162.1, 168; D8/330;  
340/539.31, 693.6, 541  
See application file for complete search history.

(56) **References Cited**

**U.S. PATENT DOCUMENTS**

D282,463 S *	2/1986	Barr et al. ....	D14/140
D346,755 S *	5/1994	Soloway ....	D10/106
D383,689 S *	9/1997	Issa ....	D10/104
D389,762 S *	1/1998	Yorkey ....	D10/104
5,805,064 A *	9/1998	Yorkey ....	340/550
D406,567 S *	3/1999	Roman ....	D13/162.1
D424,466 S *	5/2000	Morrow et al. ....	D10/106
D447,075 S *	8/2001	Roberts ....	D10/106
D493,148 S *	7/2004	Shibata et al. ....	D13/168
D495,578 S *	9/2004	Sampson et al. ....	D8/330
D496,634 S *	9/2004	Tseng et al. ....	D13/168
D505,393 S *	5/2005	Mullet et al. ....	D13/168
D515,955 S *	2/2006	Edwards ....	D10/104
D525,160 S *	7/2006	Kurata ....	D10/104
D528,511 S *	9/2006	Li ....	D13/168
D528,512 S *	9/2006	Li ....	D13/168

2006/0033635 A1\* 2/2006 Chen ..... 340/693.6

**FOREIGN PATENT DOCUMENTS**

EM 000442124-0001 1/2006

\* cited by examiner

*Primary Examiner*—Robert M. Spear

*Assistant Examiner*—George D Kirschbaum

(74) *Attorney, Agent, or Firm*—Birch, Stewart, Kolasch & Birch, LLP

(57) **CLAIM**

The ornamental design for a burglar alarm, as shown and described.

**DESCRIPTION**

FIG. 1 is a front, left perspective view of a burglar alarm showing my new design;

FIG. 2 is a right side view thereof;

FIG. 3 is a left side view thereof;

FIG. 4 is a top plan view thereof;

FIG. 5 is a bottom plan view thereof;

FIG. 6 is a front elevational view thereof; and

FIG. 7 is a rear elevational view thereof;

FIG. 8 is a front, left perspective view of a burglar alarm in an open state, showing my new design;

FIG. 9 is a right side view thereof;

FIG. 10 is a left side view thereof;

FIG. 11 is a top plan view thereof;

FIG. 12 is a bottom plan view thereof;

FIG. 13 is a front elevational view thereof; and,

FIG. 14 is a rear elevational view thereof.

**1 Claim, 7 Drawing Sheets**

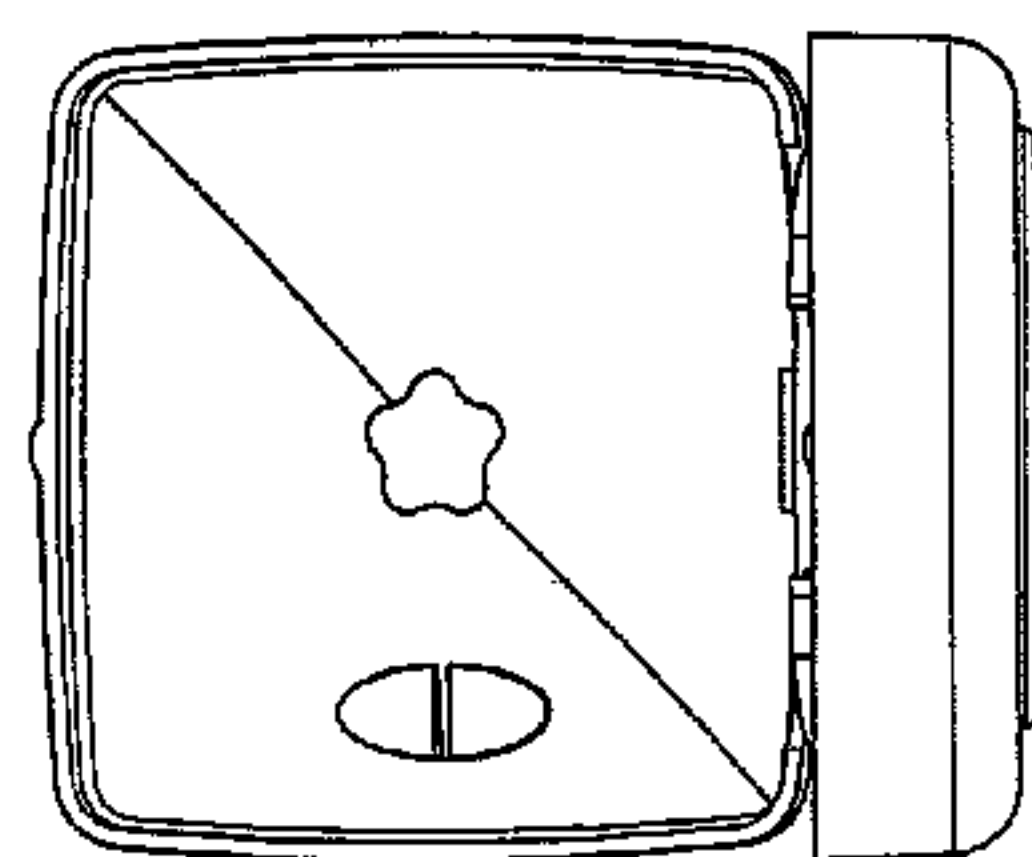
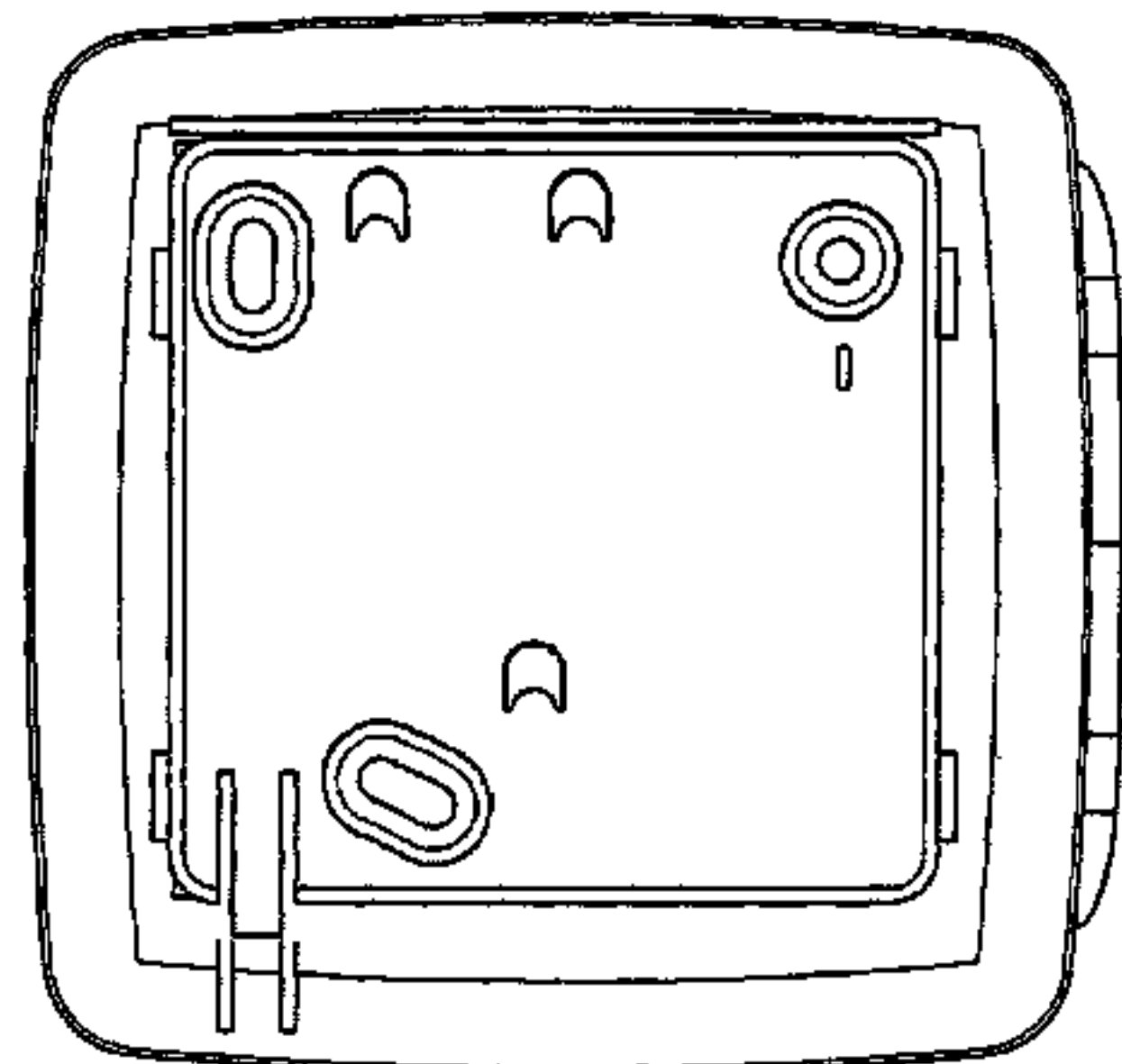
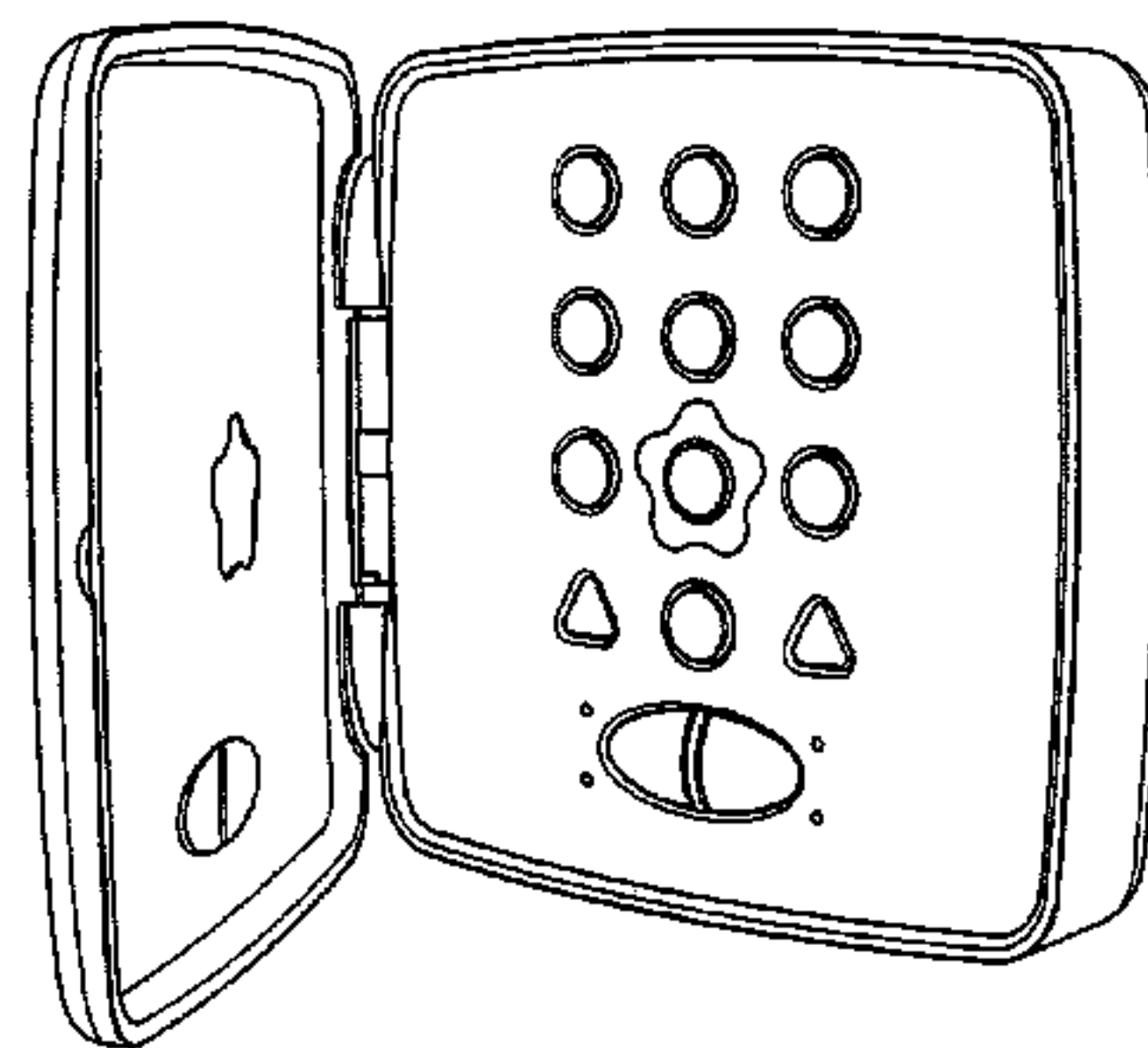
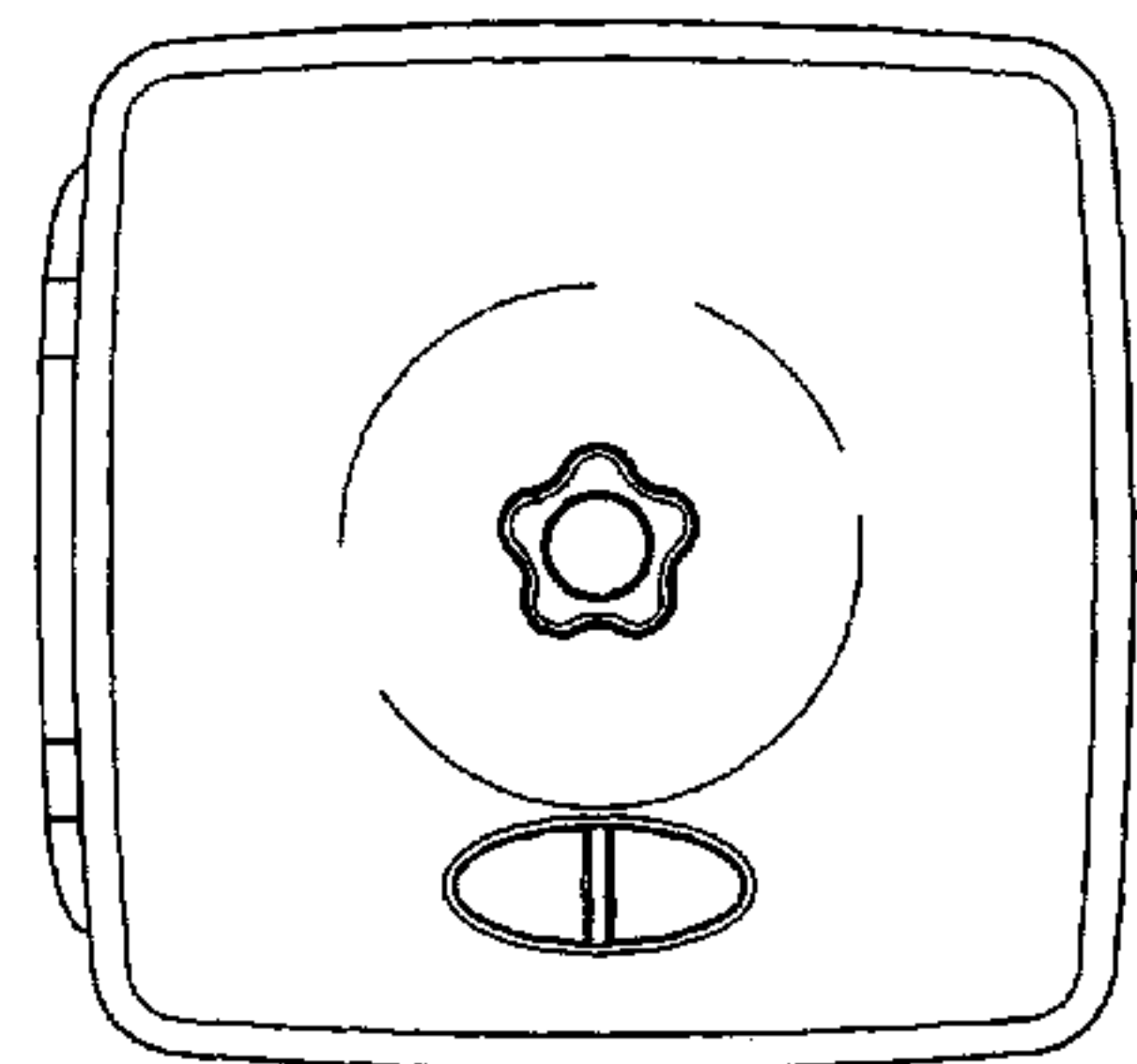

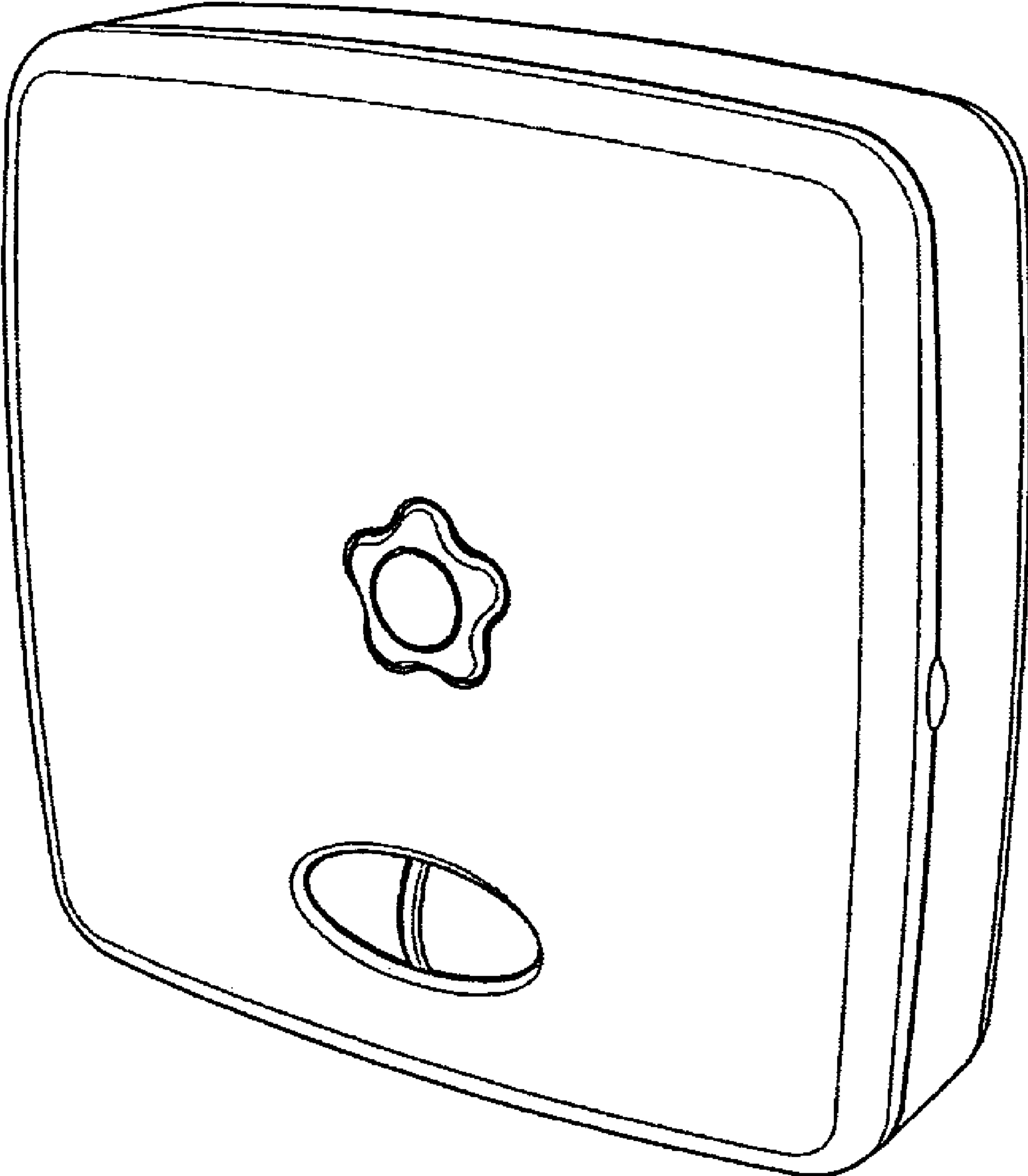

FIG. 1

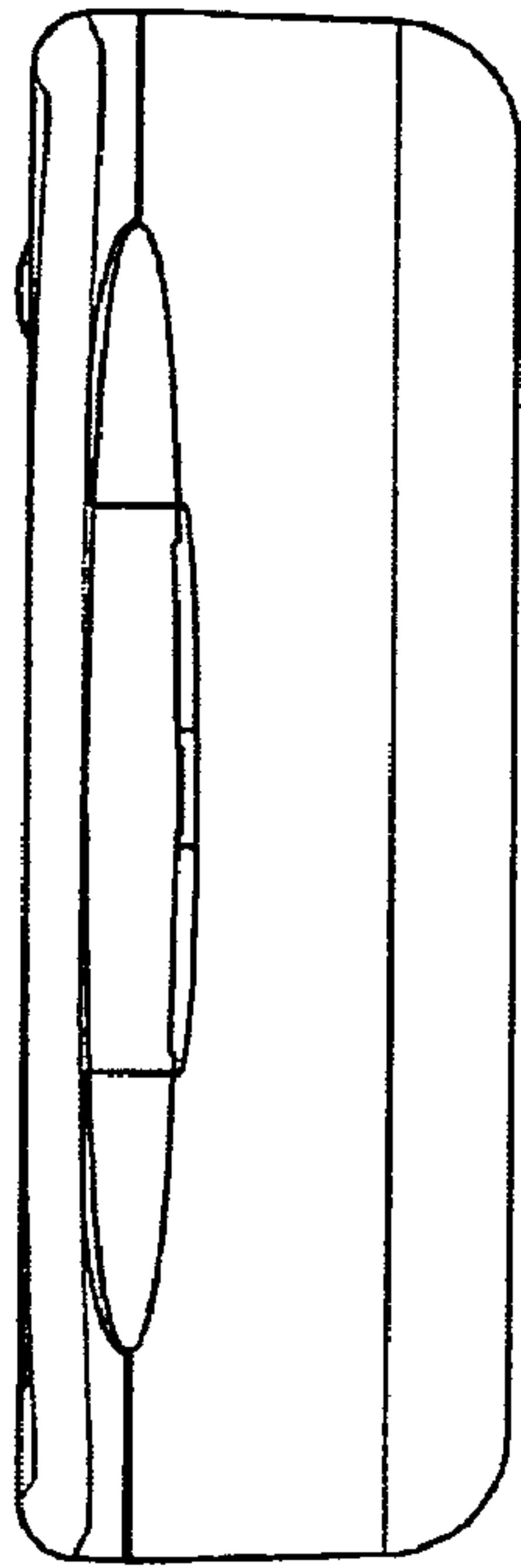

FIG. 2

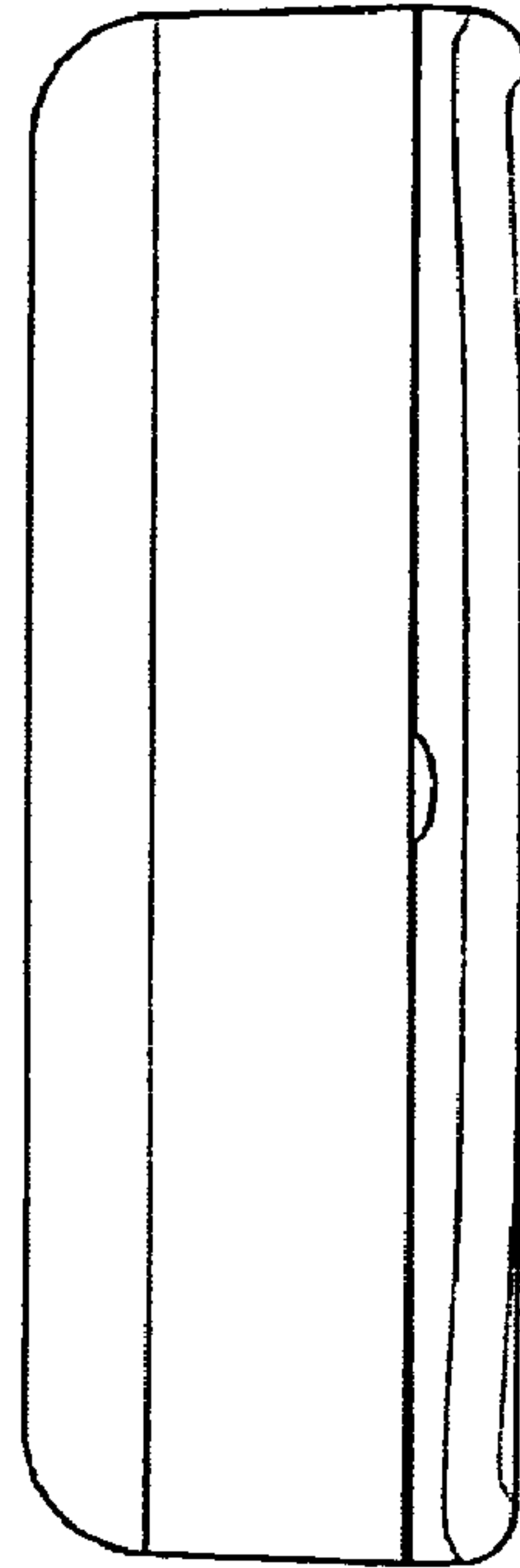

FIG. 3

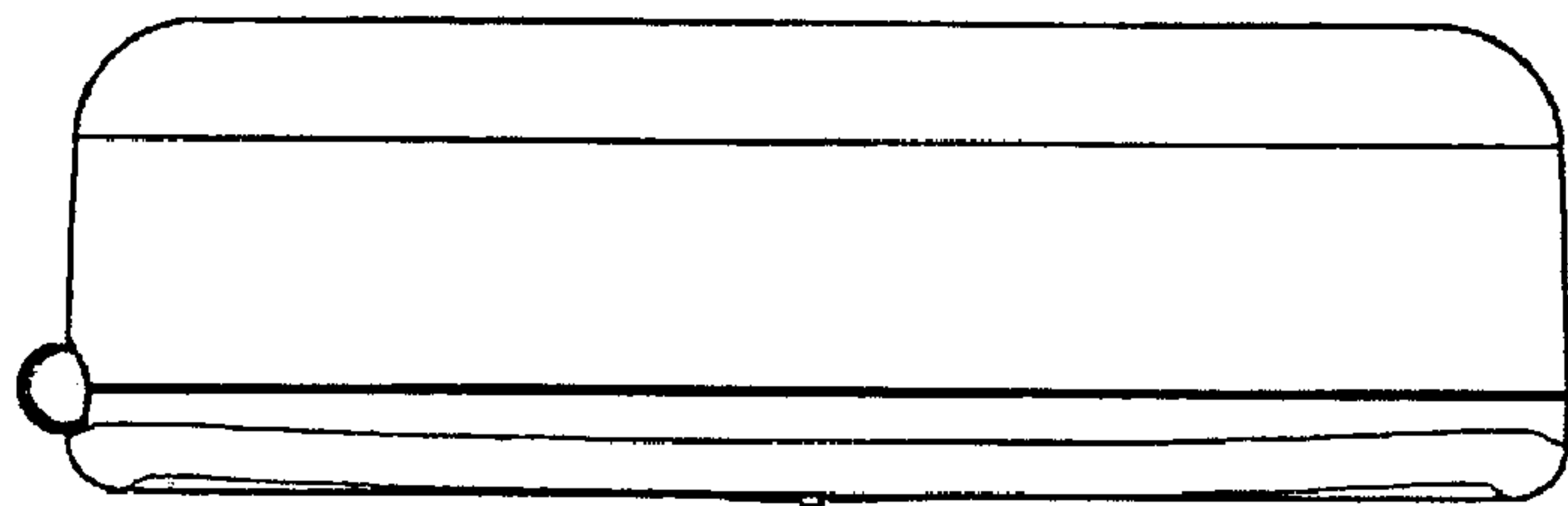

FIG. 4

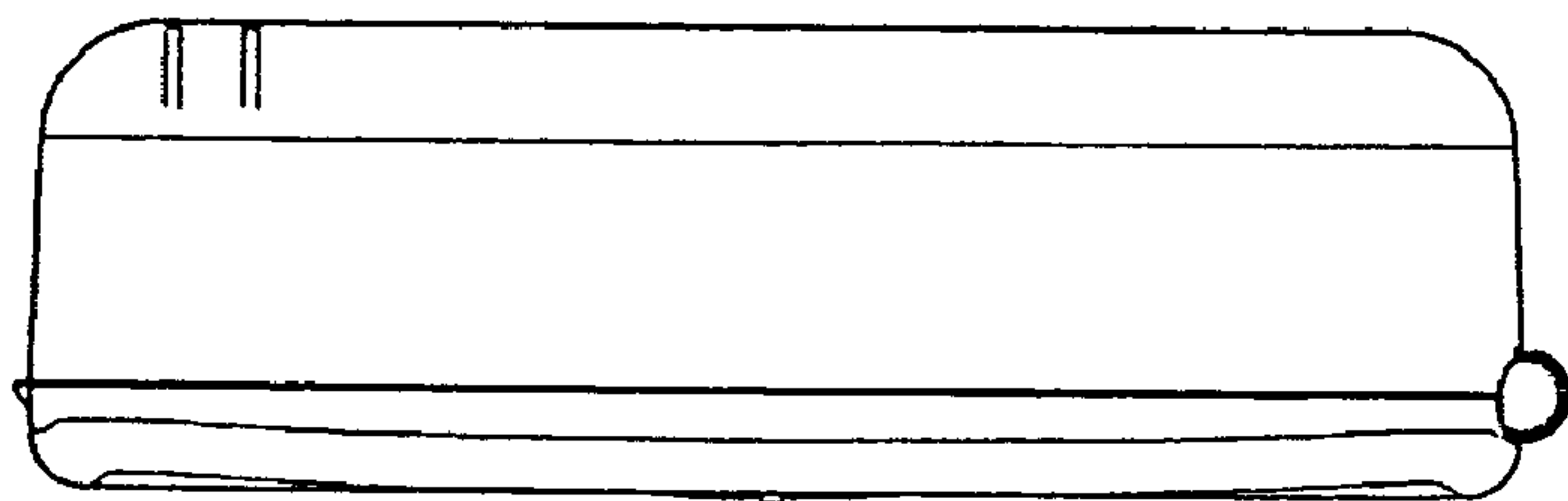

FIG. 5

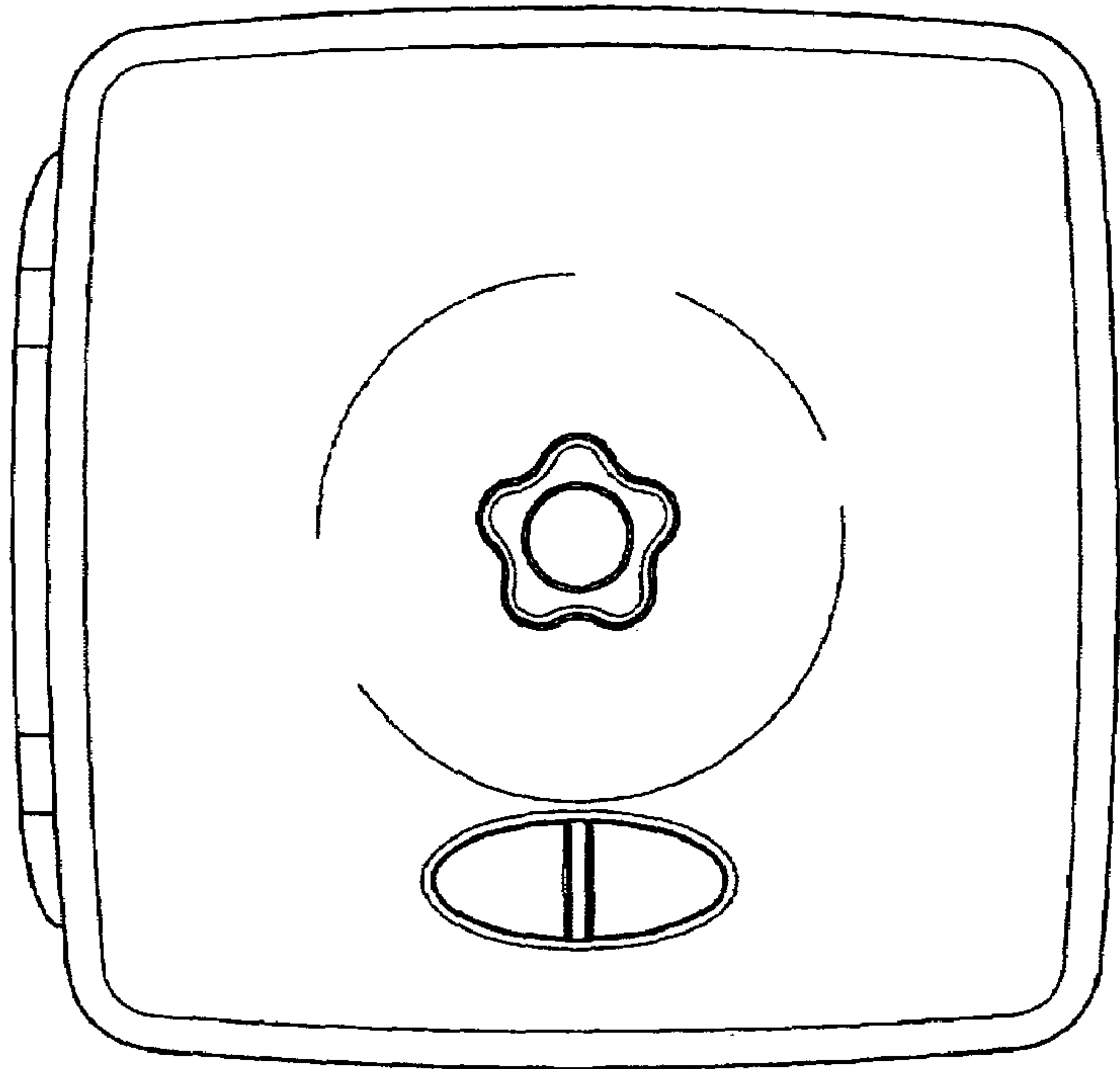

FIG. 6

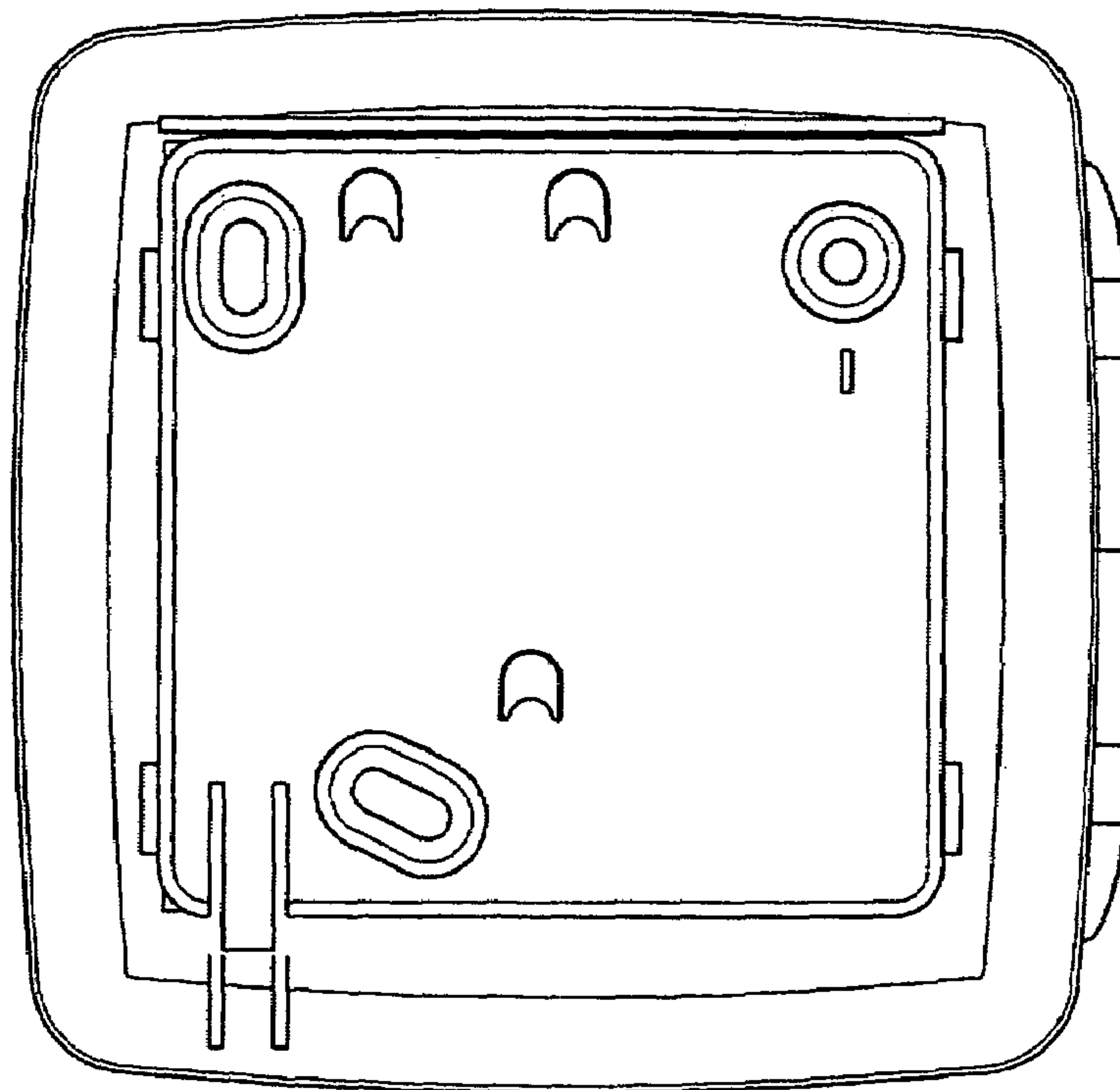

FIG. 7

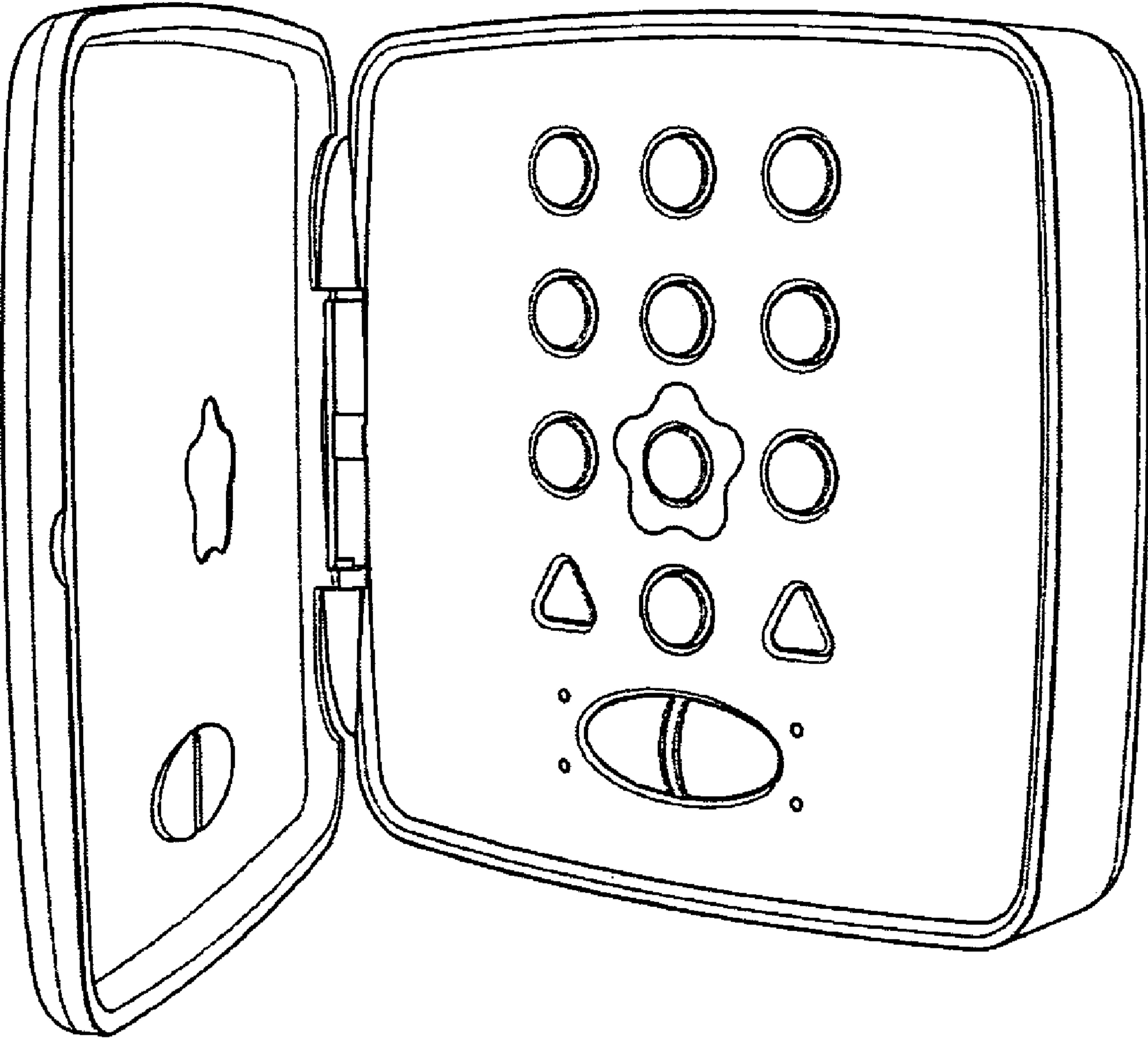

FIG. 8

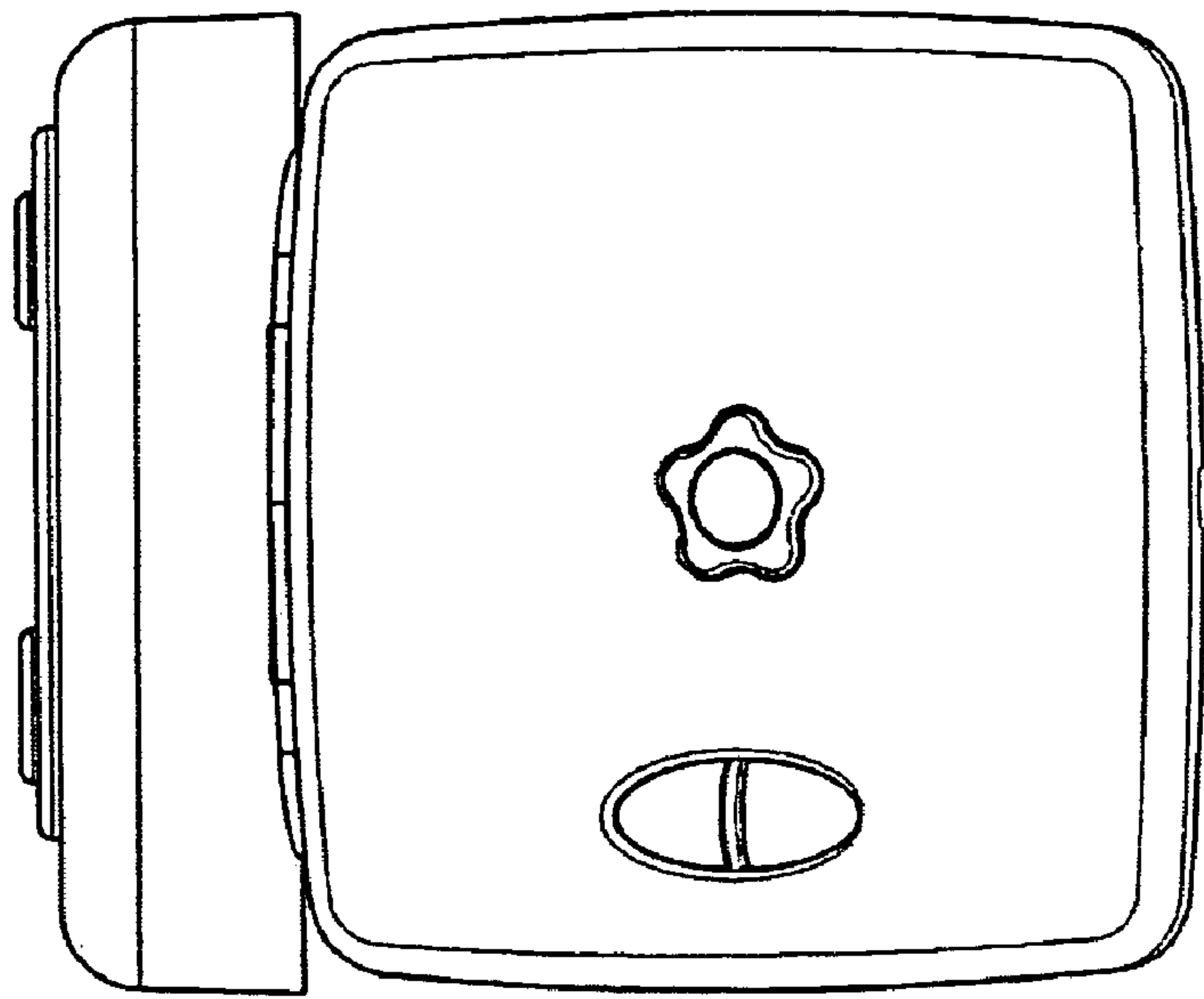

FIG. 9

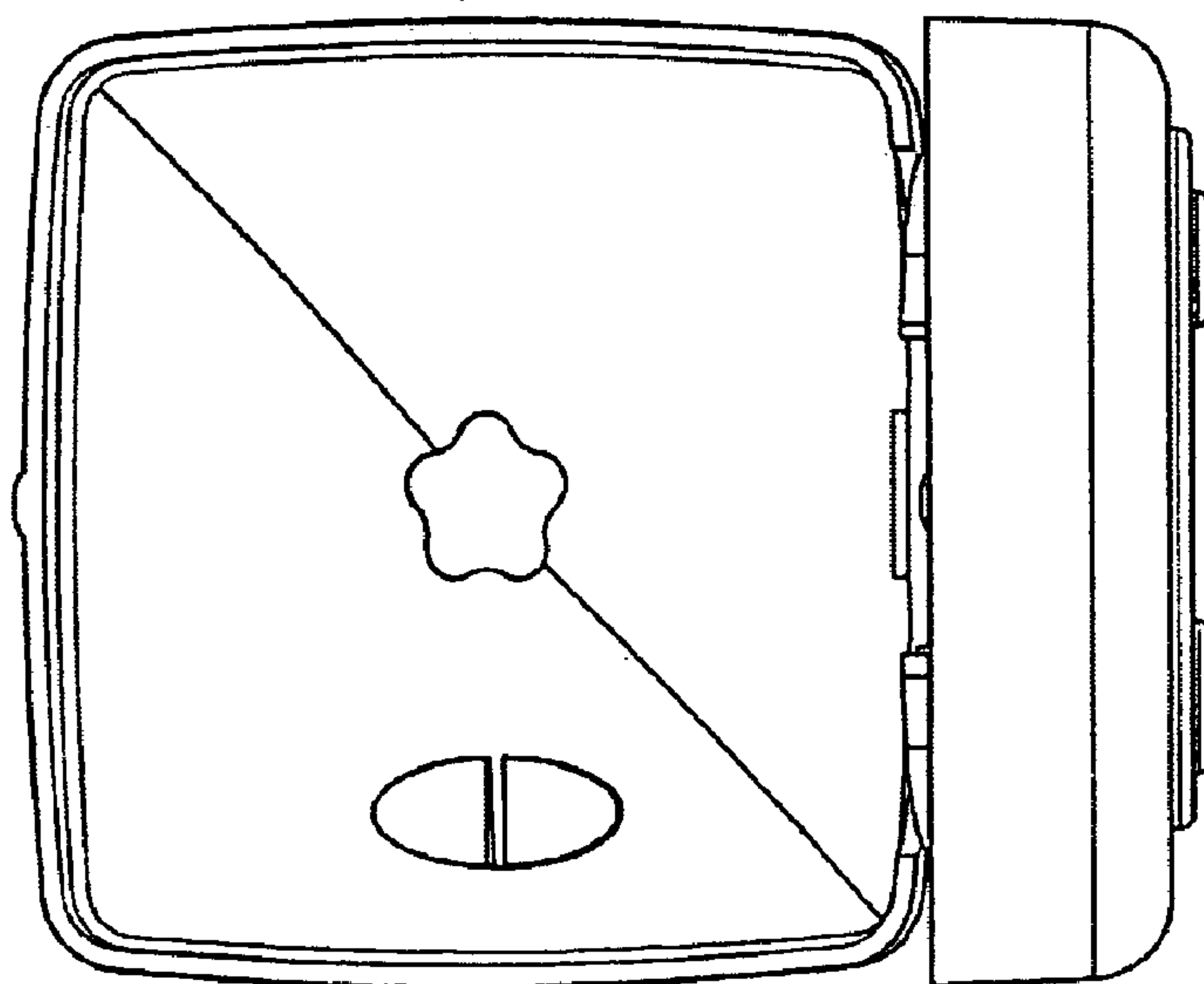

FIG. 10



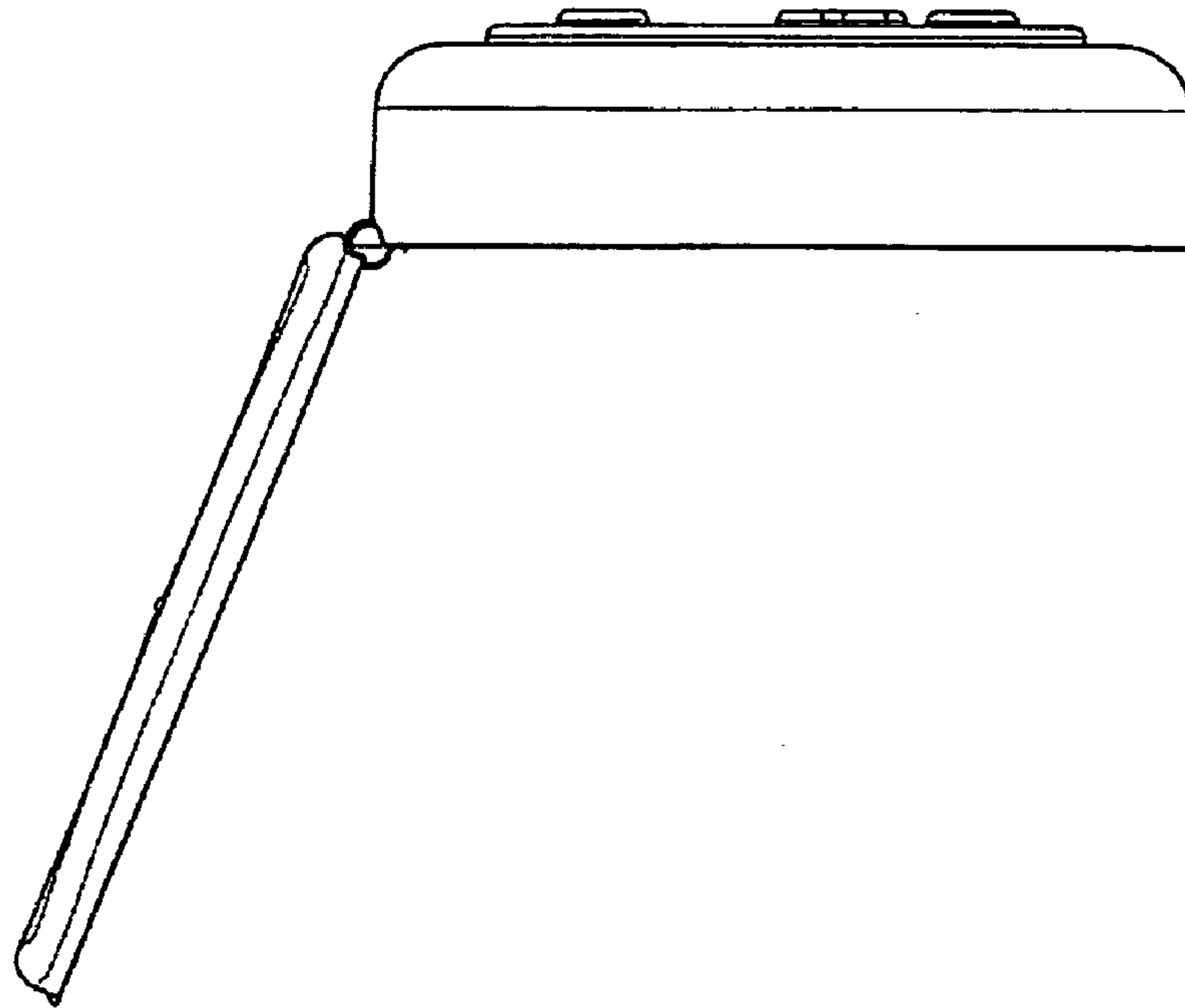

FIG. 11

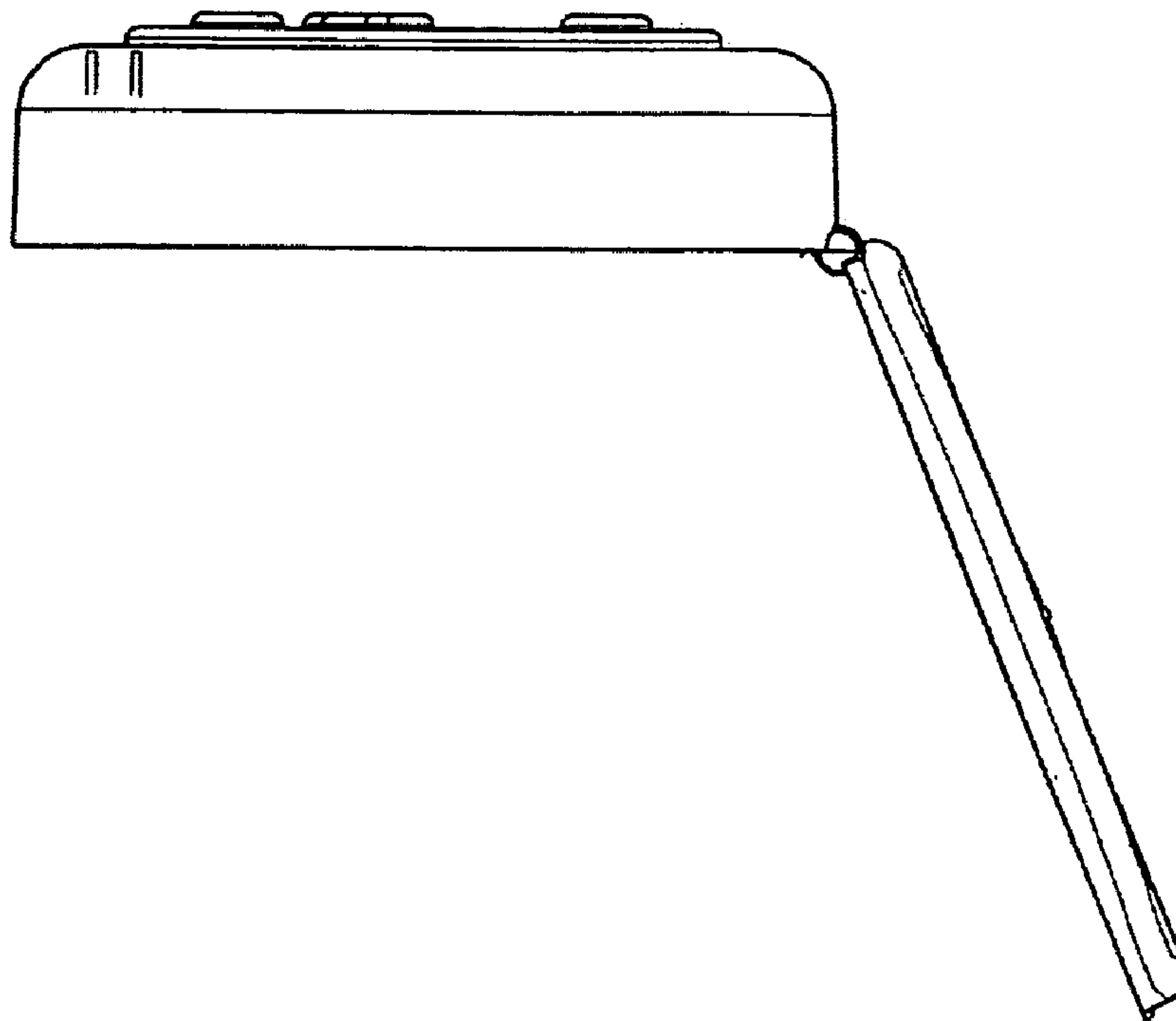

FIG. 12

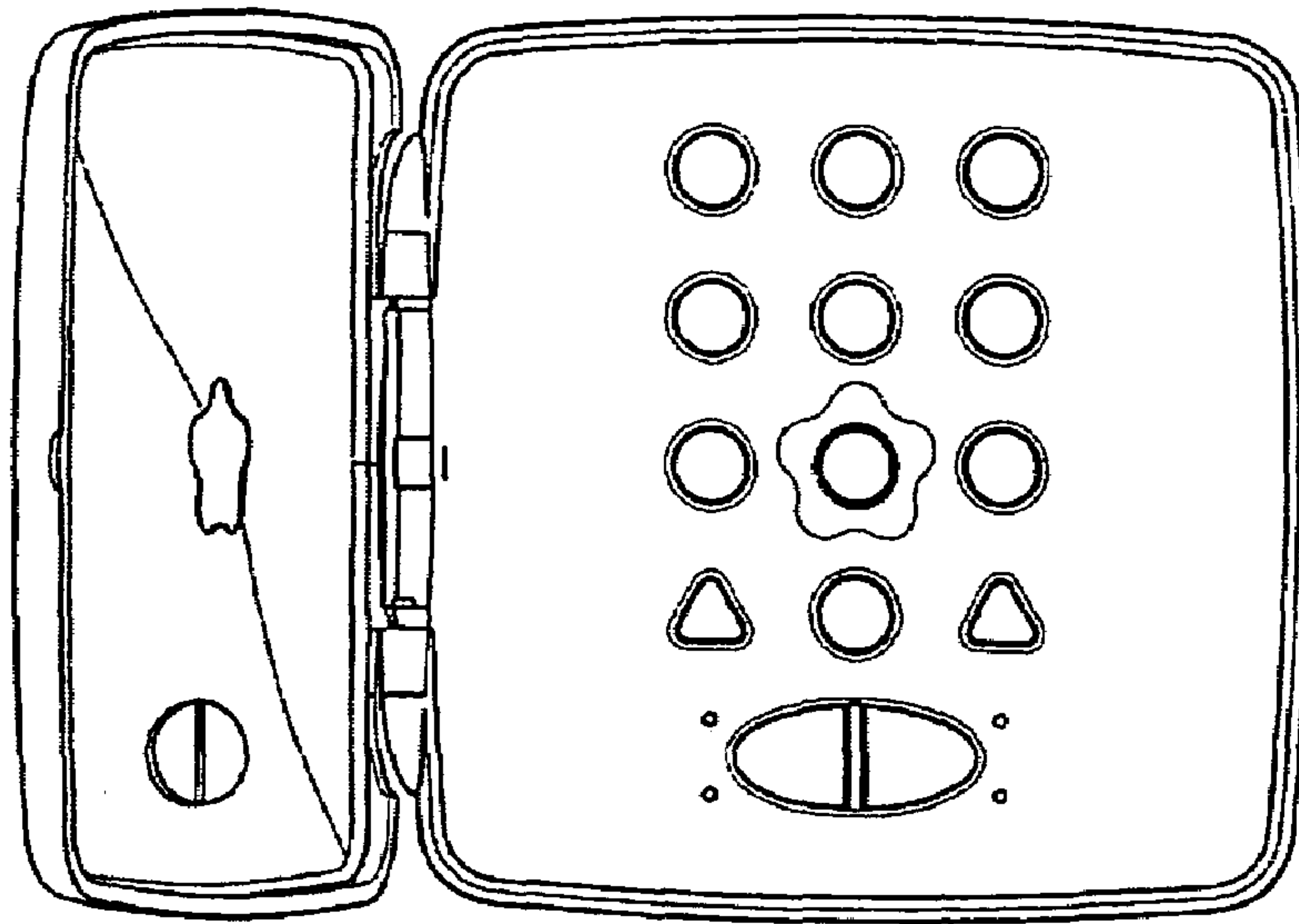

FIG. 13

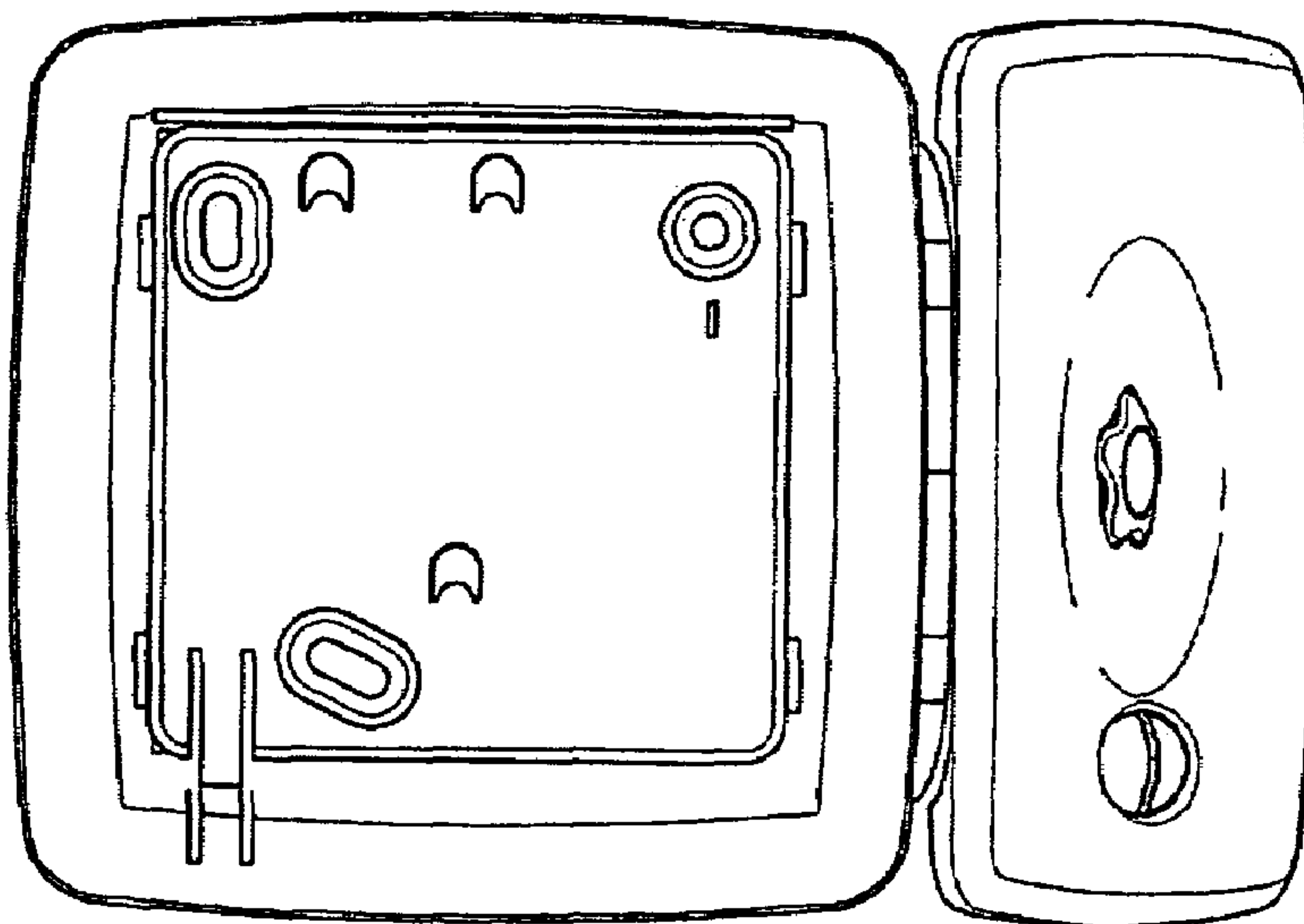

FIG. 14