



US00D559705S

(12) **United States Design Patent**
Sparks et al.

(10) **Patent No.:** **US D559,705 S**
(45) **Date of Patent:** **** Jan. 15, 2008**

(54) **STAIN TREATMENT APPLICATOR**

(75) Inventors: **Evan A. Sparks**, Madison, WI (US);
Kevin L. Askling, Madison, WI (US)

(73) Assignee: **S.C. Johnson & Son, Inc.**, Racine, WI (US)

(**) Term: **14 Years**

(21) Appl. No.: **29/250,720**

(22) Filed: **Nov. 29, 2006**

(51) **LOC (8) Cl.** **09-01**

(52) **U.S. Cl.** **D9/723**

(58) **Field of Classification Search** D9/516,
D9/522, 529, 721, 723, 724, 726, 728; D19/64,
D19/66, 70; 215/382-384, 396, 398; 220/660,
220/662, 666, 669, 675; 222/1, 630; 221/1,
221/135

See application file for complete search history.

(56) **References Cited**

U.S. PATENT DOCUMENTS

- D280,077 S * 8/1985 Lemaire D9/522
- D438,459 S * 3/2001 Holthaus D9/728
- D447,953 S * 9/2001 Brynestad et al. D9/529
- D473,141 S * 4/2003 Cummings D9/529
- D476,235 S * 6/2003 Steinhoff D9/529

- D496,279 S * 9/2004 Hama et al. D9/529
- D508,858 S * 8/2005 Sato et al. D9/724
- D527,640 S * 9/2006 Cummings et al. D9/529
- D542,141 S * 5/2007 Okin et al. D9/529

* cited by examiner

Primary Examiner—Stella M. Reid
Assistant Examiner—Shanda C. Hill

(57) **CLAIM**

The ornamental design for a “stain treatment applicator,” as shown and described.

DESCRIPTION

FIG. 1 is a perspective view of a stain treatment applicator showing our new design;

FIG. 2 is a left side elevational view thereof;

FIG. 3 is a top plan view thereof;

FIG. 4 is a front elevational view thereof;

FIG. 5 is a bottom plan view thereof;

FIG. 6 is a right side elevational view thereof; and,

FIG. 7 is a rear elevational view thereof.

The broken lines showing absorbent pads and instructional indicia appearing in FIGS. 1-7 are for the purpose of illustration only, and form no part of the claimed design.

1 Claim, 3 Drawing Sheets

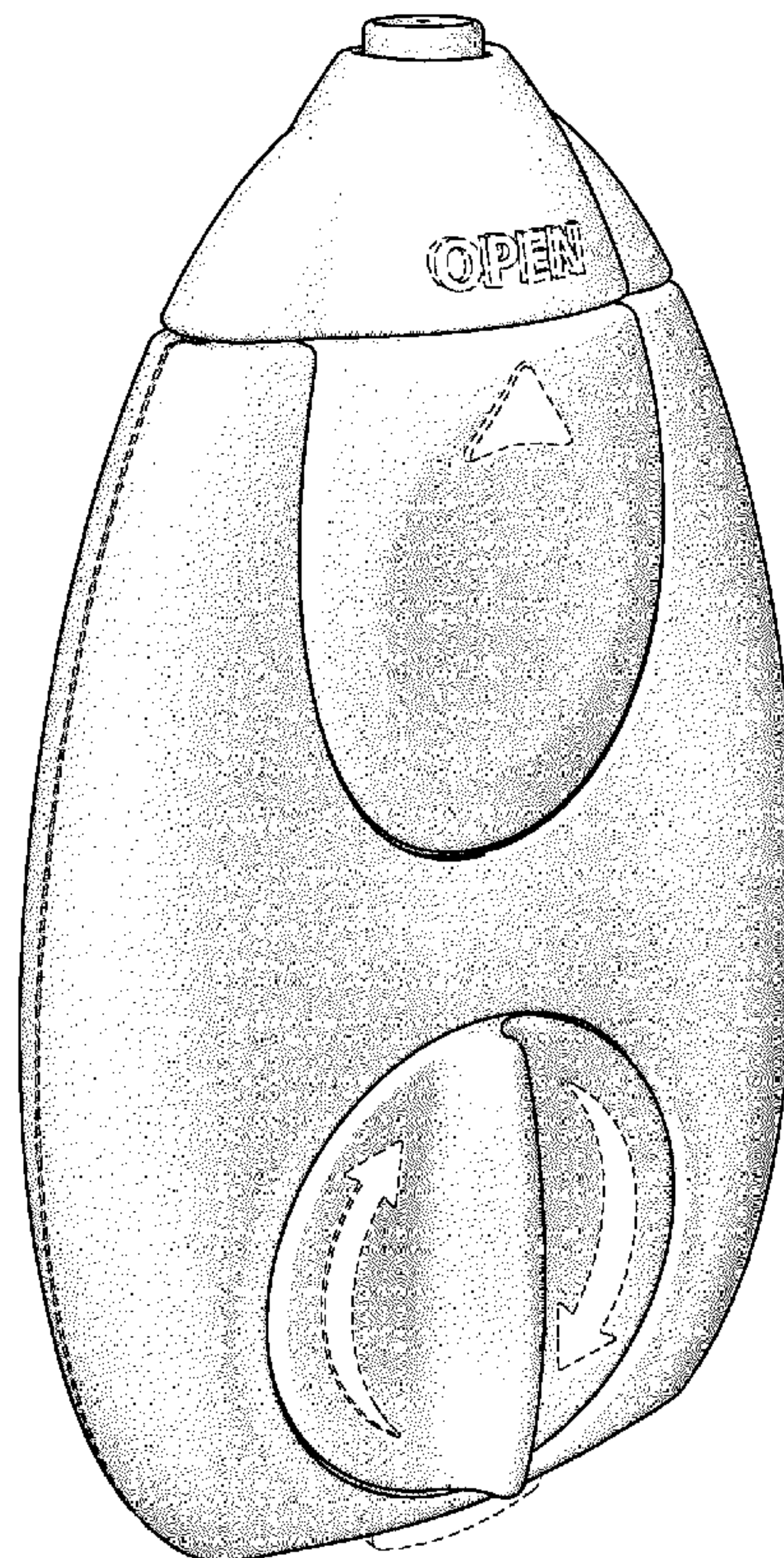

FIG. 1

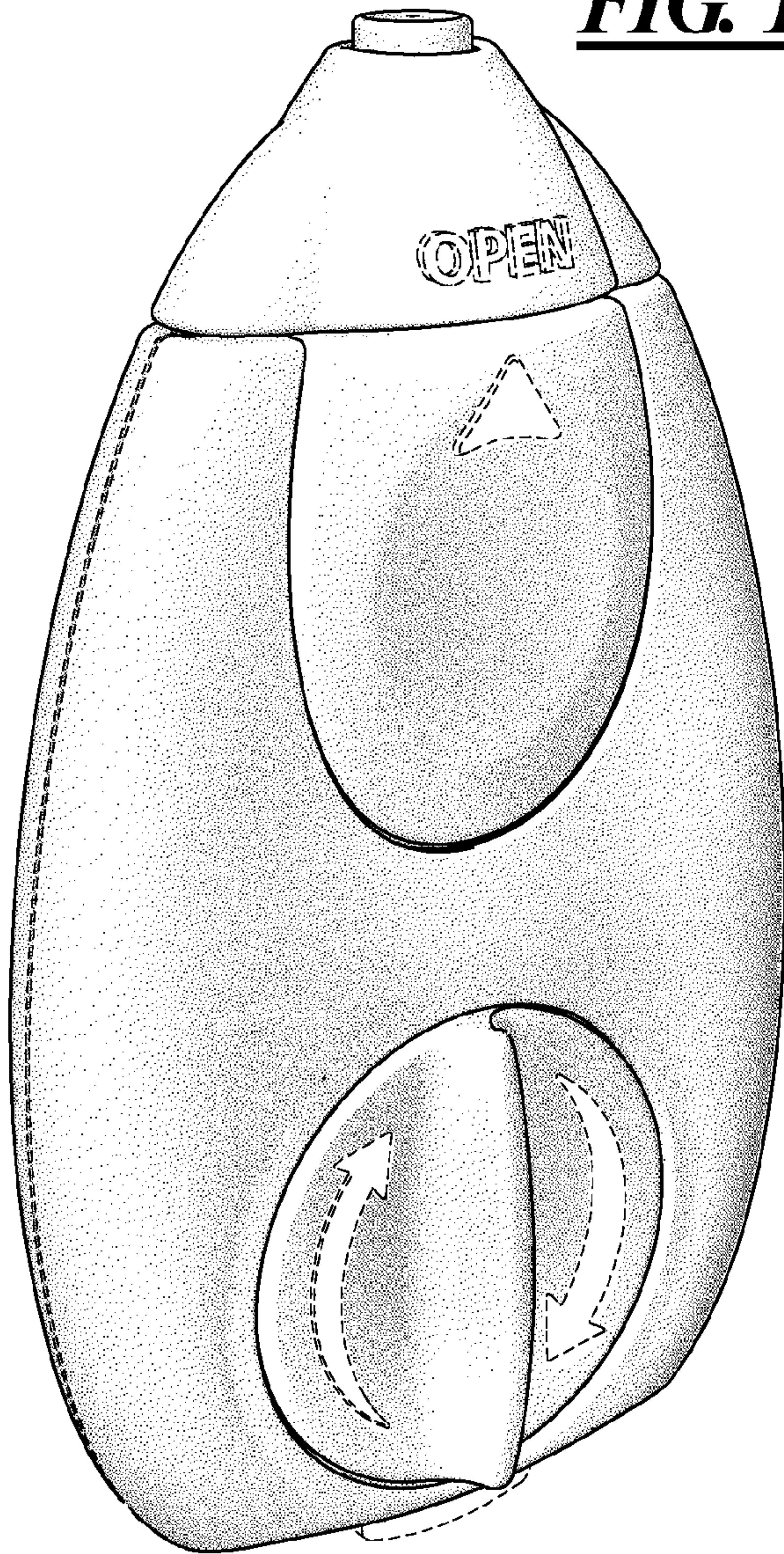

FIG. 2

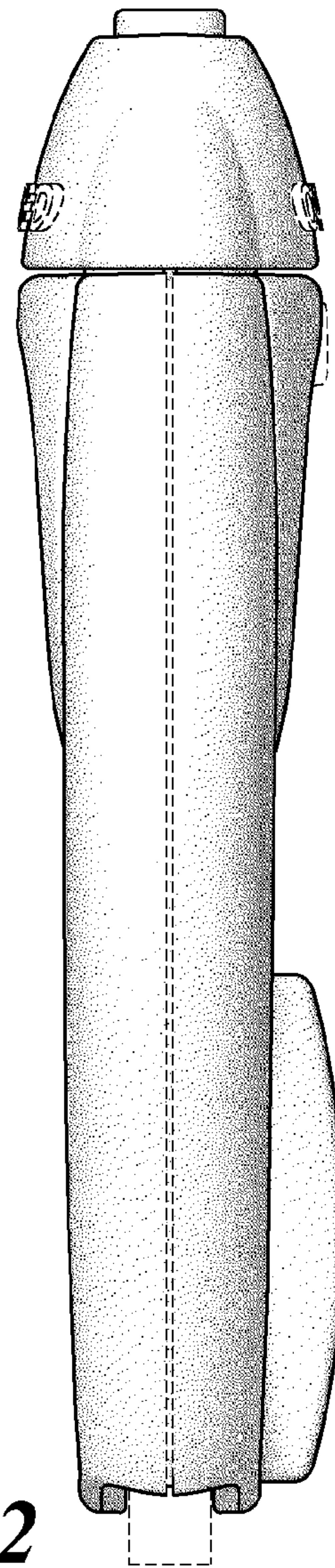
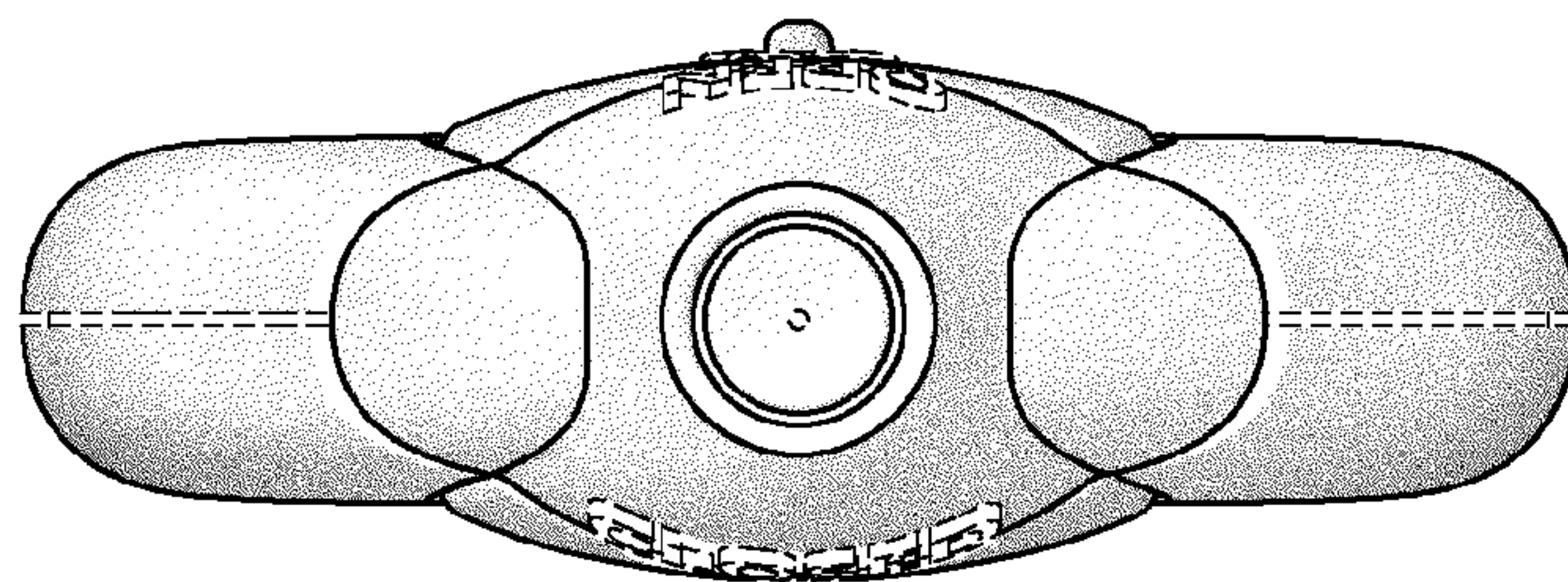
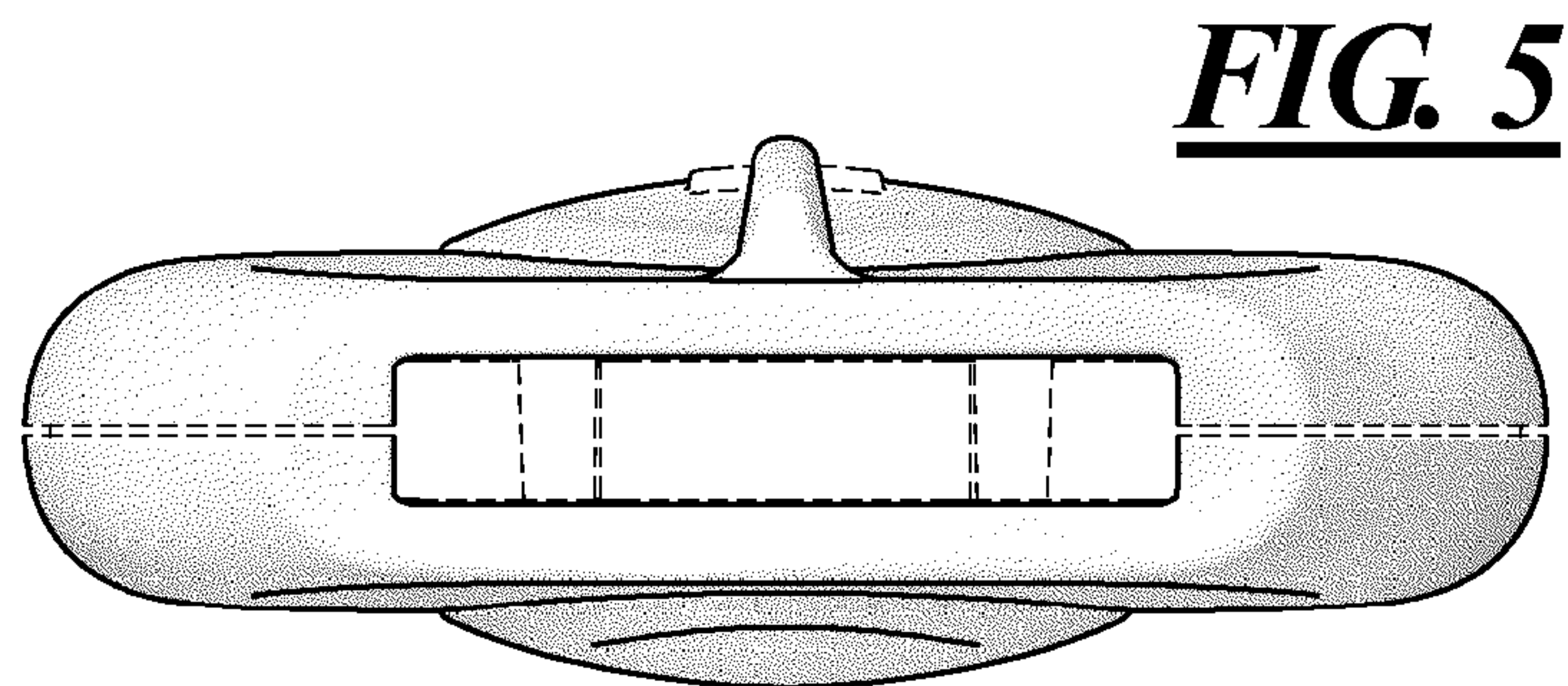
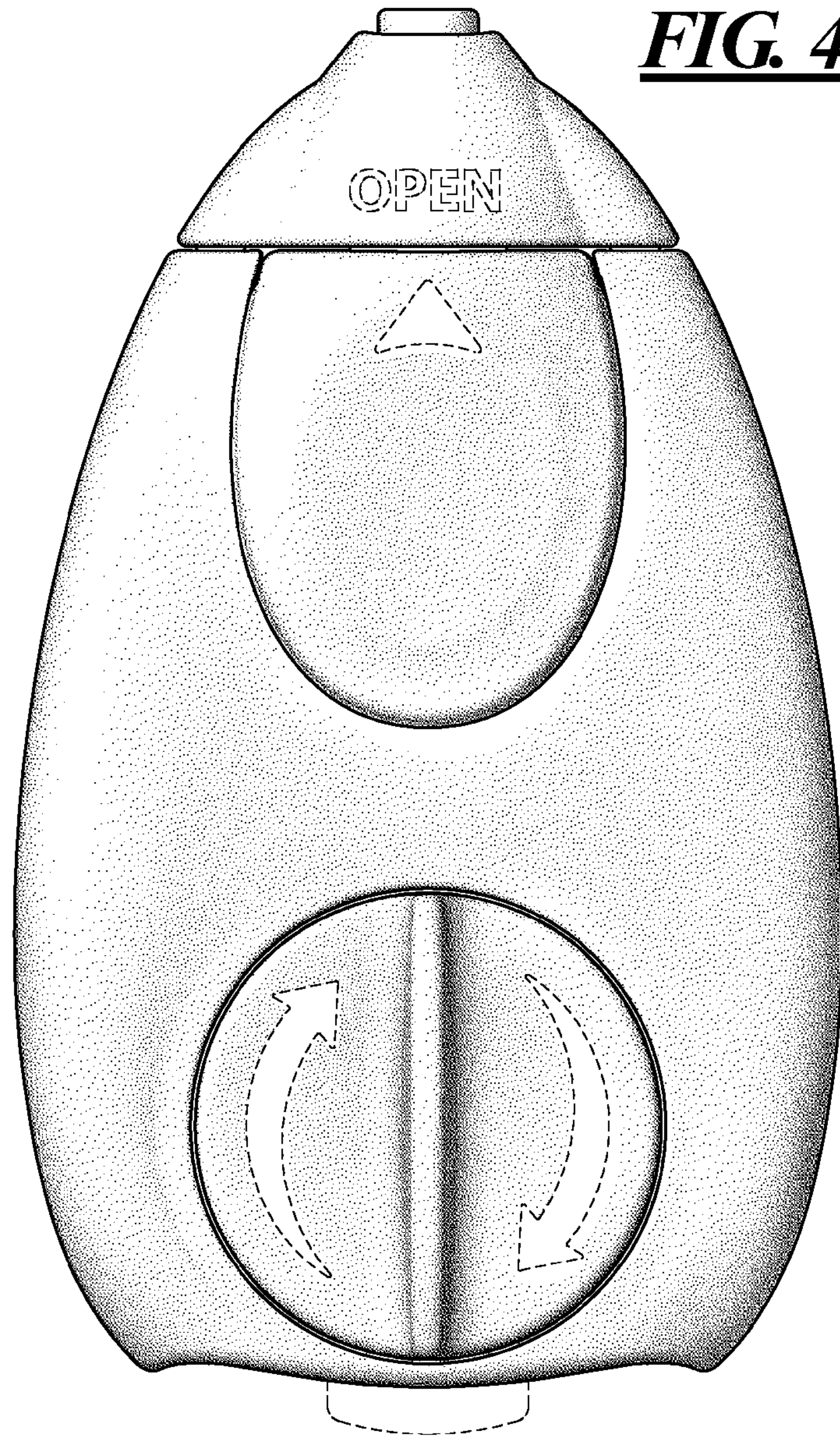

FIG. 3





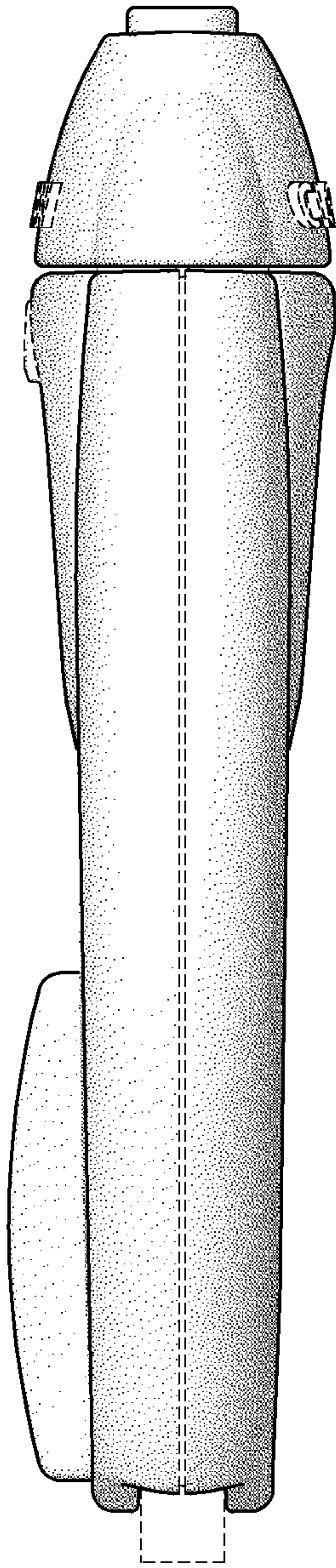

FIG. 6

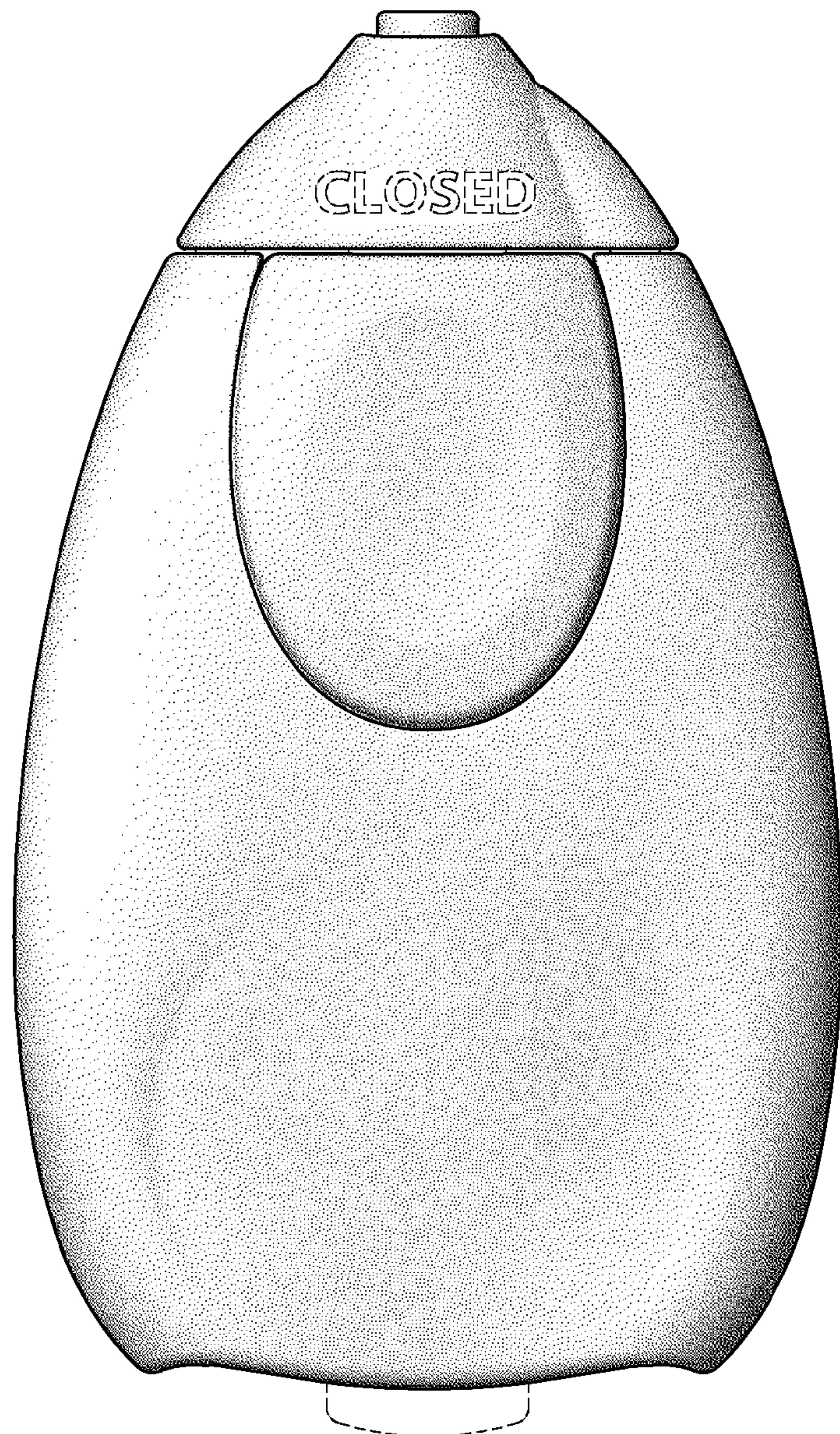

FIG. 7