



US00D559608S

(12) **United States Design Patent**  
**Wu et al.**

(10) **Patent No.:** **US D559,608 S**  
(45) **Date of Patent:** **\*\* Jan. 15, 2008**

(54) **SEAT**  
(75) Inventors: **Amanda Wu**, Seattle, WA (US);  
**Russell Borgmann**, Bellevue, WA  
(US); **Robert Hubler**, Woodinville, WA  
(US); **Oliver Grabes**, Seattle, WA (US)  
(73) Assignee: **Hyperion Innovations Inc.**, Bellevue,  
WA (US)  
(\*\*) Term: **14 Years**  
(21) Appl. No.: **29/229,422**  
(22) Filed: **May 6, 2005**  
(51) **LOC (8) Cl.** ..... **06-09**  
(52) **U.S. Cl.** ..... **D6/601**  
(58) **Field of Classification Search** ..... D6/595,  
D6/596, 601, 604, 605; 5/500, 617, 621,  
5/624, 630, 632, 636, 637, 644, 645, 648,  
5/655.3, 655.9, 652-655, 710, 722; 297/284.1;  
441/85; 267/143, 145; D99/25; 392/435  
See application file for complete search history.

(56) **References Cited**

**U.S. PATENT DOCUMENTS**

1,499,166 A \* 6/1924 Frazier ..... 267/143

(Continued)

**OTHER PUBLICATIONS**

COLDHEAT—Trademark Serial No. 78497299, Oct. 4, 2004  
Hyperion Innovations Inc. Trademark Electronic Service System  
(TESS), available at [www.uspto.gov](http://www.uspto.gov).\*

*Primary Examiner*—Robert M. Spear  
*Assistant Examiner*—Mary Ann Calabrese  
(74) *Attorney, Agent, or Firm*—Perkins Coie, LLP

(57) **CLAIM**

The ornamental design for a seat, as shown and described.

**DESCRIPTION**

FIG. 1 is a top plan view of a seat according to one  
embodiment of the invention showing my new design;

FIG. 2 is a bottom plan view thereof;  
FIG. 3 is a left side view thereof;  
FIG. 4 is a right side view thereof;  
FIG. 5 is a front view thereof;  
FIG. 6 is a back view thereof  
FIG. 7 is a top plan view of a seat according to a second  
embodiment of the invention;  
FIG. 8 is a bottom plan view thereof  
FIG. 9 is a left side view thereof;  
FIG. 10 is a right side view thereof;  
FIG. 11 is a front view thereof;  
FIG. 12 is a back view thereof;  
FIG. 13 is a top plan view of a seat according to a third  
embodiment of the invention;  
FIG. 14 is a bottom plan view thereof;  
FIG. 15 is a left side view thereof;  
FIG. 16 is a right side view thereof;  
FIG. 17 is a front view thereof;  
FIG. 18 is a back view thereof;  
FIG. 19 is a top plan view of seat according to a fourth  
embodiment of the invention;  
FIG. 20 is a bottom plan view thereof;  
FIG. 21 is a left side view thereof;  
FIG. 22 is a right side view thereof;  
FIG. 23 is a front view thereof;  
FIG. 24 is a back view thereof;  
FIG. 25 is a top plan view of a set according to a fifth  
embodiment of the invention;  
FIG. 26 is a bottom plan view thereof;  
FIG. 27 is a left side view thereof;  
FIG. 28 is a right side view thereof;  
FIG. 29 is a front view thereof; and,  
FIG. 30 is a back view thereof.

In the drawings, the broken lines represent environmental  
structure forming no part of the claim.

**1 Claim, 20 Drawing Sheets**

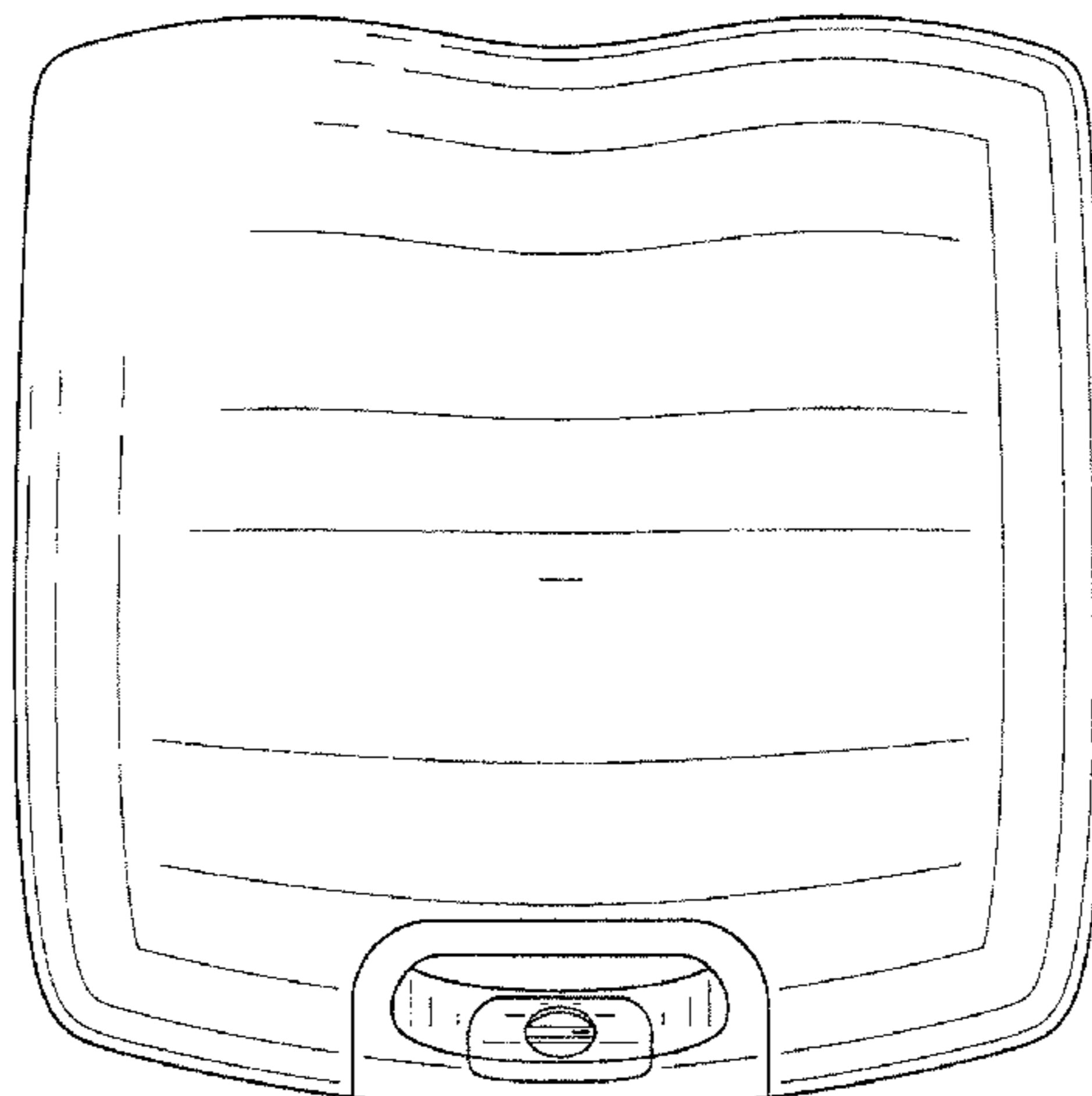

# US D559,608 S

Page 2

---

## U.S. PATENT DOCUMENTS

1,551,452	A *	8/1925	Arias .....	267/145	D294,793	S *	3/1988	Luccisano .....	D6/601
3,323,151	A *	6/1967	Lerman .....	5/722	D356,920	S *	4/1995	Luccisano .....	D6/601
3,378,865	A *	4/1968	Pigg .....	441/85	D391,111	S *	2/1998	Graebe et al. ....	D6/601
4,250,397	A *	2/1981	Gray et al. ....	392/435	D447,850	S *	9/2001	Escobedo .....	D99/25
D260,125	S *	8/1981	Rogers .....	D6/596	2001/0003219	A1 *	6/2001	Chou .....	5/636
4,660,238	A *	4/1987	Jay .....	5/654					

\* cited by examiner

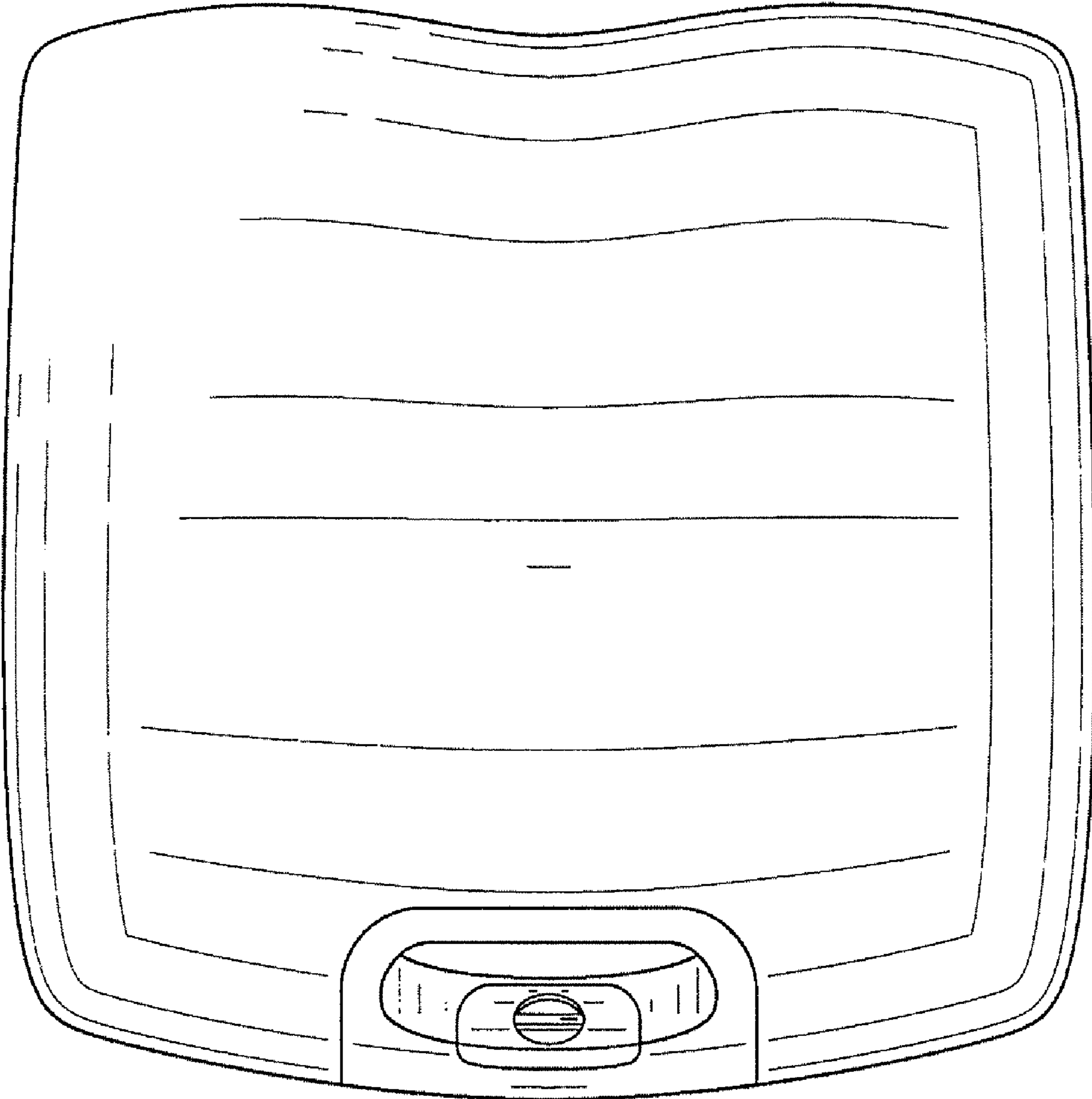

FIG. 1

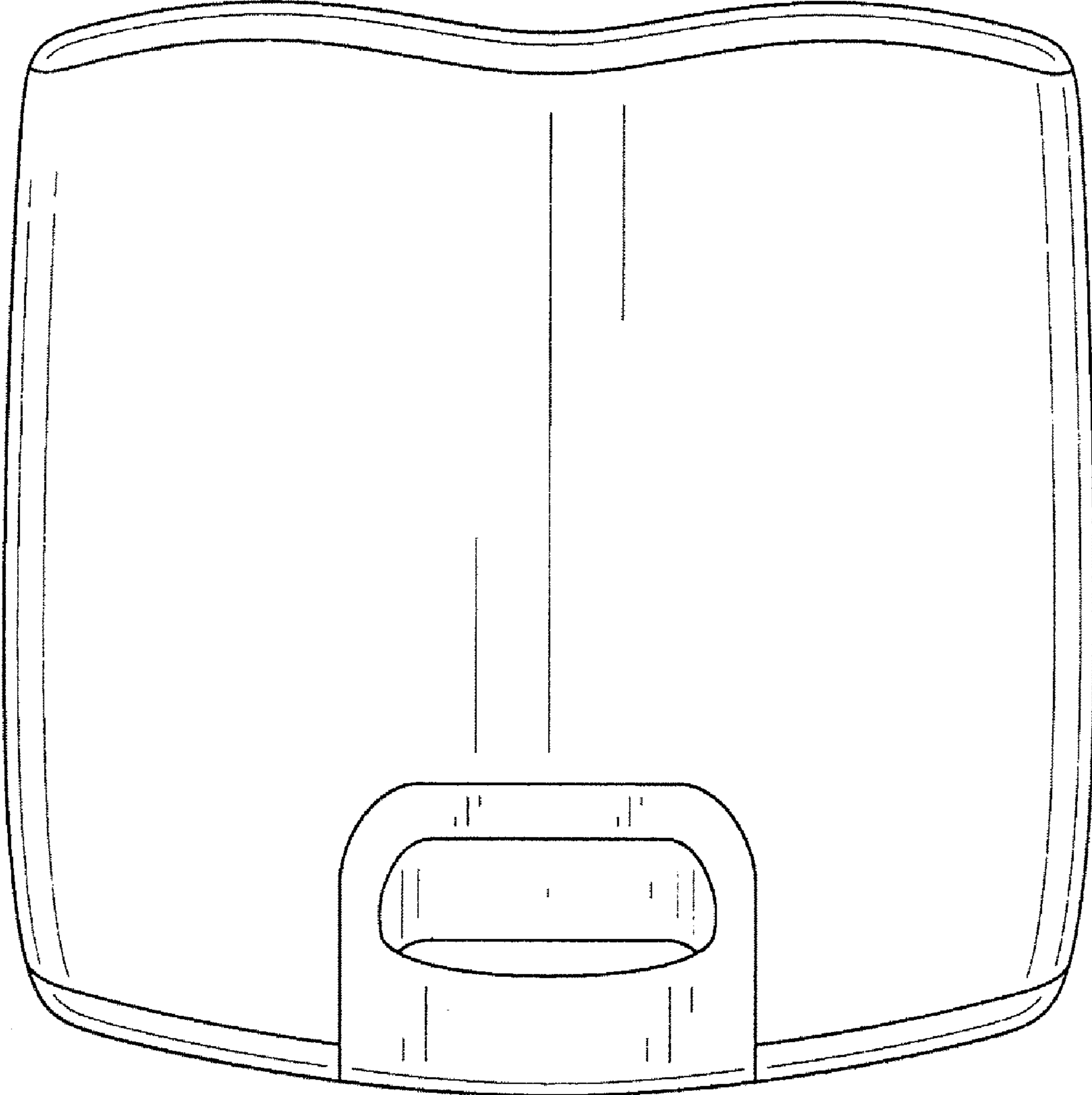

FIG. 2

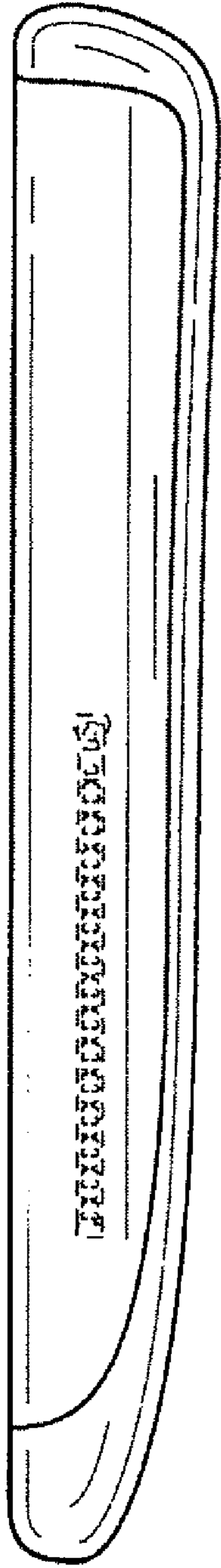

FIG. 3

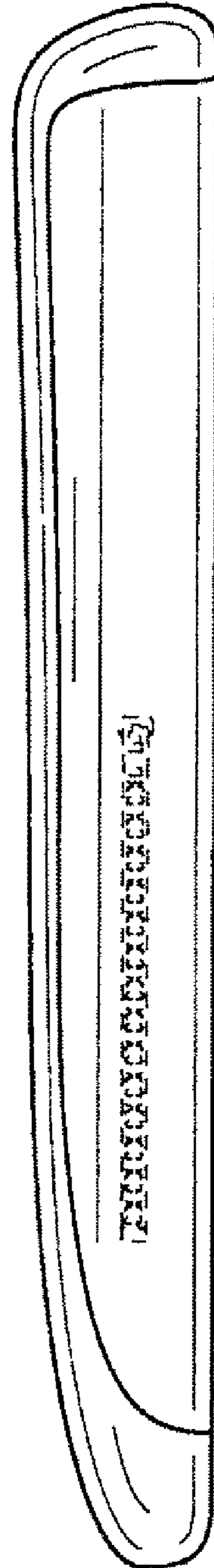

FIG. 4

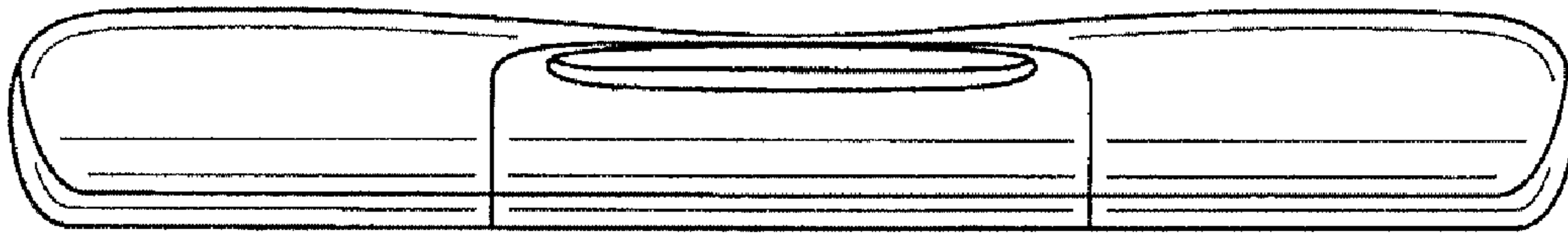

FIG. 5

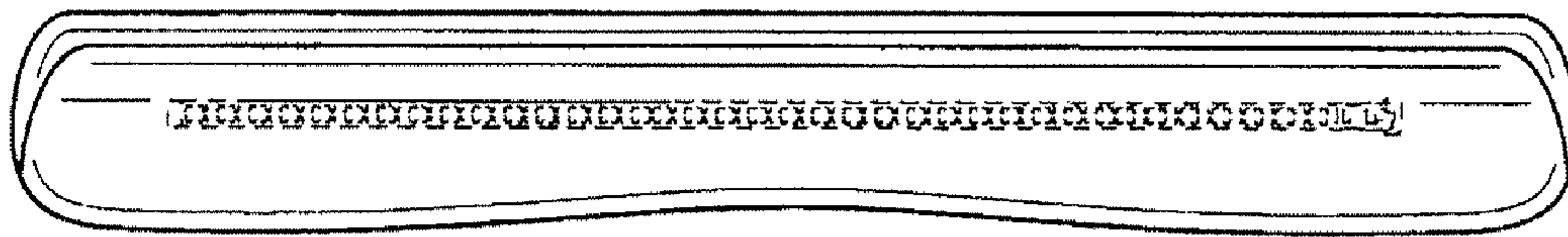

FIG. 6

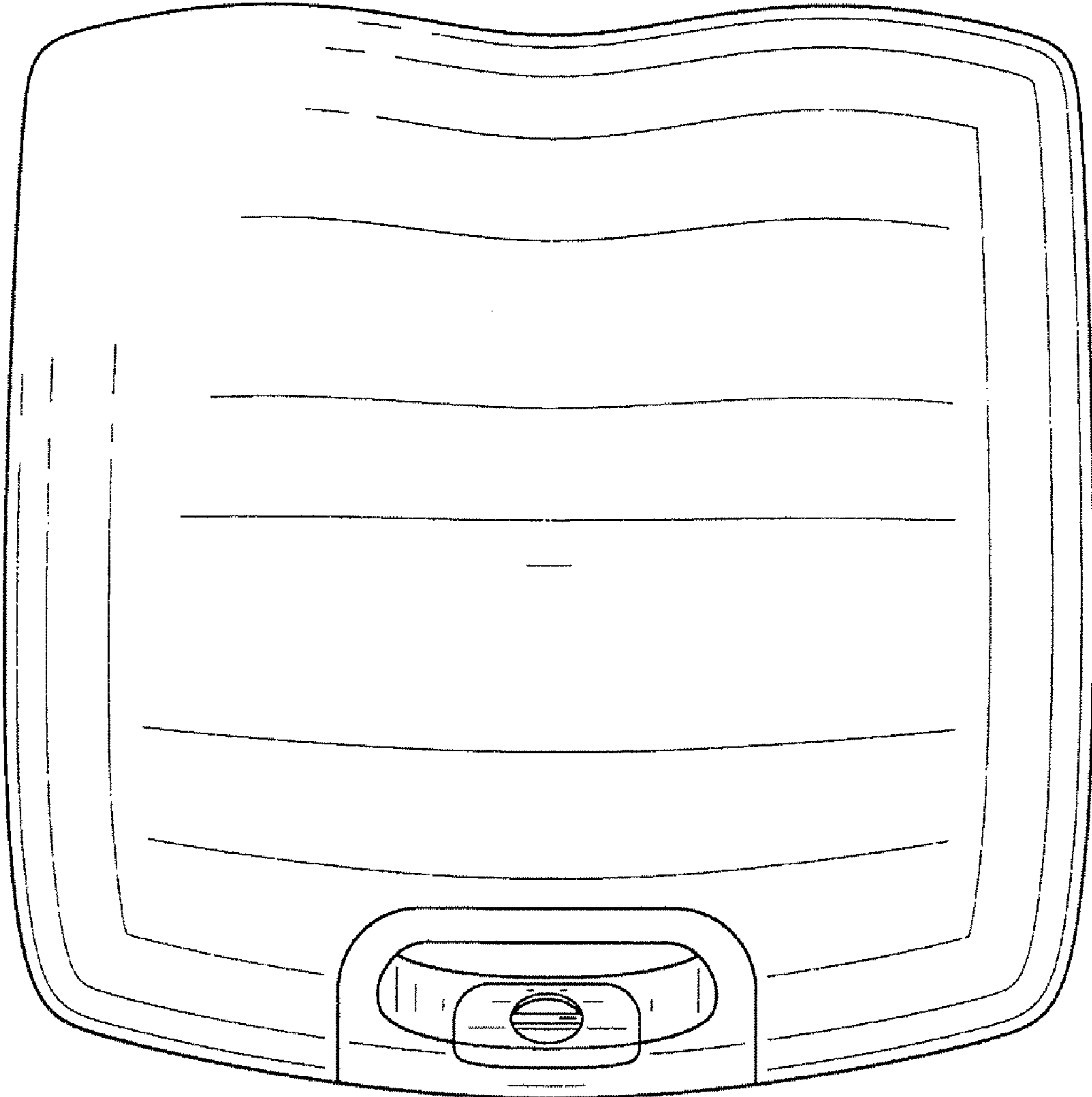

FIG. 7

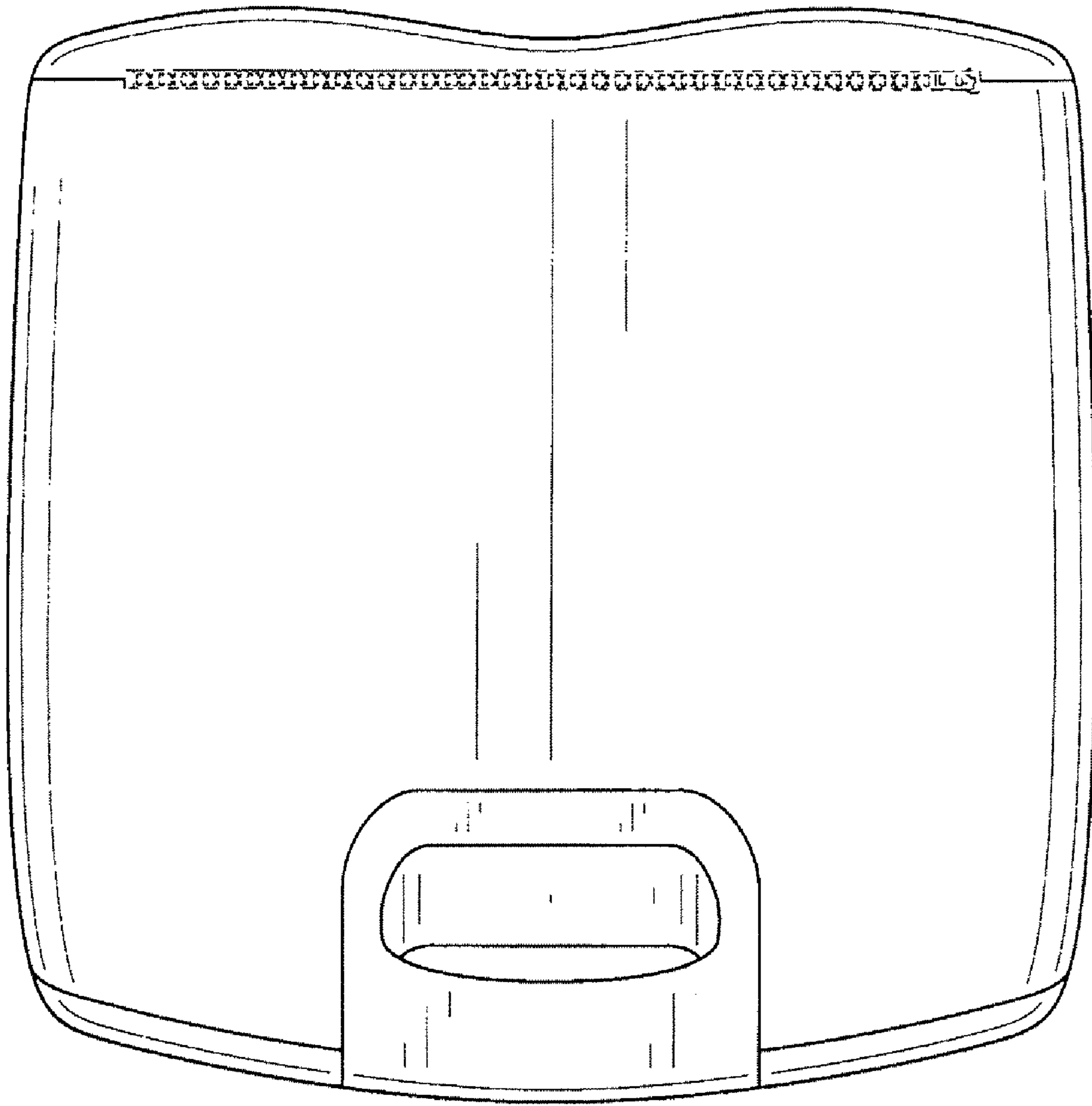

FIG. 8



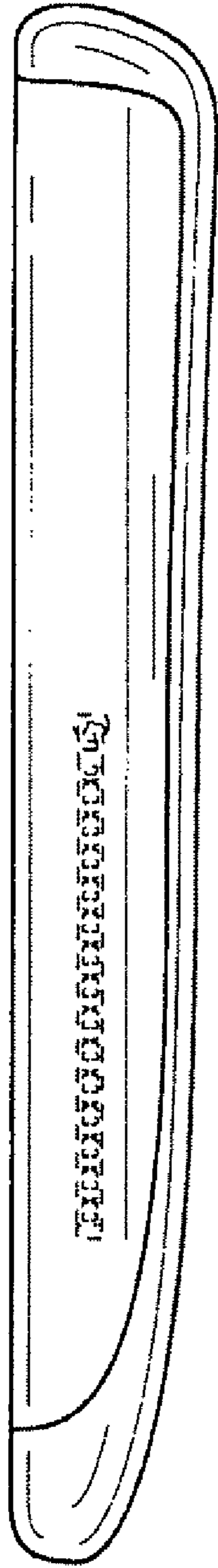

FIG. 9

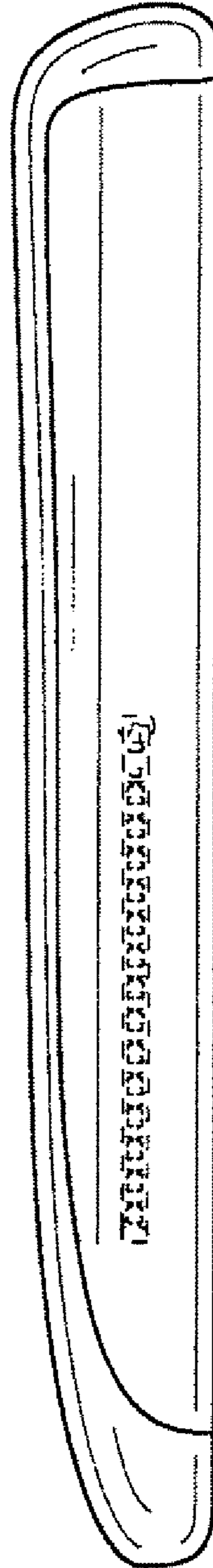

FIG. 10

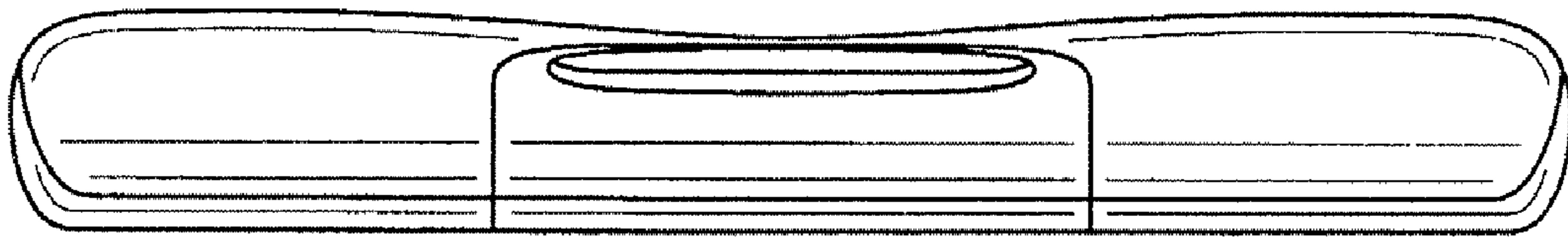

FIG. 11

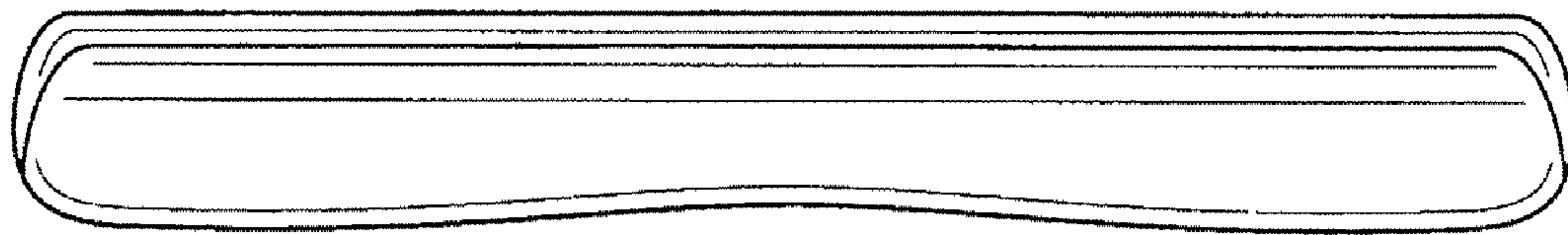

FIG. 12

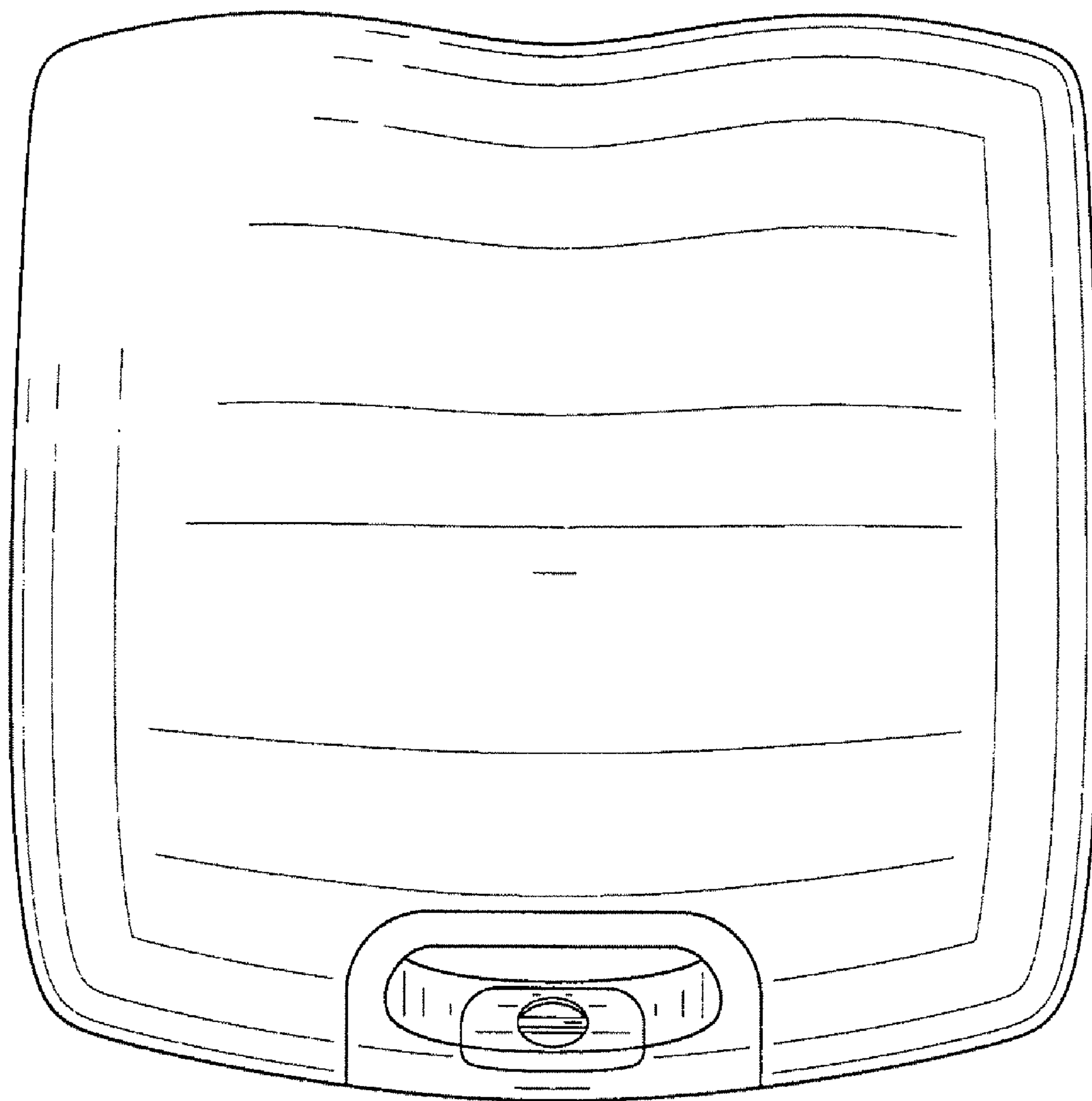

FIG. 13

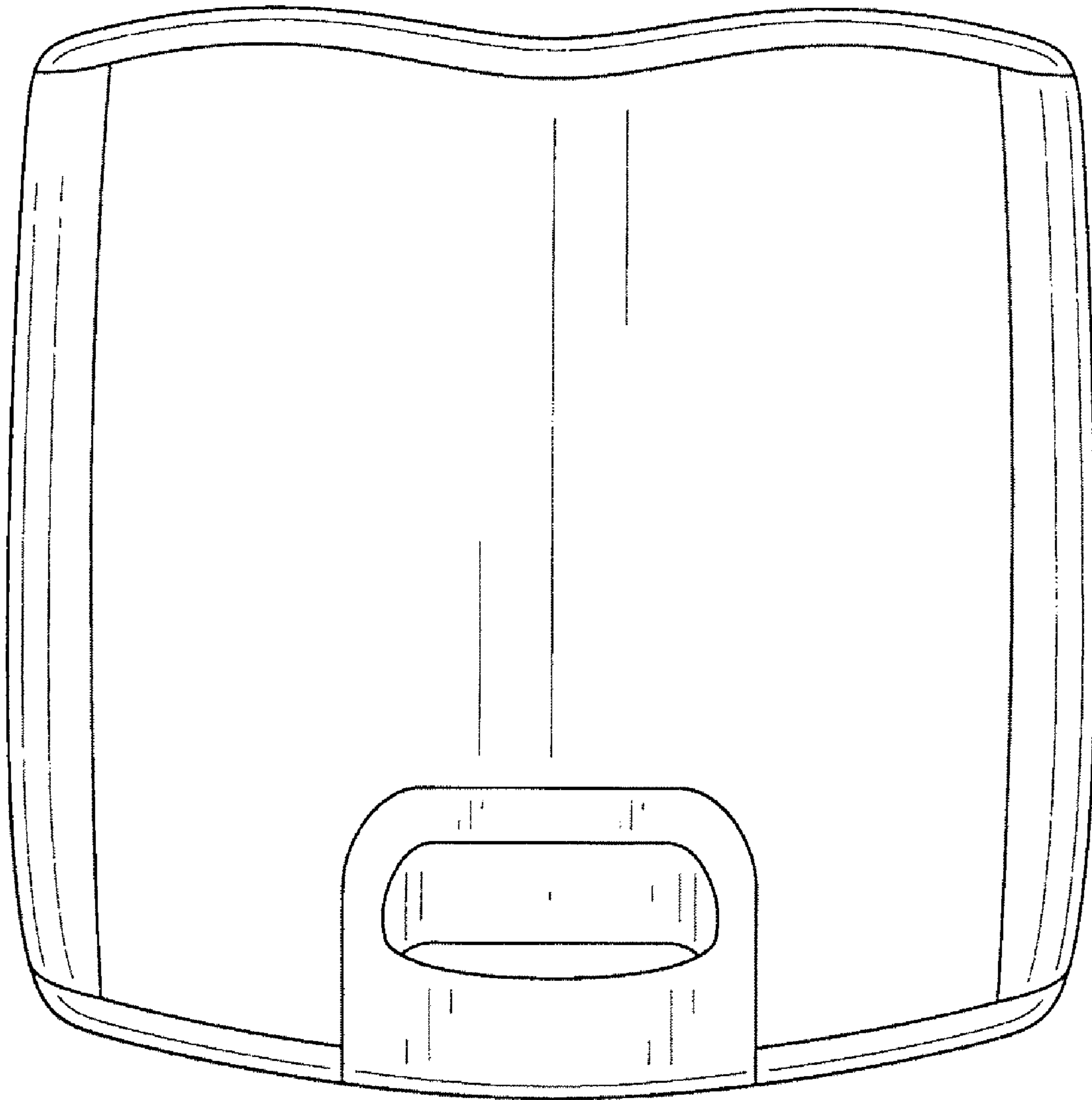

FIG. 14

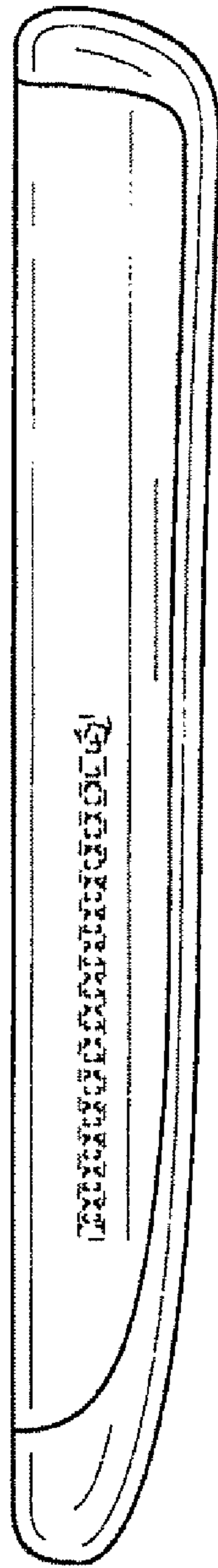

FIG. 15

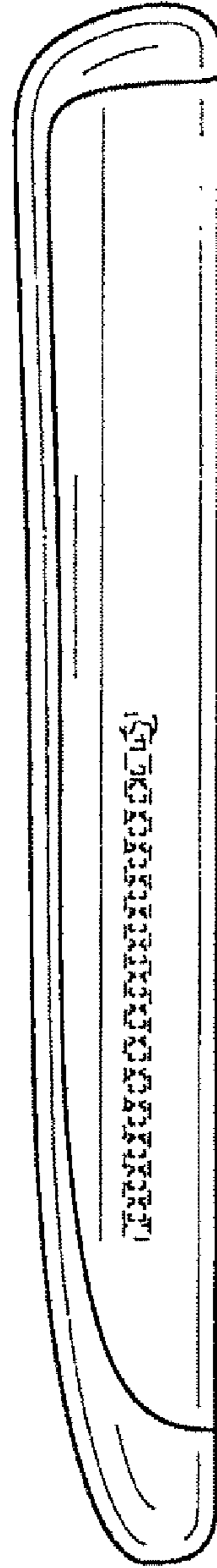

FIG. 16

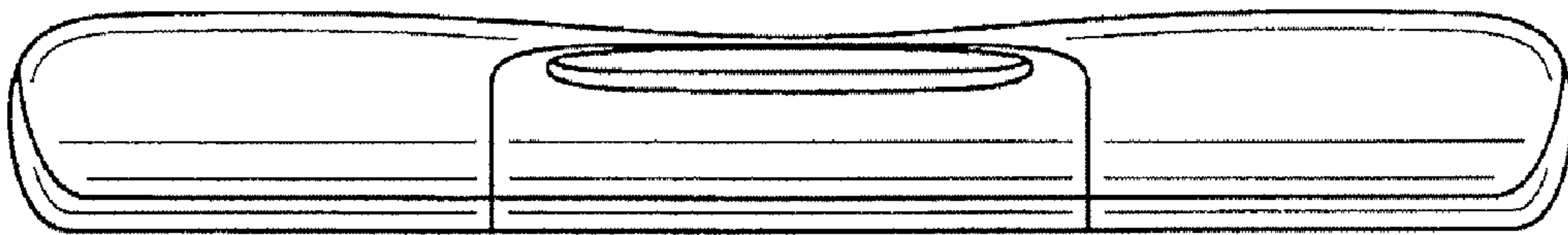

FIG. 17

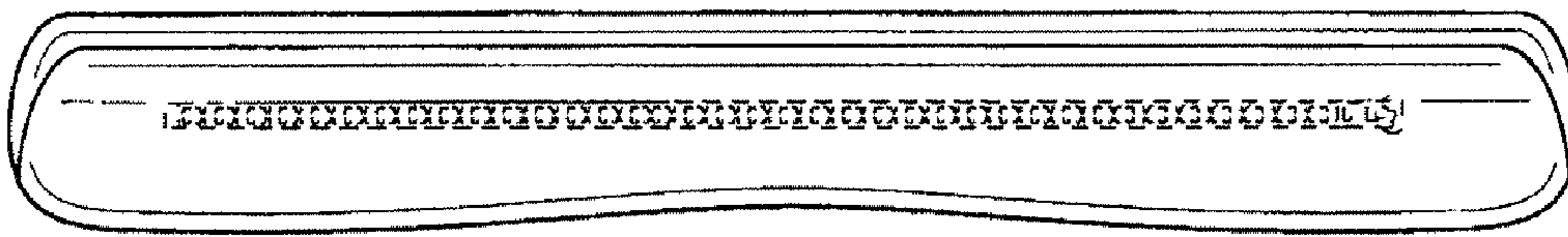

FIG. 18

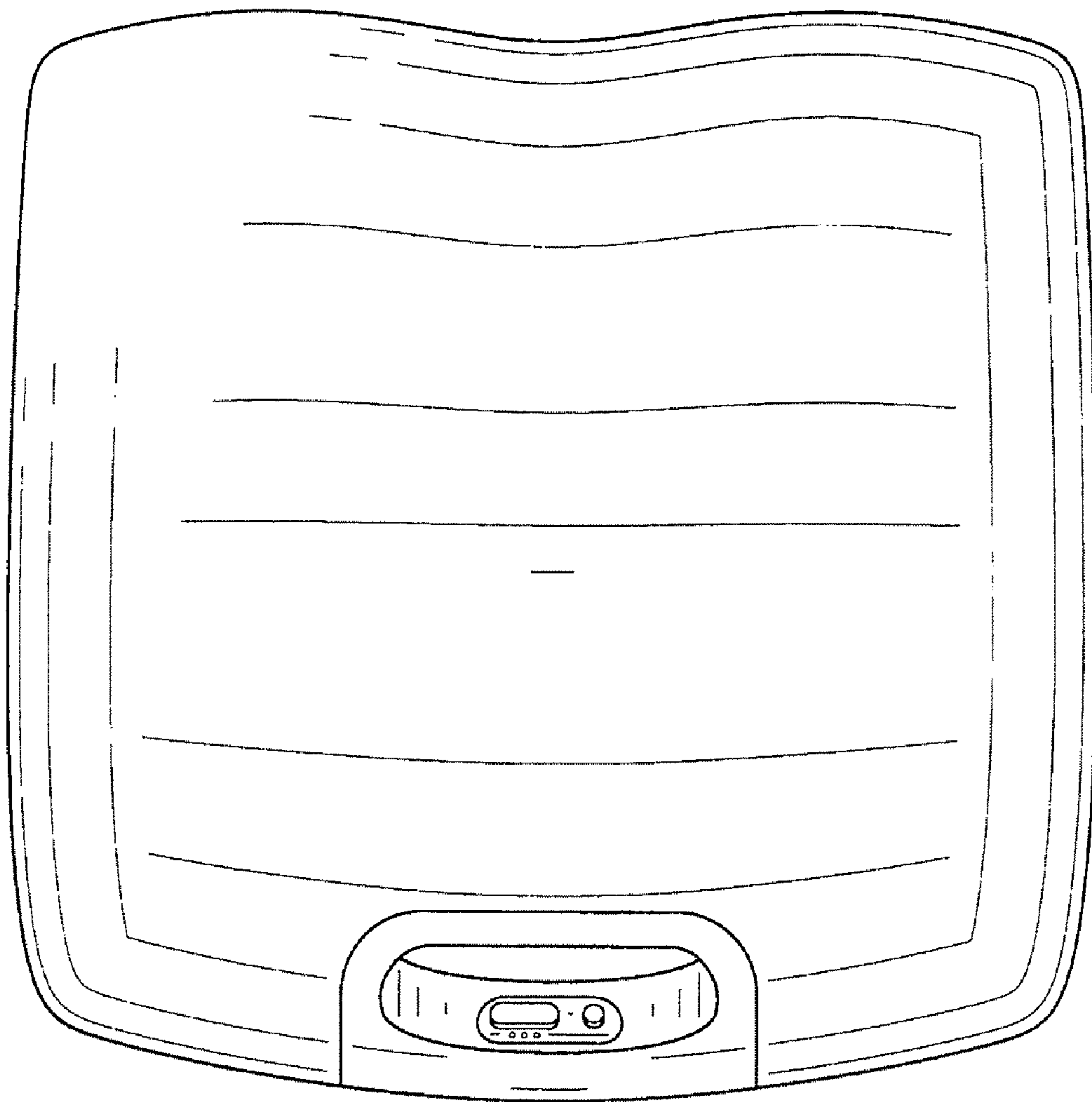

FIG. 19

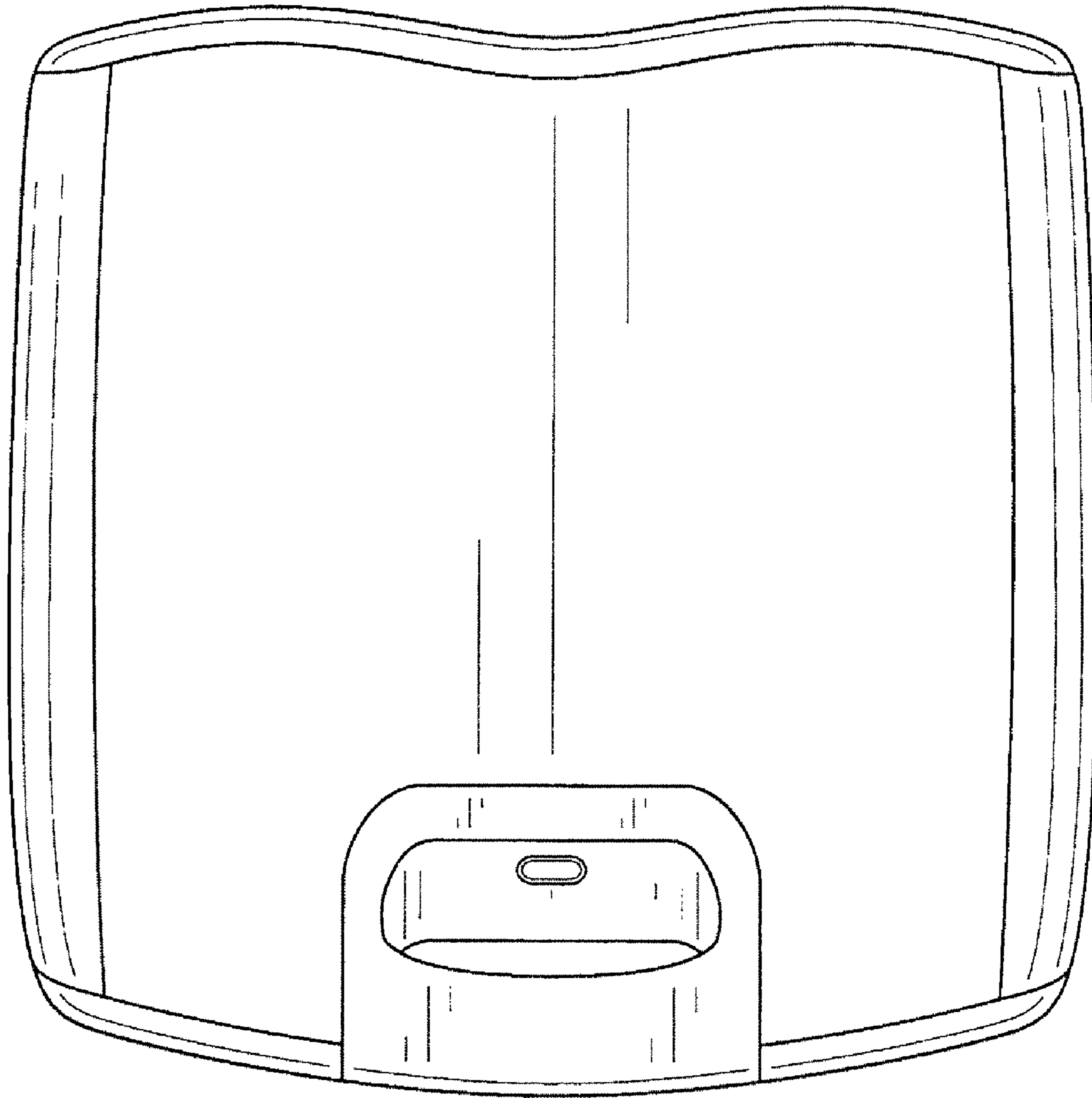

FIG. 20



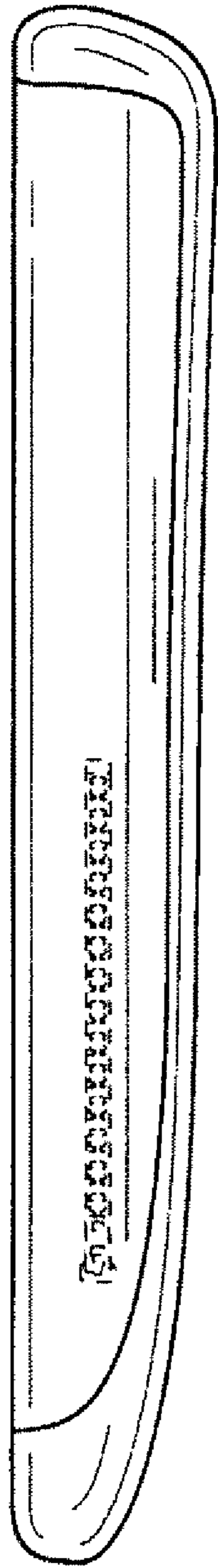

FIG. 21

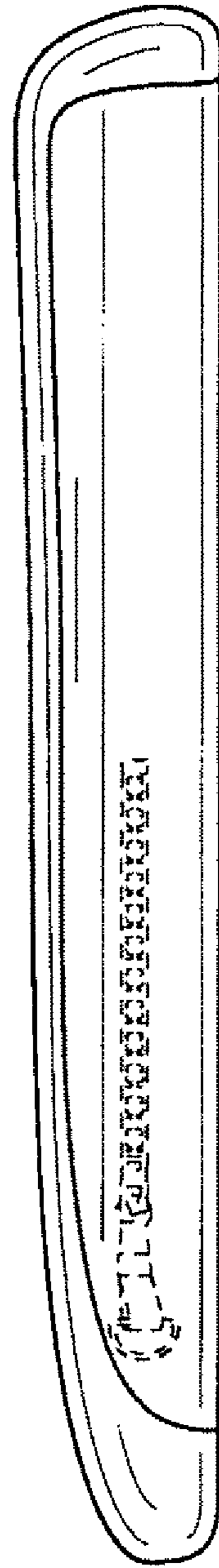

FIG. 22

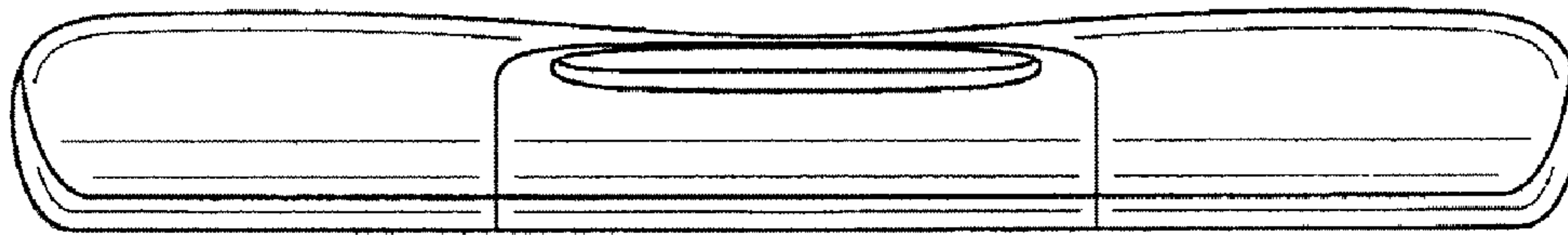

FIG. 23

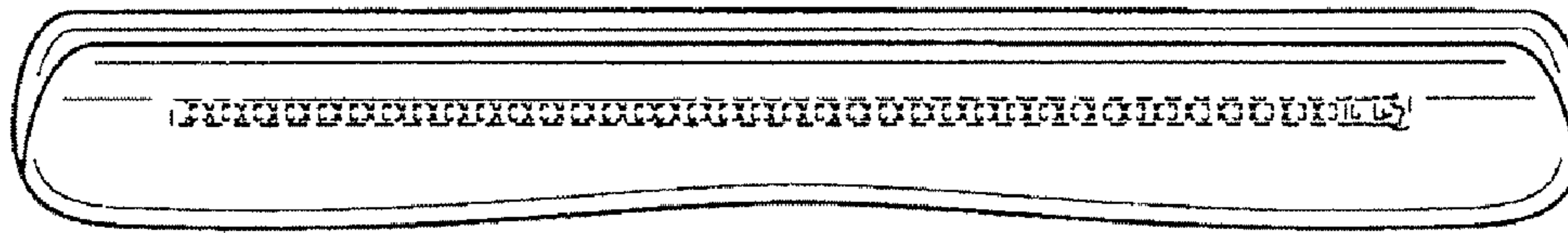

FIG. 24

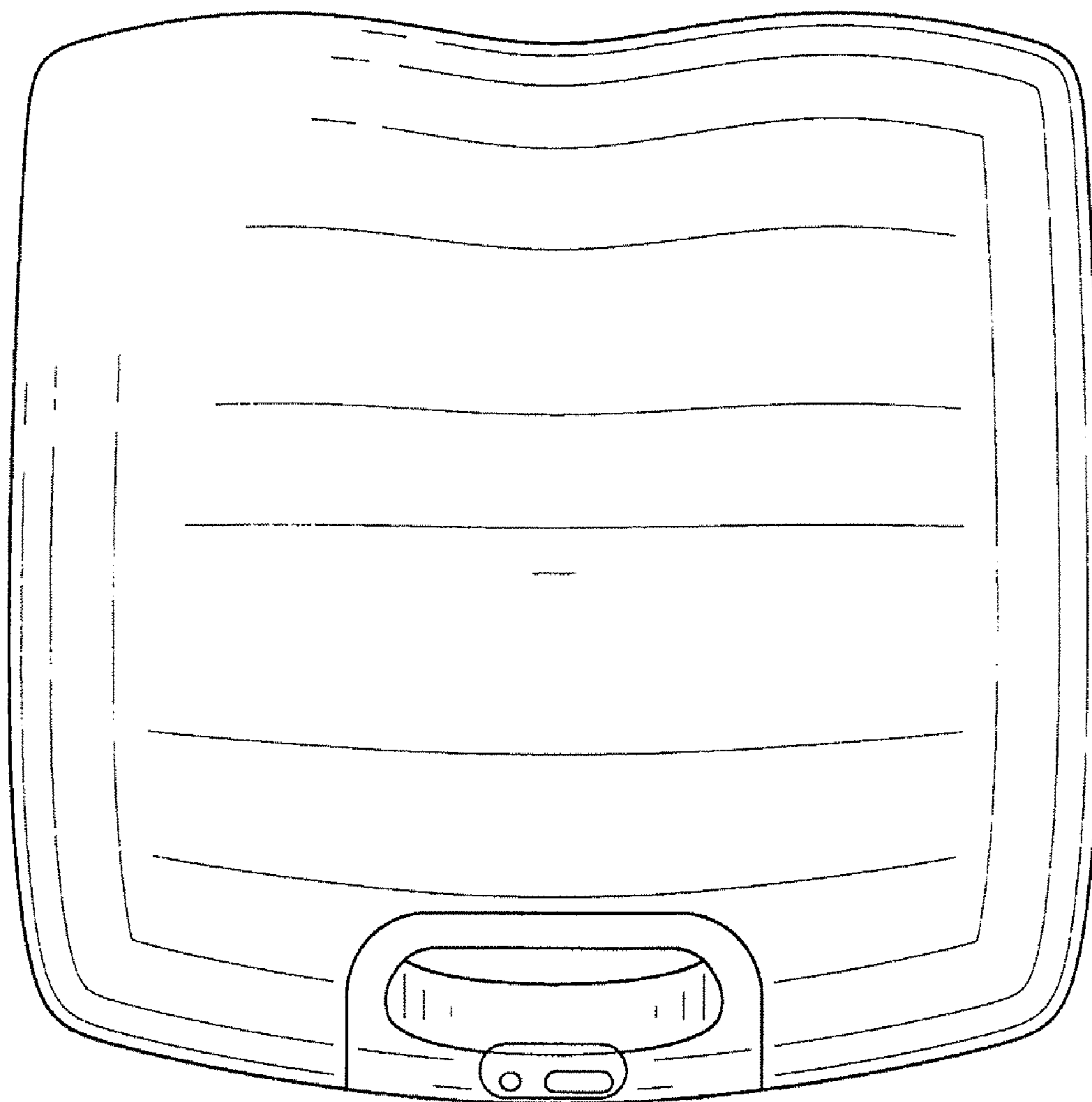

FIG. 25

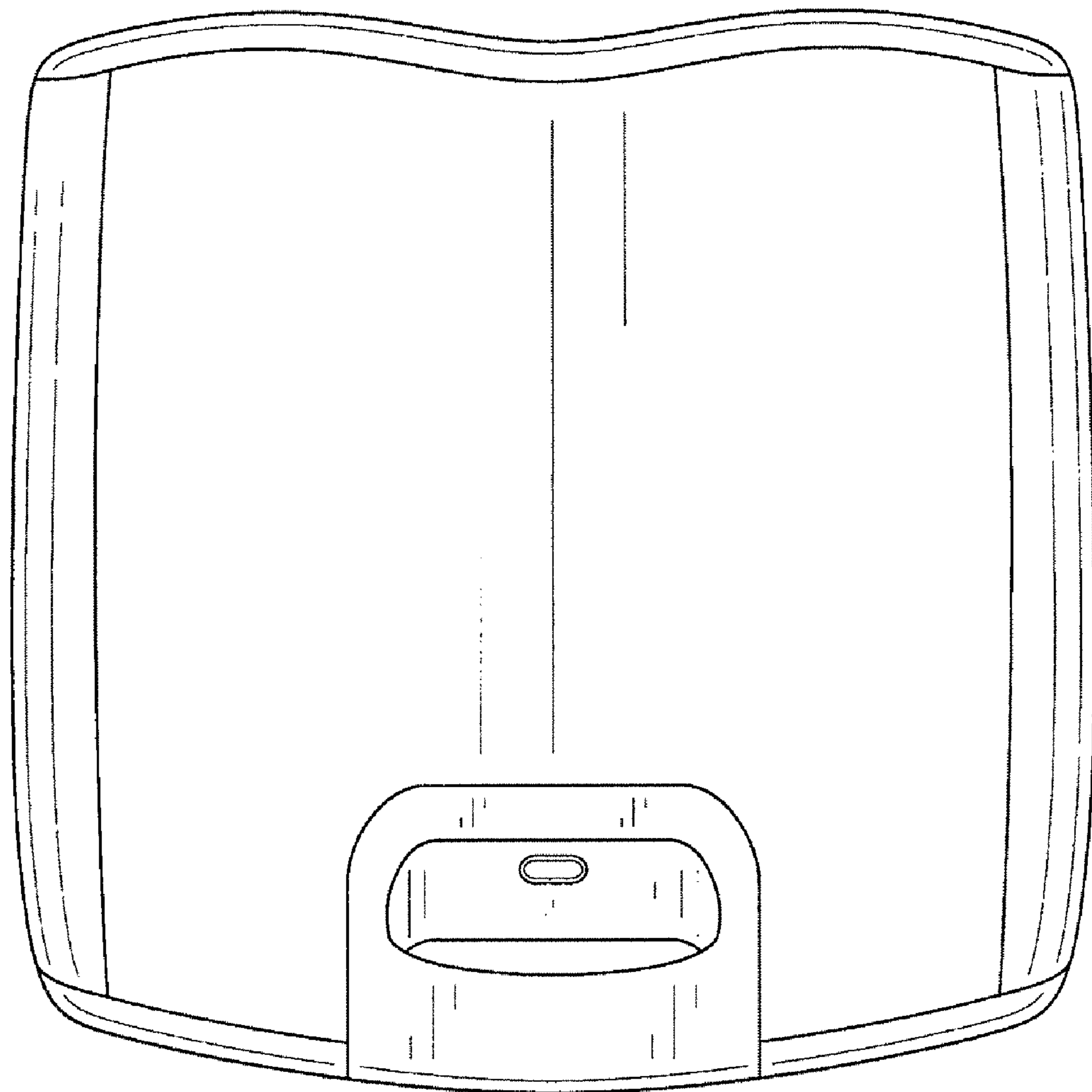

FIG. 26

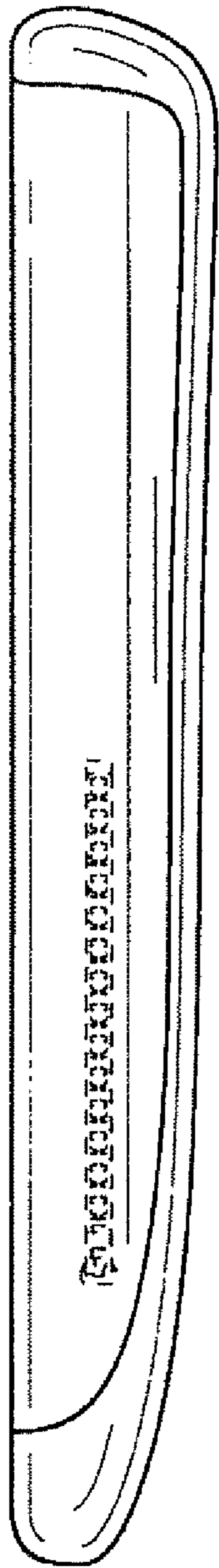

FIG. 27

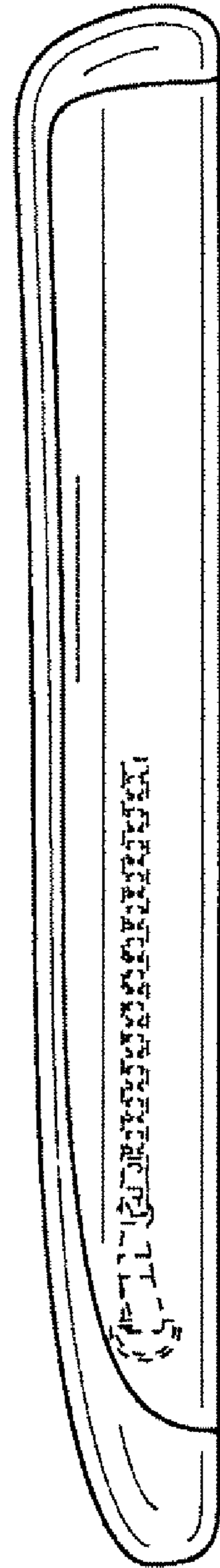

FIG. 28

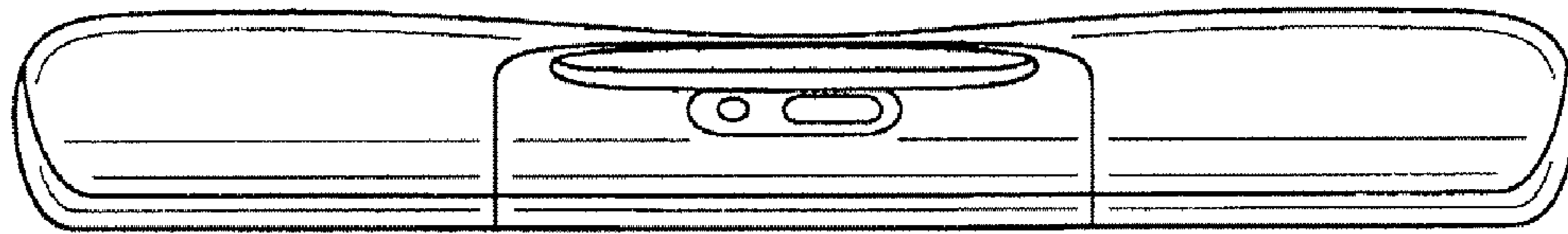

FIG. 29

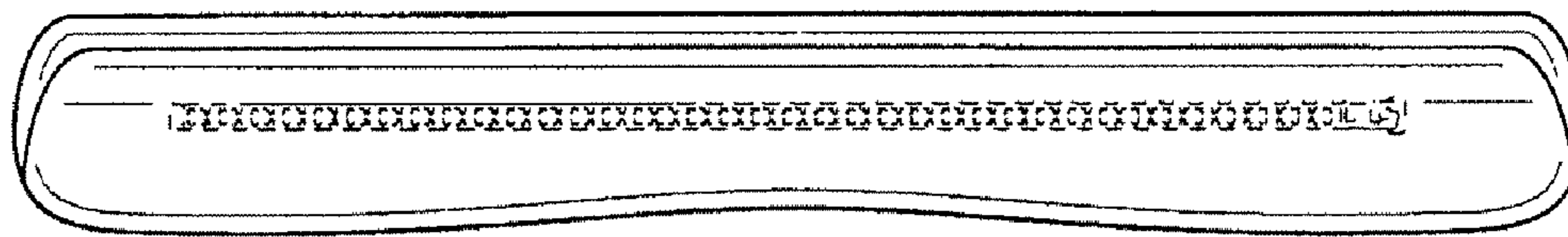

FIG. 30