



US00D559570S

(12) **United States Design Patent**
Higgs et al.

(10) **Patent No.:** **US D559,570 S**
(45) **Date of Patent:** **** Jan. 15, 2008**

(54) **CHAIR**

(75) Inventors: **Steve Higgs**, Lane Cove (AU); **David Russell King**, Turrella (AU)

(73) Assignee: **King Furniture (Australia) Pty. Ltd.**, Turrella, New South Wales (AU)

(**) Term: **14 Years**

(21) Appl. No.: **29/258,260**

(22) Filed: **Apr. 19, 2006**

(30) **Foreign Application Priority Data**

Dec. 21, 2005 (AU) 15677/2005
Dec. 21, 2005 (AU) 15683/2005

(51) **LOC (8) Cl.** **06-01**

(52) **U.S. Cl.** **D6/364**

(58) **Field of Classification Search** D6/364,
D6/379, 500-502, 380, 374-375, 334-336;
297/423.1, 445.1

See application file for complete search history.

(56) **References Cited**

U.S. PATENT DOCUMENTS

D145,092 S * 6/1946 Laskowitz D6/361
D166,402 S * 4/1952 Manne et al. D6/361
D171,364 S * 1/1954 Parker D3/361
D191,164 S * 8/1961 Sher D6/361
D201,276 S * 6/1965 Peter D6/361

D227,952 S * 7/1973 Costabile D6/364
D235,593 S * 7/1975 Pearson D6/364
D335,037 S * 4/1993 Montague, III et al. D6/364
D372,132 S * 7/1996 Infanti D6/367
D403,168 S * 12/1998 Guibelalde D6/364
D508,791 S * 8/2005 Natuzzi D6/364
D509,371 S * 9/2005 Natuzzi D6/361

* cited by examiner

Primary Examiner—Caron D. Veynar

Assistant Examiner—Abraham Bahta

(74) *Attorney, Agent, or Firm*—D. Peter Hochberg; Sean Mellino

(57) **CLAIM**

The ornamental design for a chair, as shown and described.

DESCRIPTION

FIG. 1 is a perspective view of a chair showing our new design;

FIG. 2 is a left side view thereof;

FIG. 3 is a front elevation view thereof;

FIG. 4 is a rear view thereof;

FIG. 5 is a top plan view thereof; and,

FIG. 6 is a bottom plan view thereof.

The broken lines shown in FIGS. 1-4 and 6 are for illustrative purposes only and form no part of the claimed design.

1 Claim, 6 Drawing Sheets

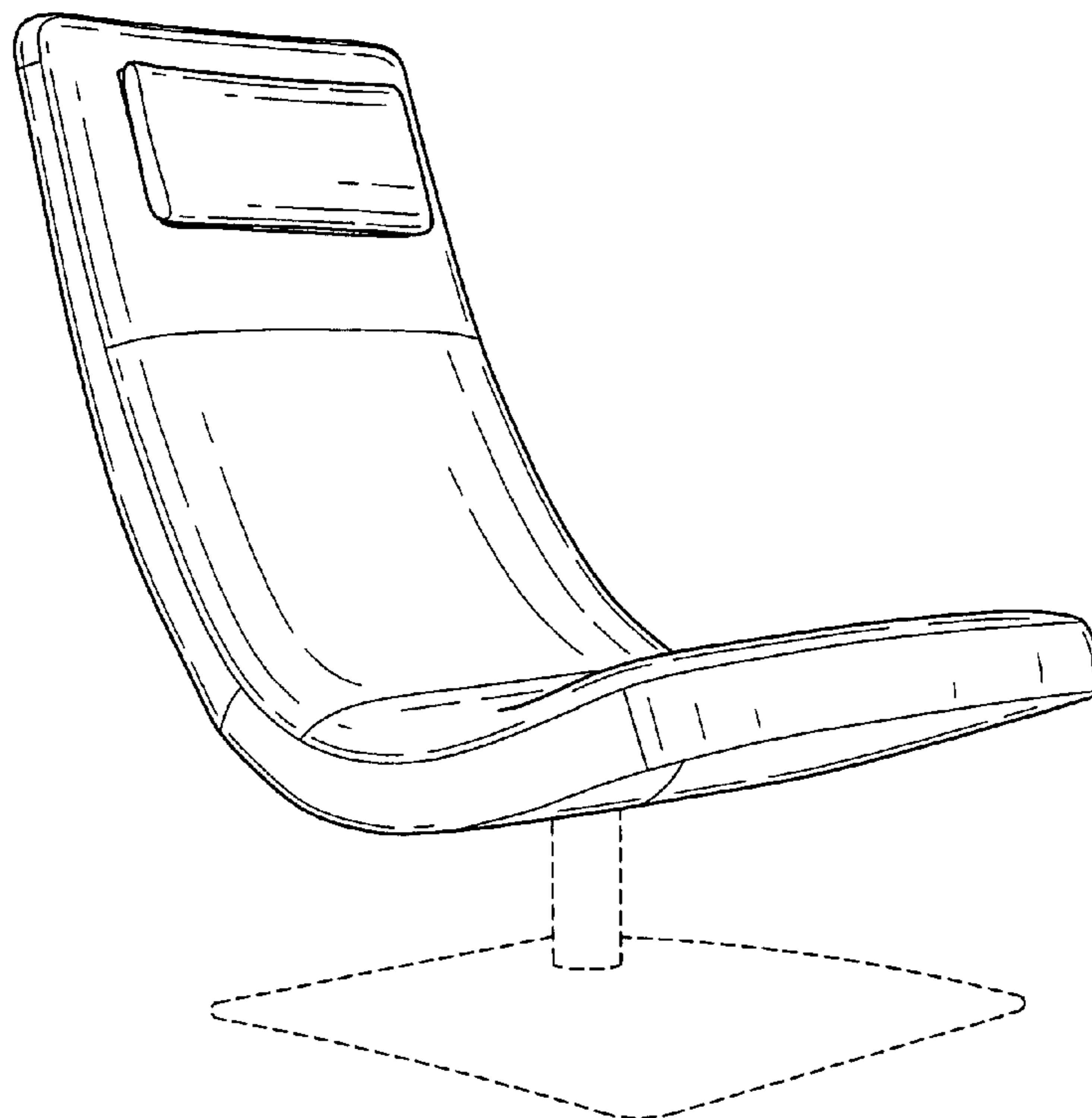

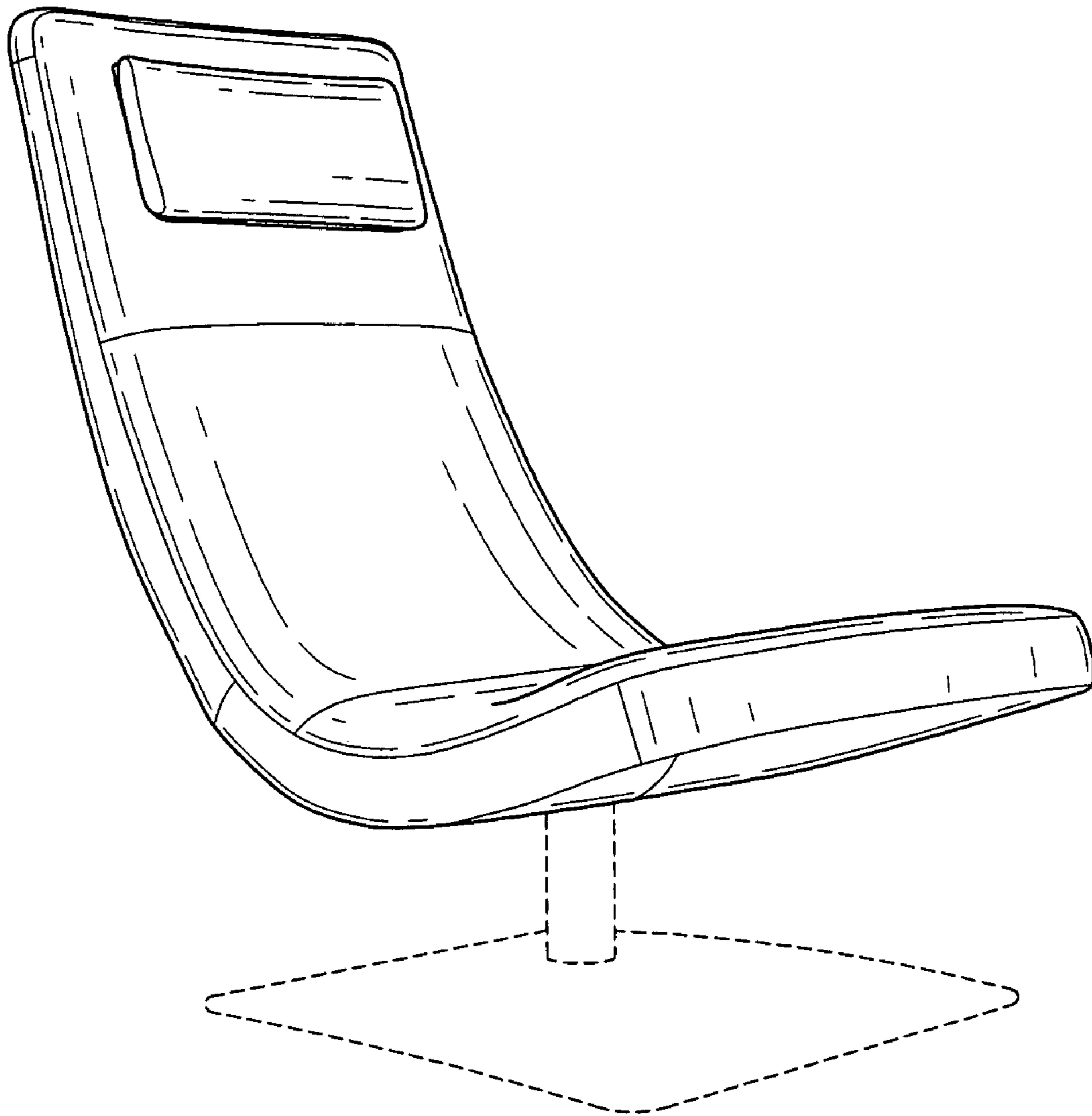

FIG-1

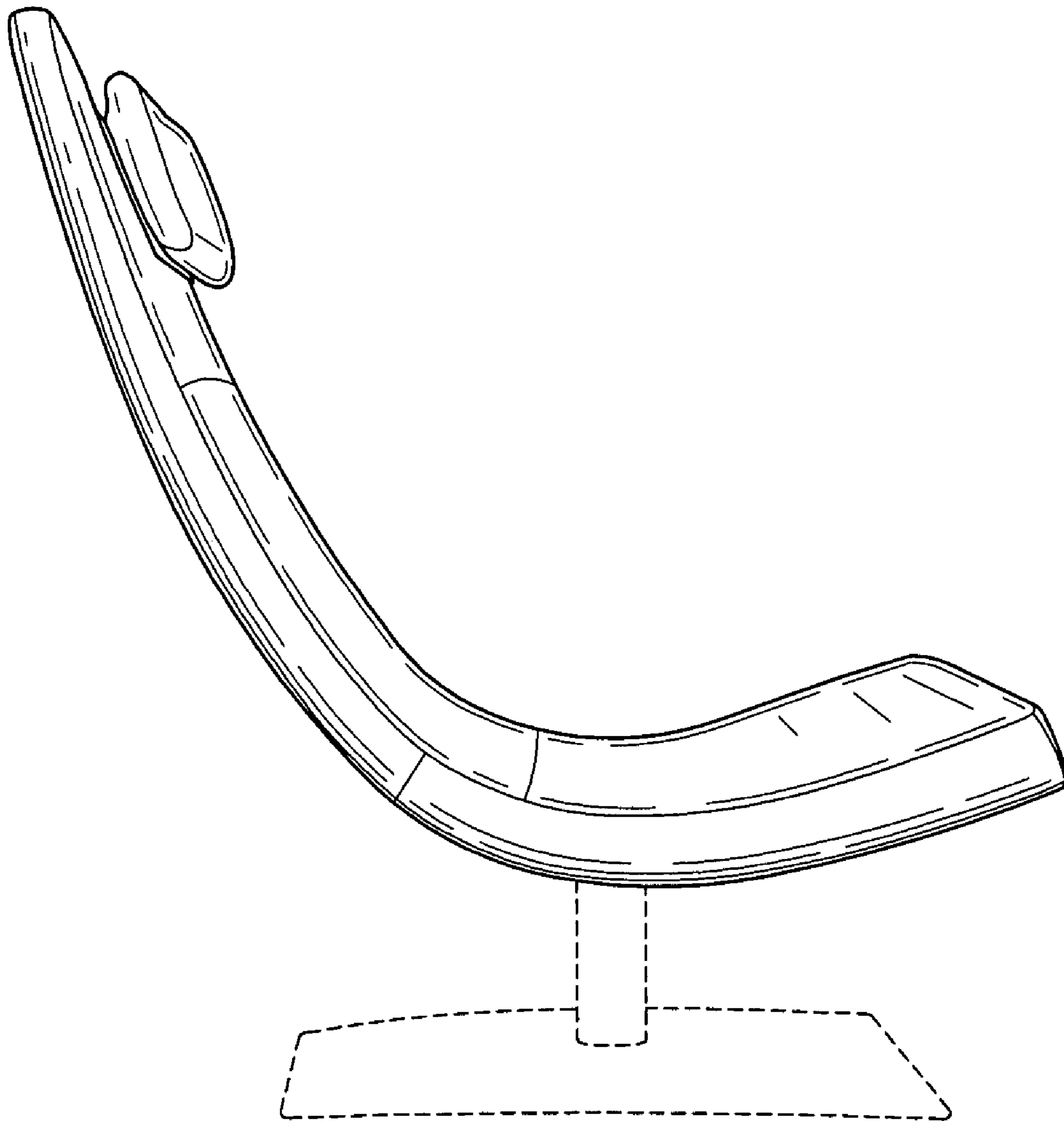

FIG-2

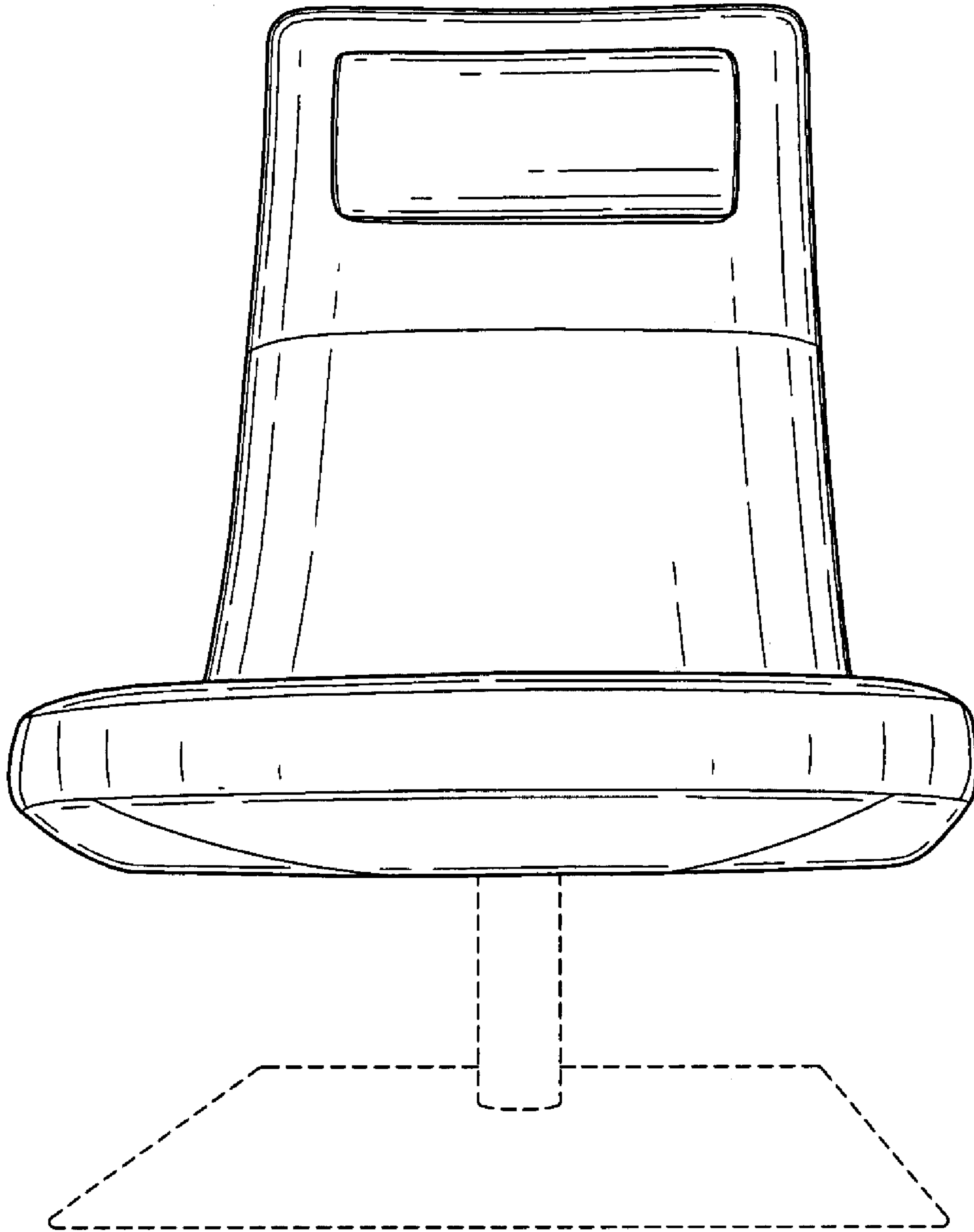

FIG-3

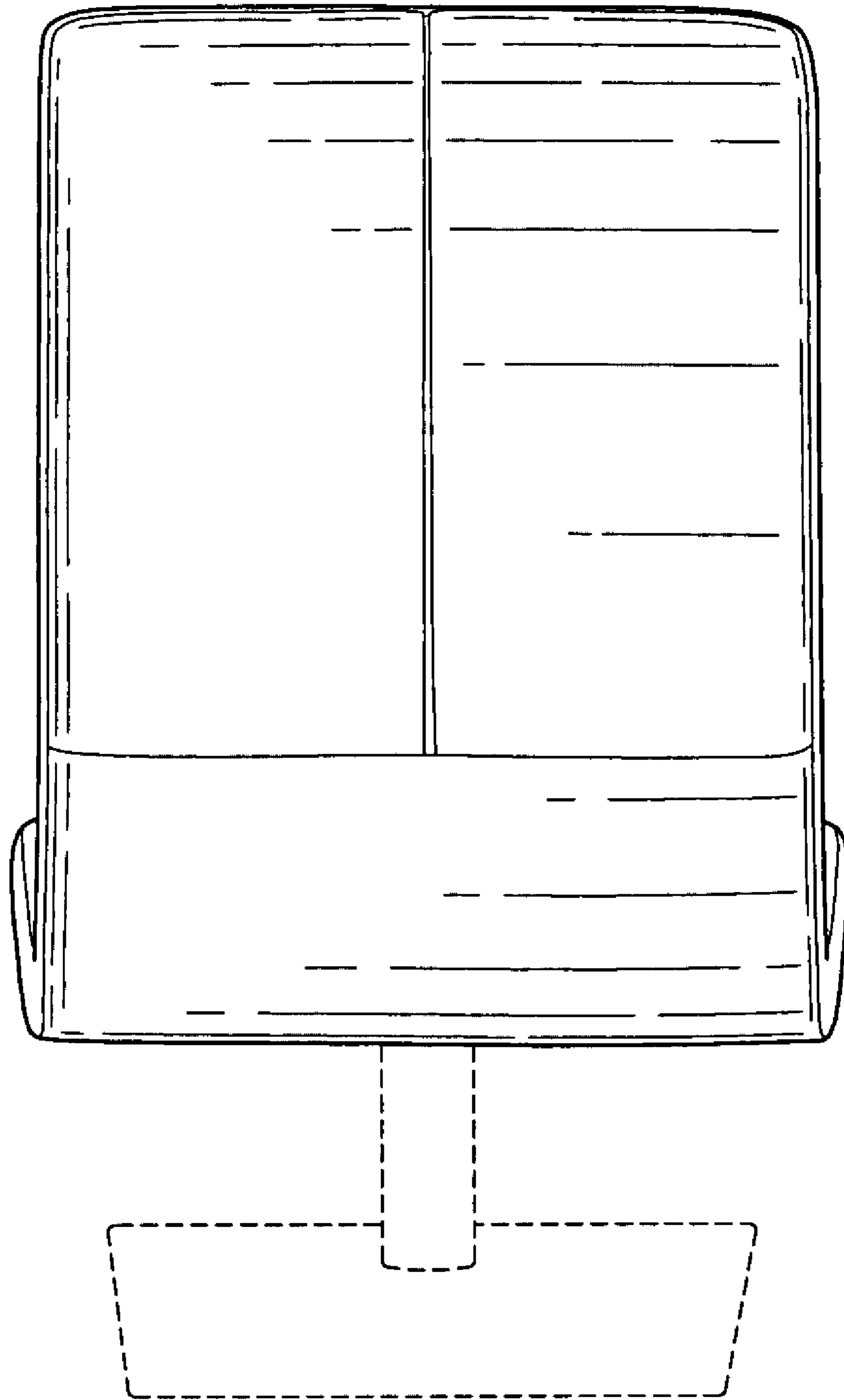

FIG-4

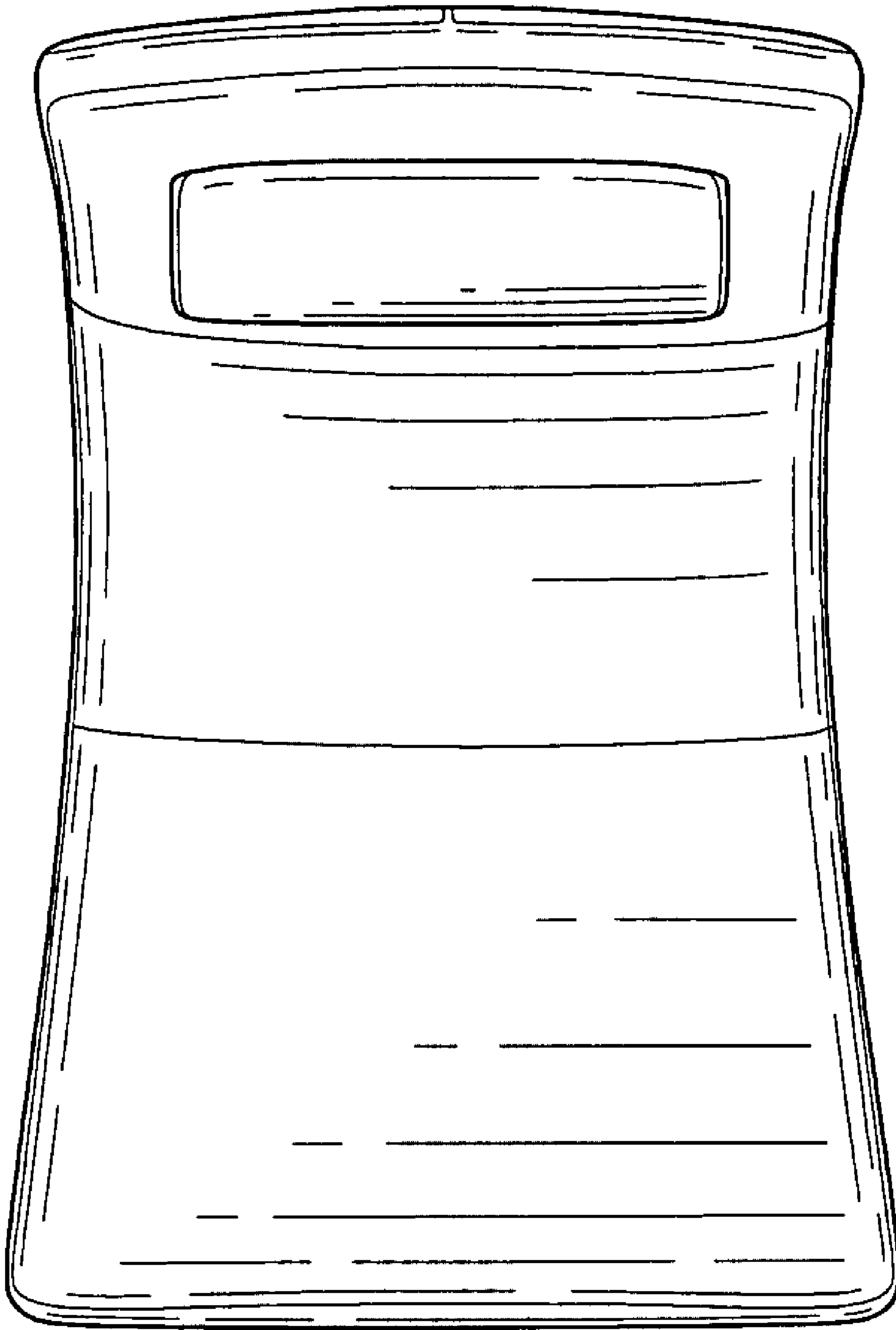

FIG-5

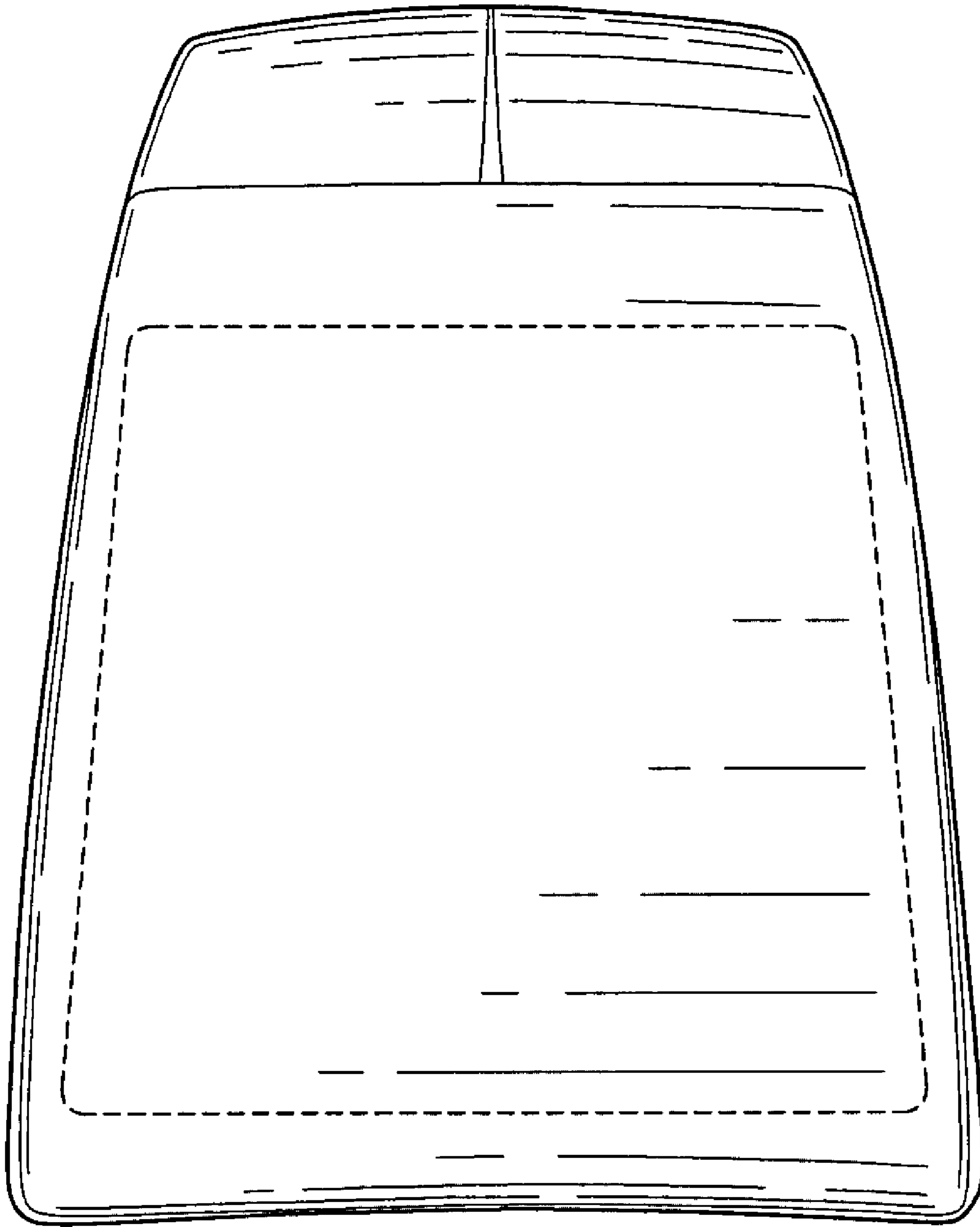

FIG-6