



US00D559485S

(12) **United States Design Patent**
Fjellman

(10) **Patent No.:** **US D559,485 S**

(45) **Date of Patent:** **** Jan. 8, 2008**

(54) **HANDHELD VACUUM BASE**

(75) Inventor: **Oskar Fjellman**, Stockholm (SE)

(73) Assignee: **AB Electrolux**, Stockholm (SE)

(**) Term: **14 Years**

(21) Appl. No.: **29/266,124**

(22) Filed: **Sep. 15, 2006**

(30) **Foreign Application Priority Data**

Mar. 16, 2006 (EM) 497664-0002

(51) **LOC (8) Cl.** **15-05**

(52) **U.S. Cl.** **D32/31; D13/108**

(58) **Field of Classification Search** D13/107-110,
D13/118-119, 184; D14/251, 253, 432,
D14/434; D32/25, 31; 320/107-115
See application file for complete search history.

(56) **References Cited**

U.S. PATENT DOCUMENTS

D210,885 S *	4/1968	Eberhart	D13/108
4,225,814 A *	9/1980	Gantz et al.	320/115
D289,631 S *	5/1987	Osit	D13/108
D300,214 S *	3/1989	Adams	D13/108
D303,245 S *	9/1989	Tsuji	D13/108
D308,267 S *	5/1990	Bradd	D32/31
D335,861 S *	5/1993	Tattari	D13/108
D398,425 S	9/1998	Hudson		
D444,449 S *	7/2001	Yamamoto	D13/107
D445,975 S *	7/2001	Stratford	D32/31

D462,950 S *	9/2002	Waffensmith et al.	D14/251
D515,029 S *	2/2006	Hattori	D13/108
2002/0153863 A1 *	10/2002	Arndt	320/115
2005/0017681 A1 *	1/2005	Ogishima et al.	320/112

* cited by examiner

Primary Examiner—M. H. Tung

Assistant Examiner—Rosemary K. Tarcza

(74) *Attorney, Agent, or Firm*—Hunton & Williams

(57) **CLAIM**

The ornamental design for a handheld vacuum base, as shown and described.

DESCRIPTION

FIG. 1 is a front isometric view of a handheld vacuum base showing the claimed design.

FIG. 2 is a front elevational view of the handheld vacuum base.

FIG. 3 is a rear elevational view of the handheld vacuum base.

FIG. 4 is a right elevational view of the handheld vacuum base, the left elevational view being a mirror image of the right elevational view.

FIG. 5 is a top plan view of the handheld vacuum base; and, FIG. 6 is a bottom plan view of the handheld vacuum base.

The broken line showing is included for the purpose of illustrating environment and forms no part of the claimed design.

1 Claim, 6 Drawing Sheets

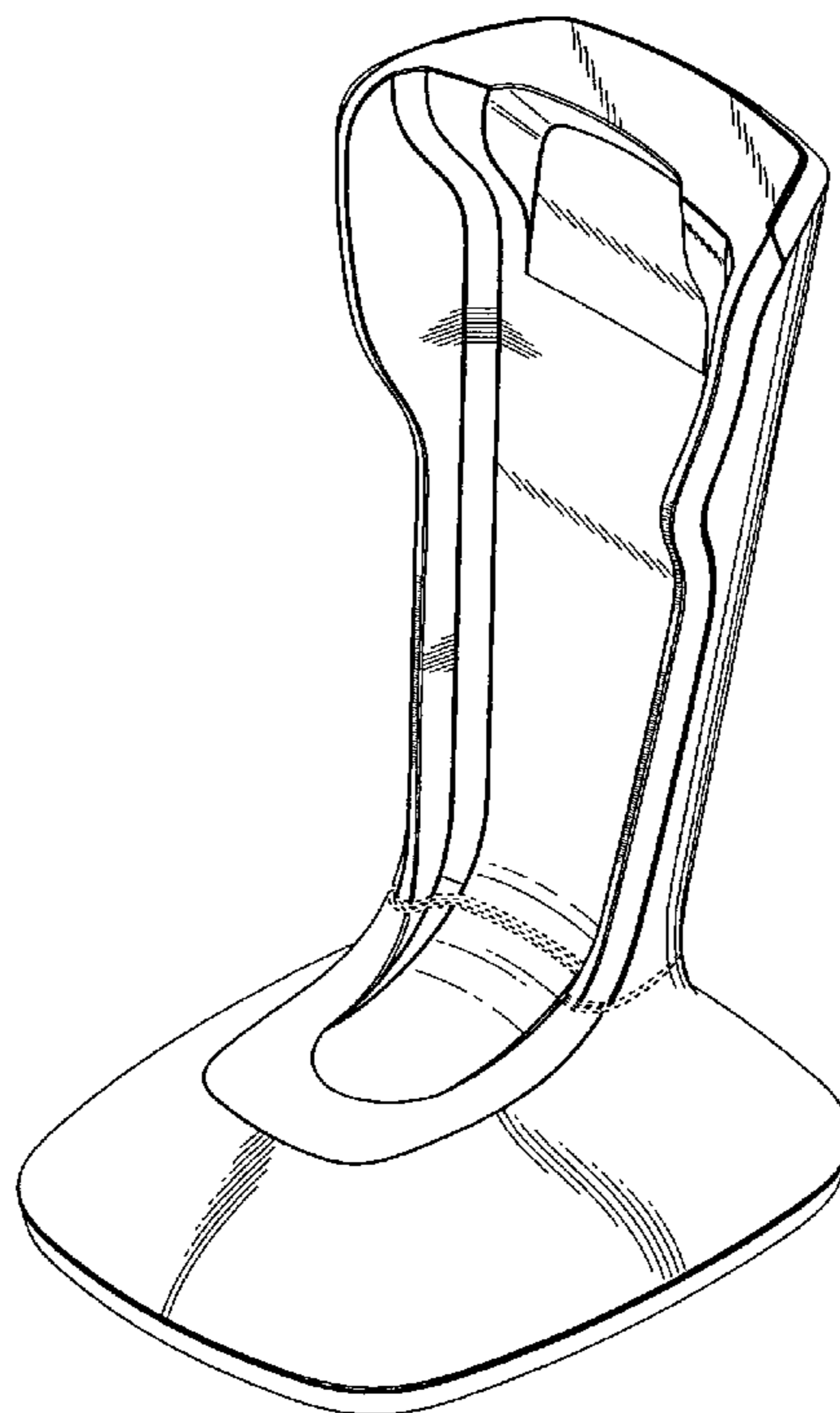

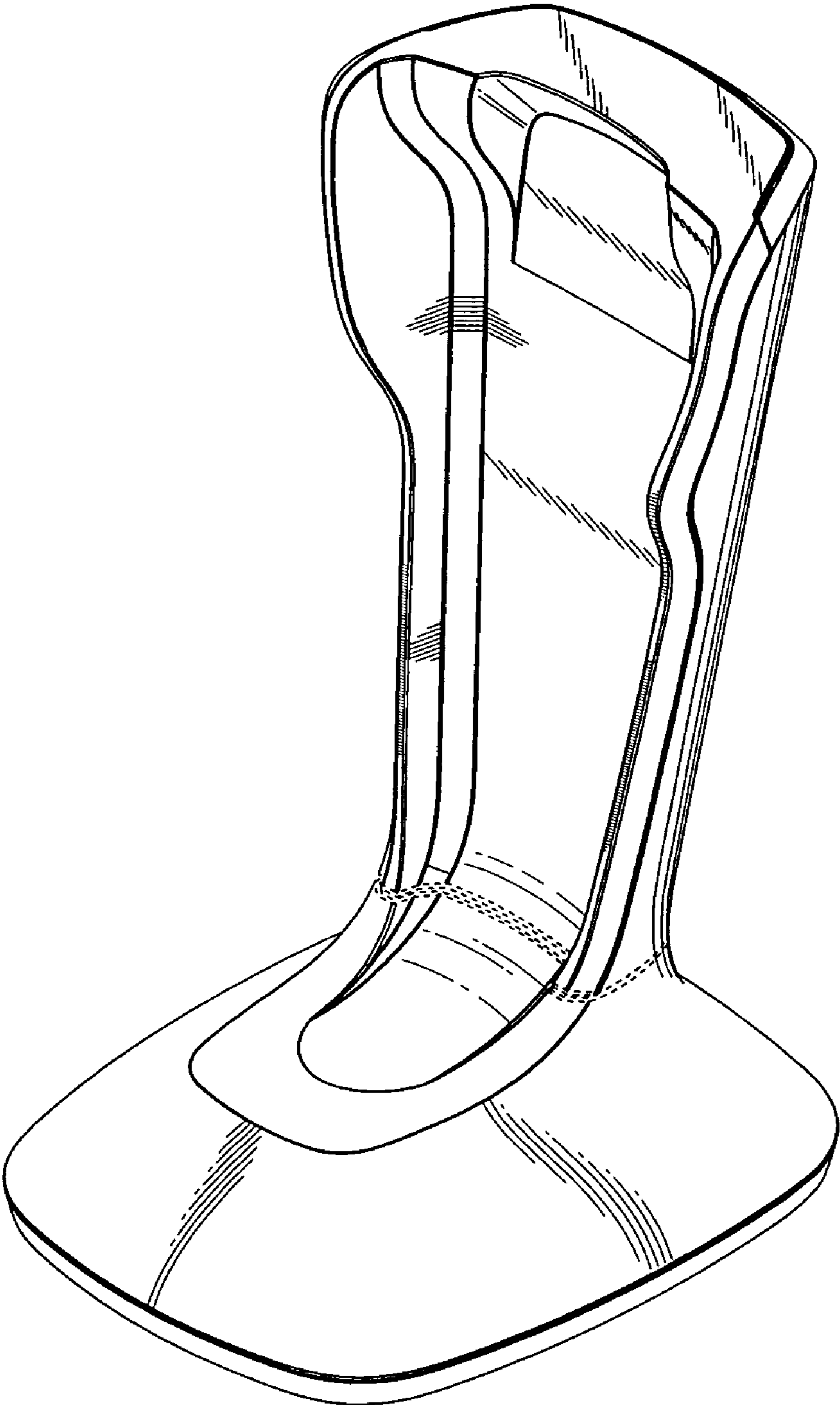

Fig. 1

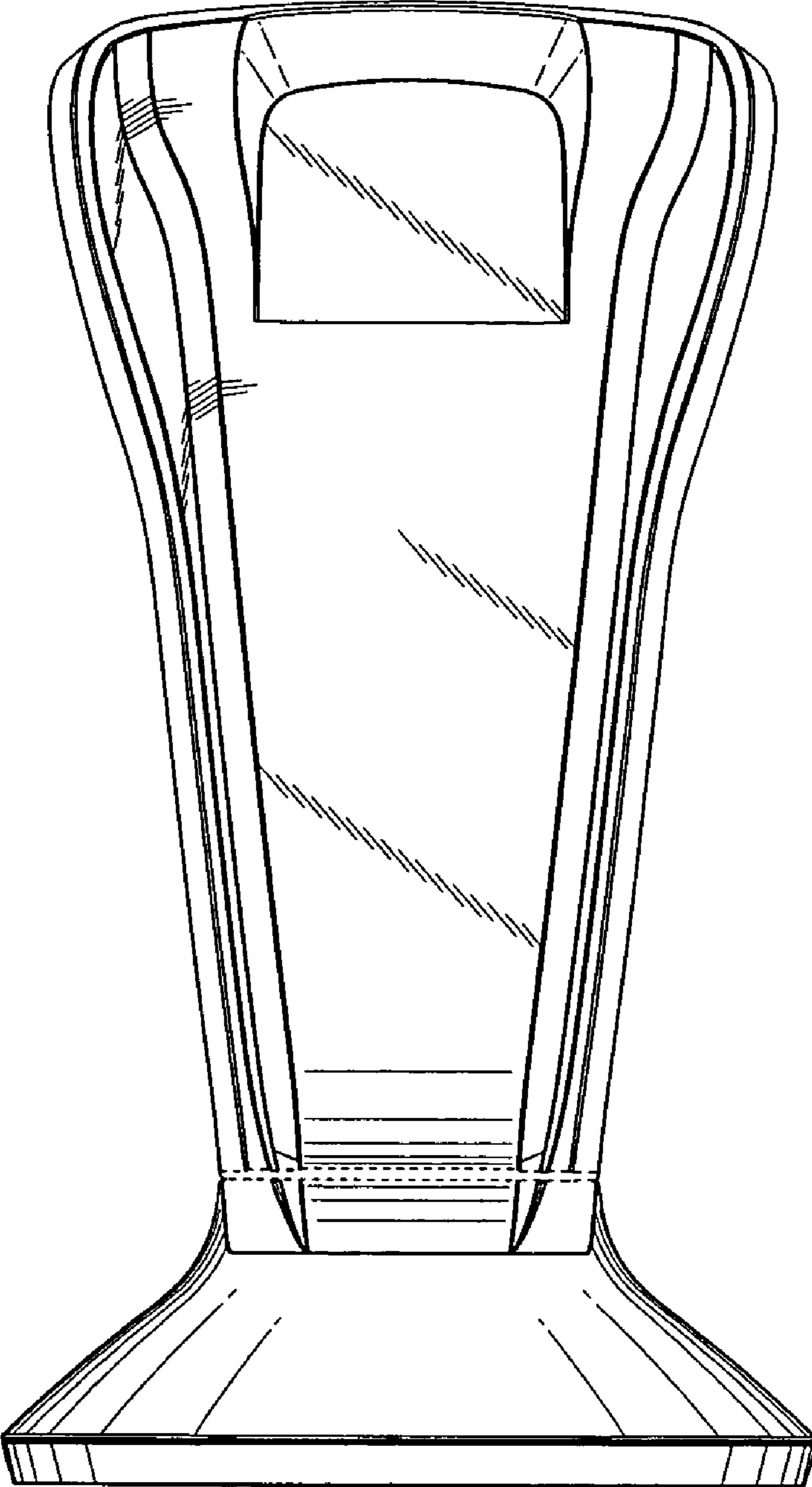

Fig. 2

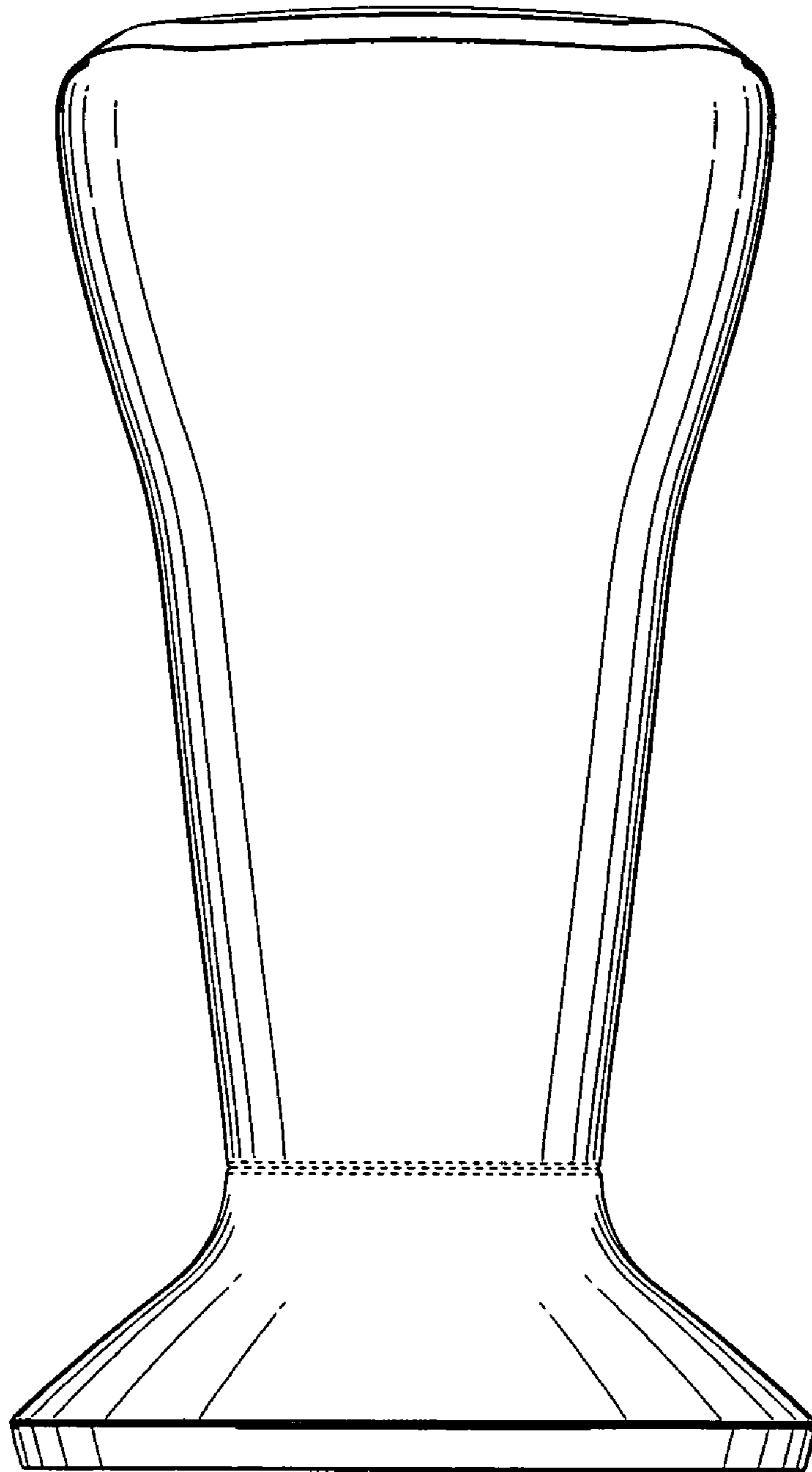

Fig. 3

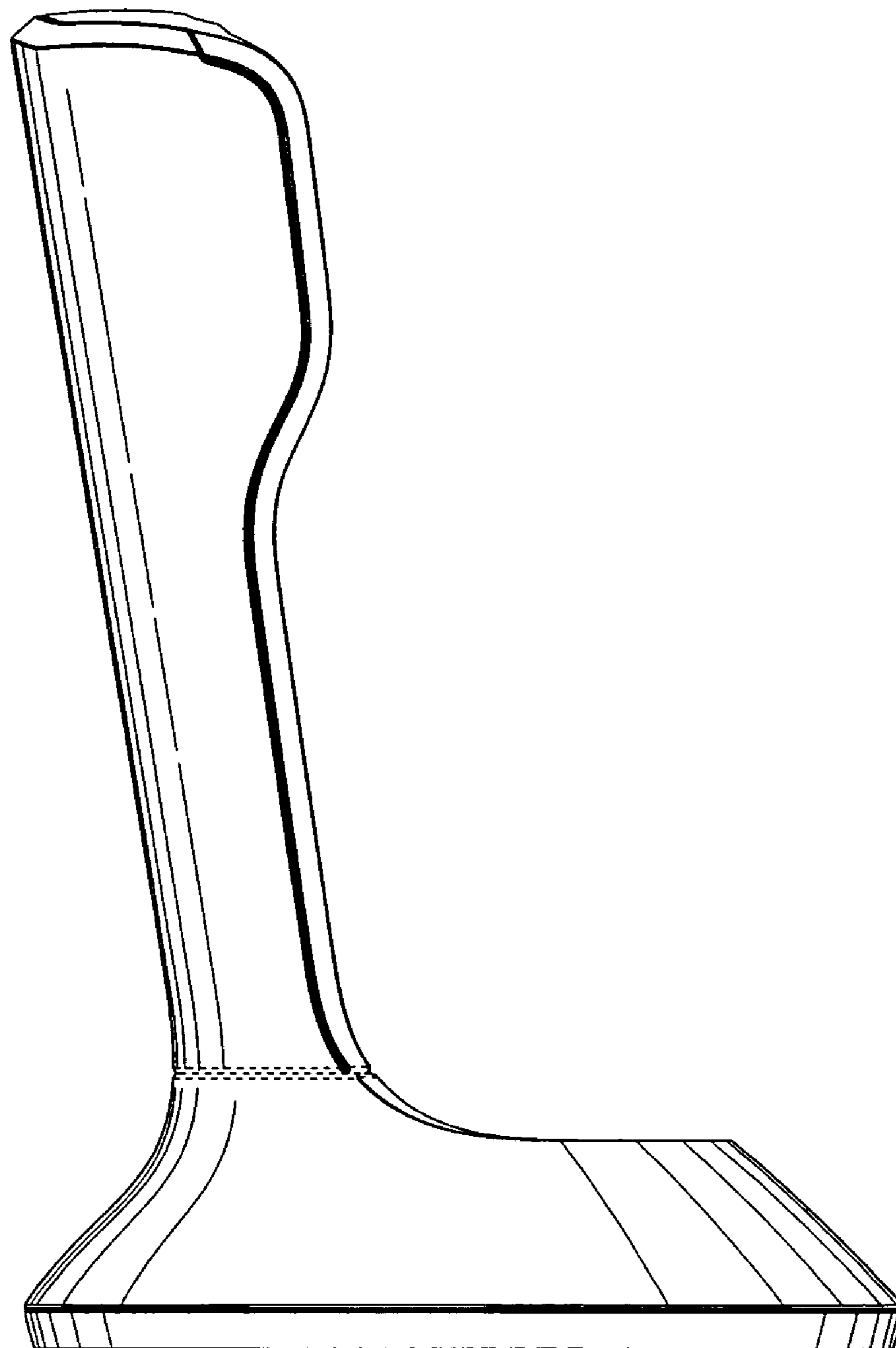

Fig. 4

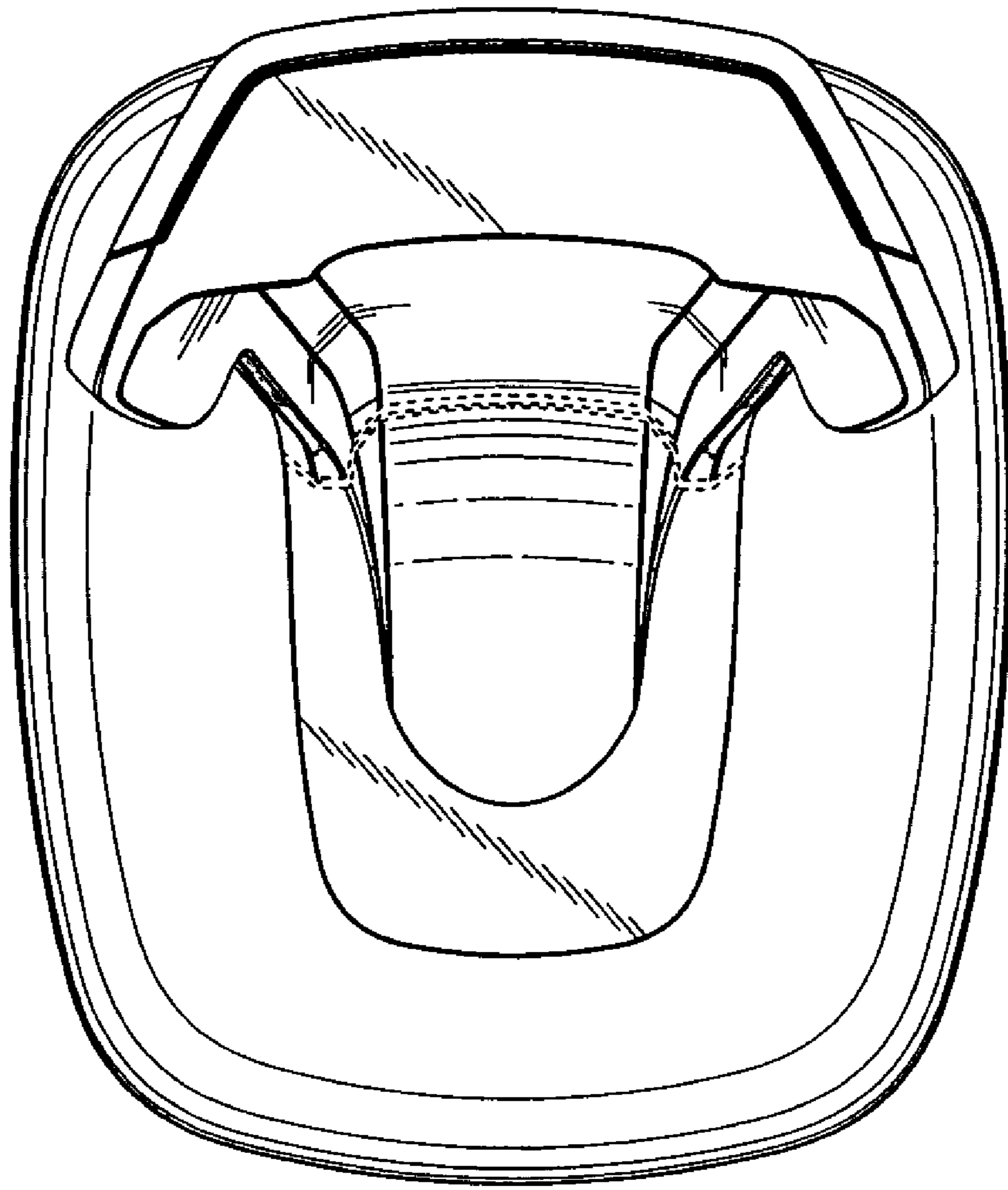

Fig. 5

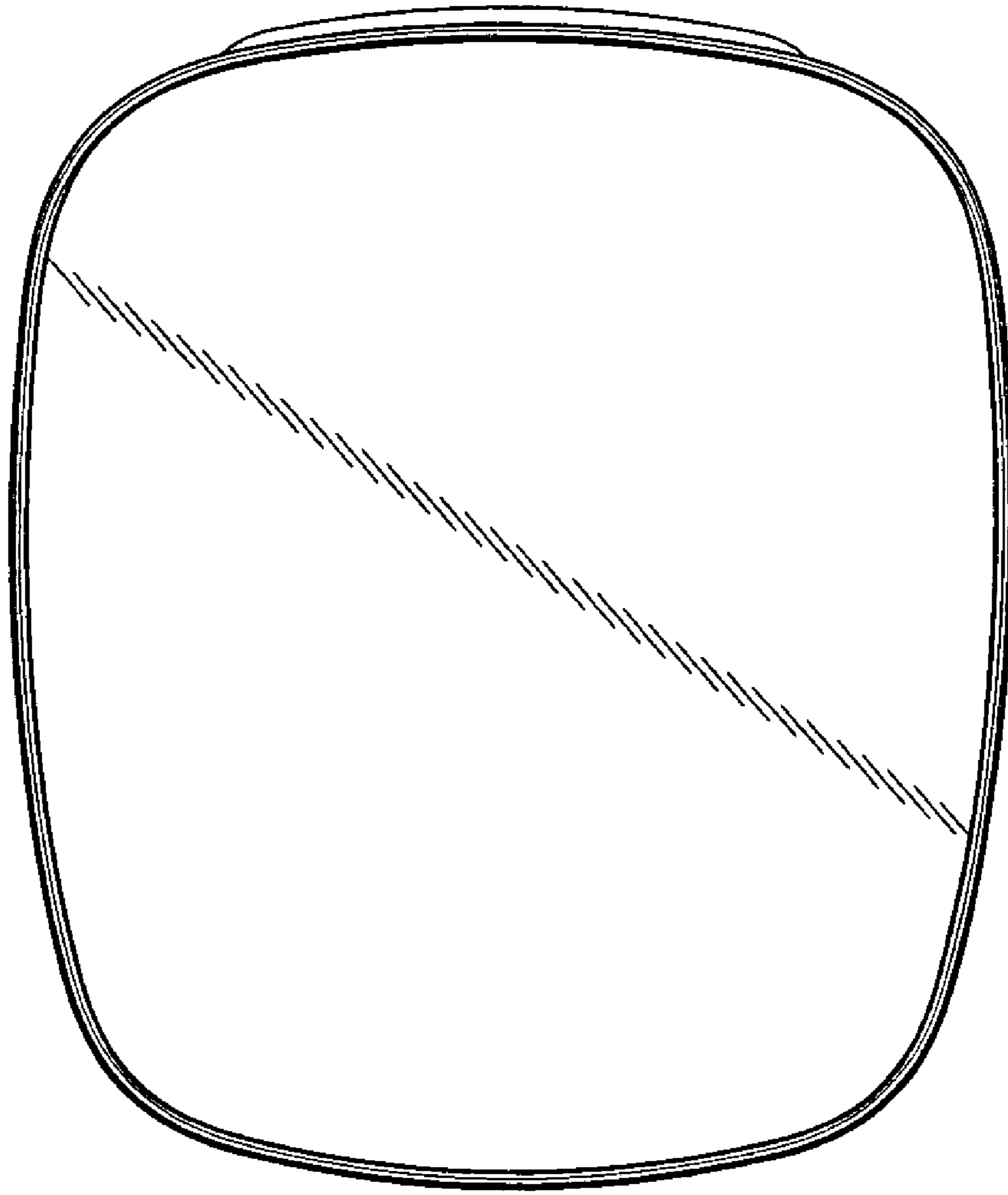

Fig. 6