



US00D559481S

(12) **United States Design Patent**  
**Renner**

(10) **Patent No.:** **US D559,481 S**  
(45) **Date of Patent:** **\*\* Jan. 8, 2008**

(54) **HIGH PRESSURE CLEANING APPARATUS**

(75) Inventor: **Reinhard Renner**, Esslingen (DE)

(73) Assignee: **Alfred Kaercher GmbH & Co. KG**, Winnenden (DE)

(\*\*) Term: **14 Years**

(21) Appl. No.: **29/271,496**

(22) Filed: **Jan. 18, 2007**

(30) **Foreign Application Priority Data**

Jul. 20, 2006 (EM) ..... 000563325

(51) **LOC (8) Cl.** ..... **15-05**

(52) **U.S. Cl.** ..... **D32/15**

(58) **Field of Classification Search** ..... D32/1,  
D32/15, 16, 25, 21, 22, 31; D15/7; 134/103.2,  
134/199, 200-201; 15/3, 320, 323, 332,  
15/403

See application file for complete search history.

(56) **References Cited**

**U.S. PATENT DOCUMENTS**

D481,838 S *	11/2003	Renner	.....	D32/15
D488,596 S *	4/2004	Cattaneo	.....	D32/15
D489,497 S *	5/2004	Cattaneo	.....	D32/15
D489,498 S *	5/2004	Cattaneo	.....	D32/15
D490,196 S *	5/2004	Lanfredi	.....	D32/15
D490,948 S *	6/2004	Cattaneo	.....	D32/15
D496,503 S *	9/2004	Chen	.....	D32/16
D528,714 S *	9/2006	Hong	.....	D32/15
D532,166 S *	11/2006	Reverberi	.....	D32/4

**OTHER PUBLICATIONS**

[http://www.karcher-usa.com/images/pressurewashers/500x500/k\\_225\\_500x550.jpg](http://www.karcher-usa.com/images/pressurewashers/500x500/k_225_500x550.jpg) Jul. 26, 2007.\*

Extract from catalog of Alfred Kaercher GmbH & Co. KG, "Catalogue 2001/2002", cover, pp. 7, 18, 19 and last page (Jun. 2001).

Extract from catalog of Alfred Kaercher GmbH & Co. KG, "Programme 2002", cover, pp. 7, 10, 38, 40 and last page (Feb. 2002).

Extract from catalog of Alfred Kaercher GmbH & Co. KG, "Programme 2003", cover, pp. 7, 10, 13, 14, 48 and last page (1Dec. 2002).

Extract from catalog of Alfred Kaercher GmbH & Co. KG, "Programme 2004", cover, pp. 5, 13, 15, 17, 21, 68, 73 and last page (Feb. 2004).

Extract from catalog of Alfred Kaercher GmbH & Co. KG, "Programme 2005", cover, pp. 8, 9, 10, 13, 15, 17, 69, 71, 72 and last page (Dec. 2004).

Extract from catalog of Alfred Kaercher GmbH & Co. KG, "Programme 2006", cover and pp. 8-9 (2006).

\* cited by examiner

*Primary Examiner*—Stella M. Reid

*Assistant Examiner*—Kathleen M. Sims

(74) *Attorney, Agent, or Firm*—Lipsitz & McAllister, LLC

(57) **CLAIM**

The ornamental design for a high pressure cleaning apparatus, as shown and described.

**DESCRIPTION**

FIG. 1 is a front and right side perspective view of the high pressure cleaning apparatus showing my new design;

FIG. 2 is a front and left side perspective view of the design;

FIG. 3 is a front elevational view of the design;

FIG. 4 is a right side elevational view of the design;

FIG. 5 is a rear elevational view of the design;

FIG. 6 is left side elevational view of the design;

FIG. 7 is a top plan view of the design; and,

FIG. 8 is a bottom plan view of the design.

**1 Claim, 8 Drawing Sheets**

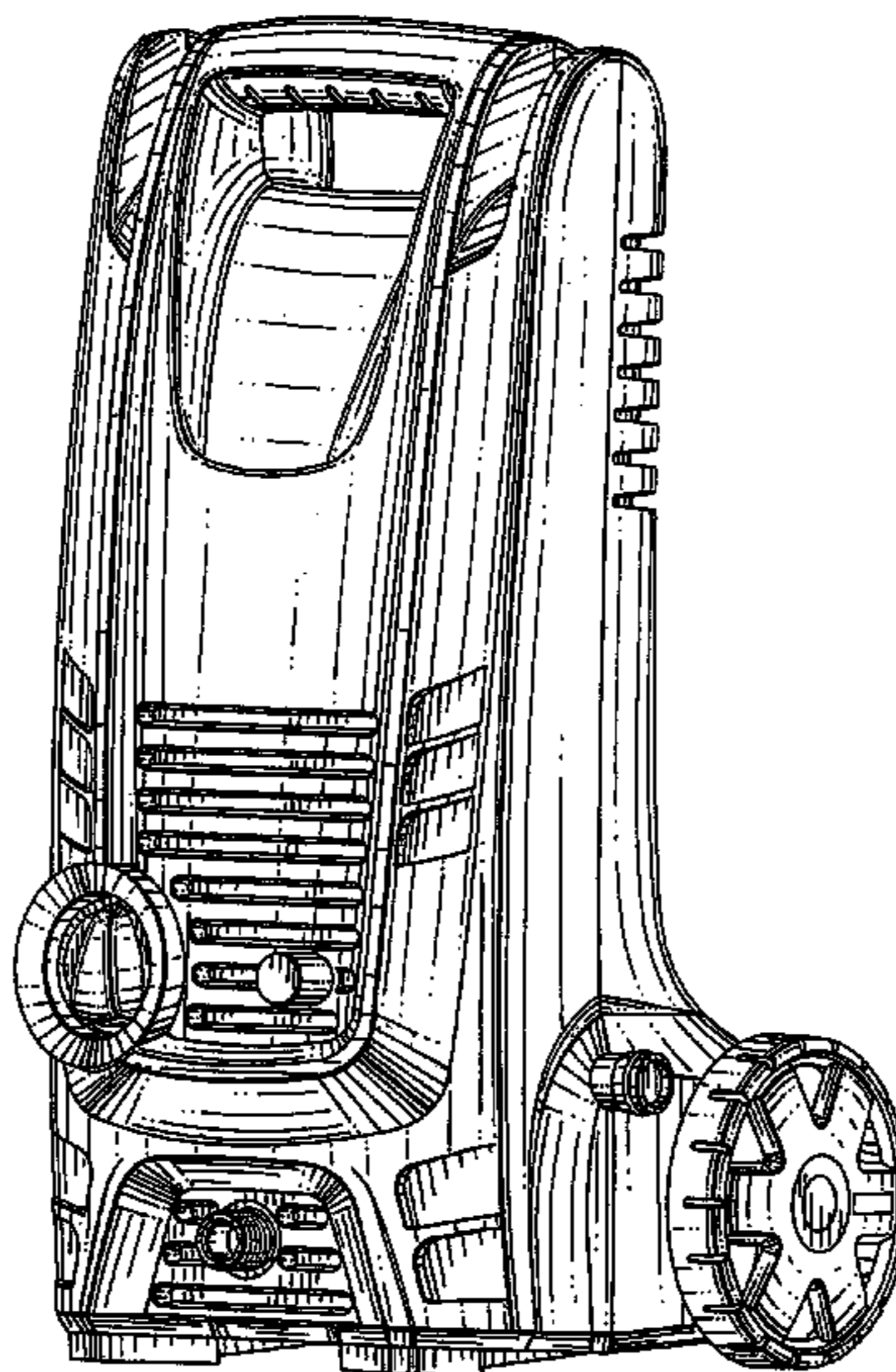

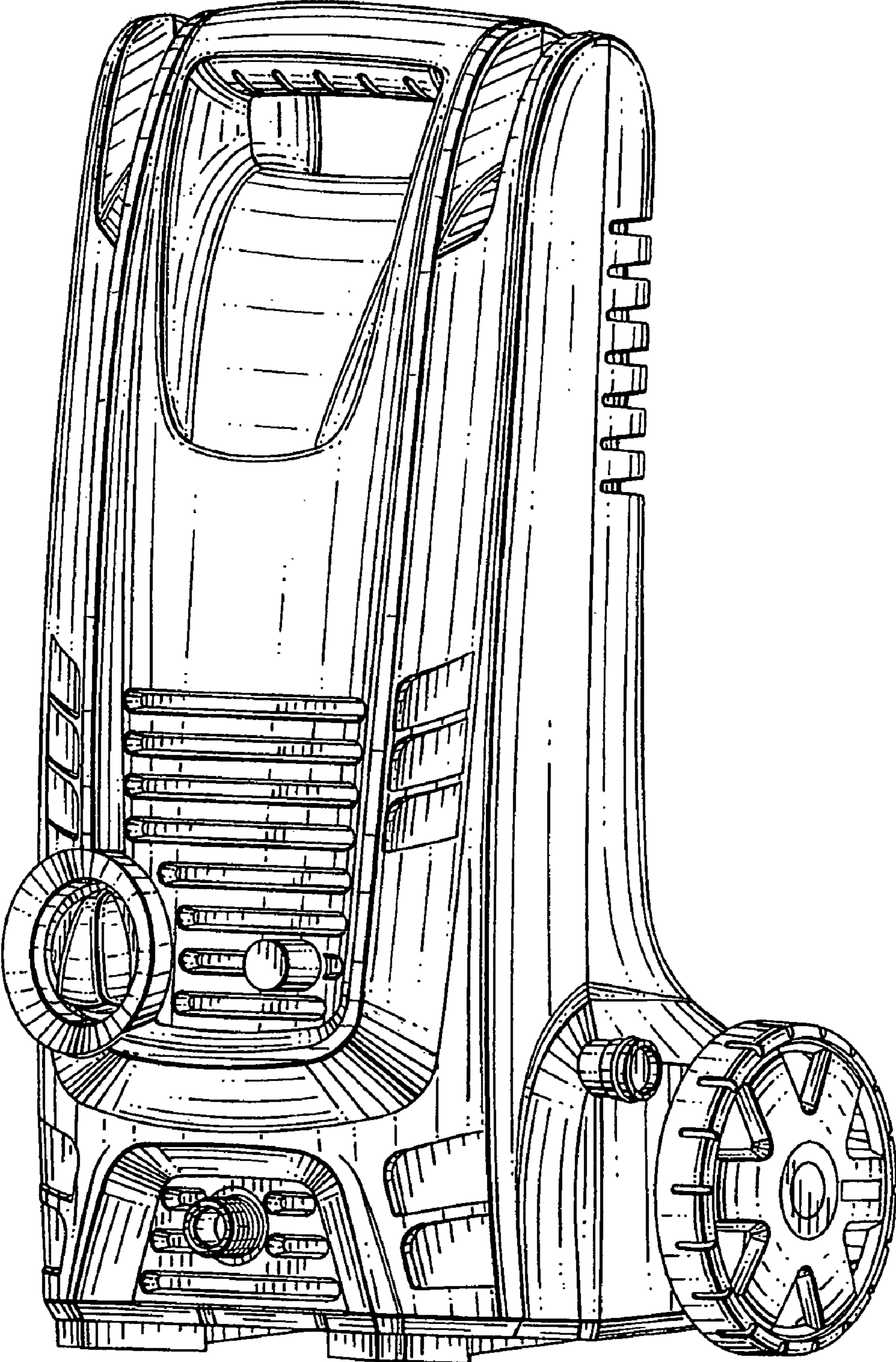

FIG. 1

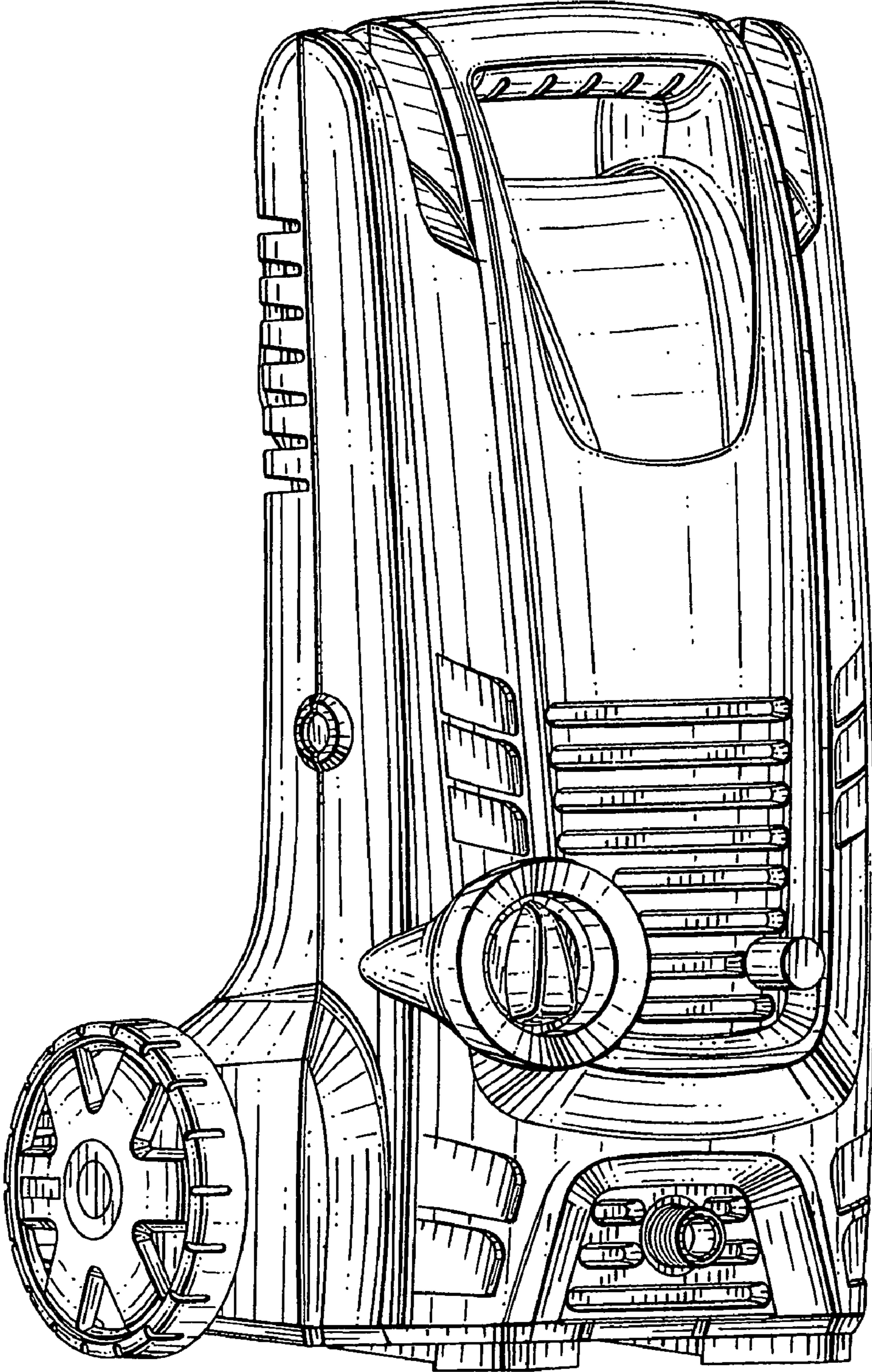

FIG.2

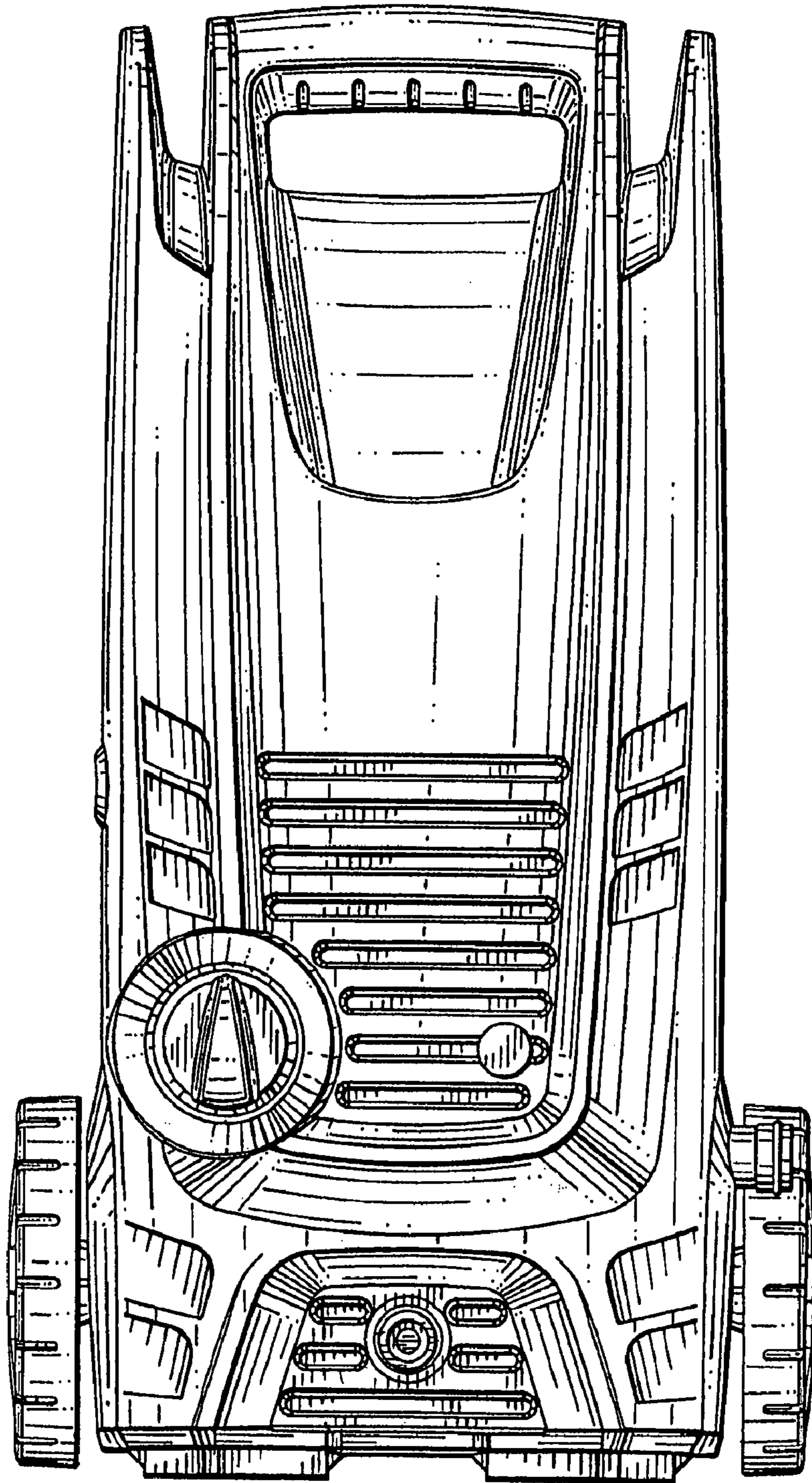

FIG.3

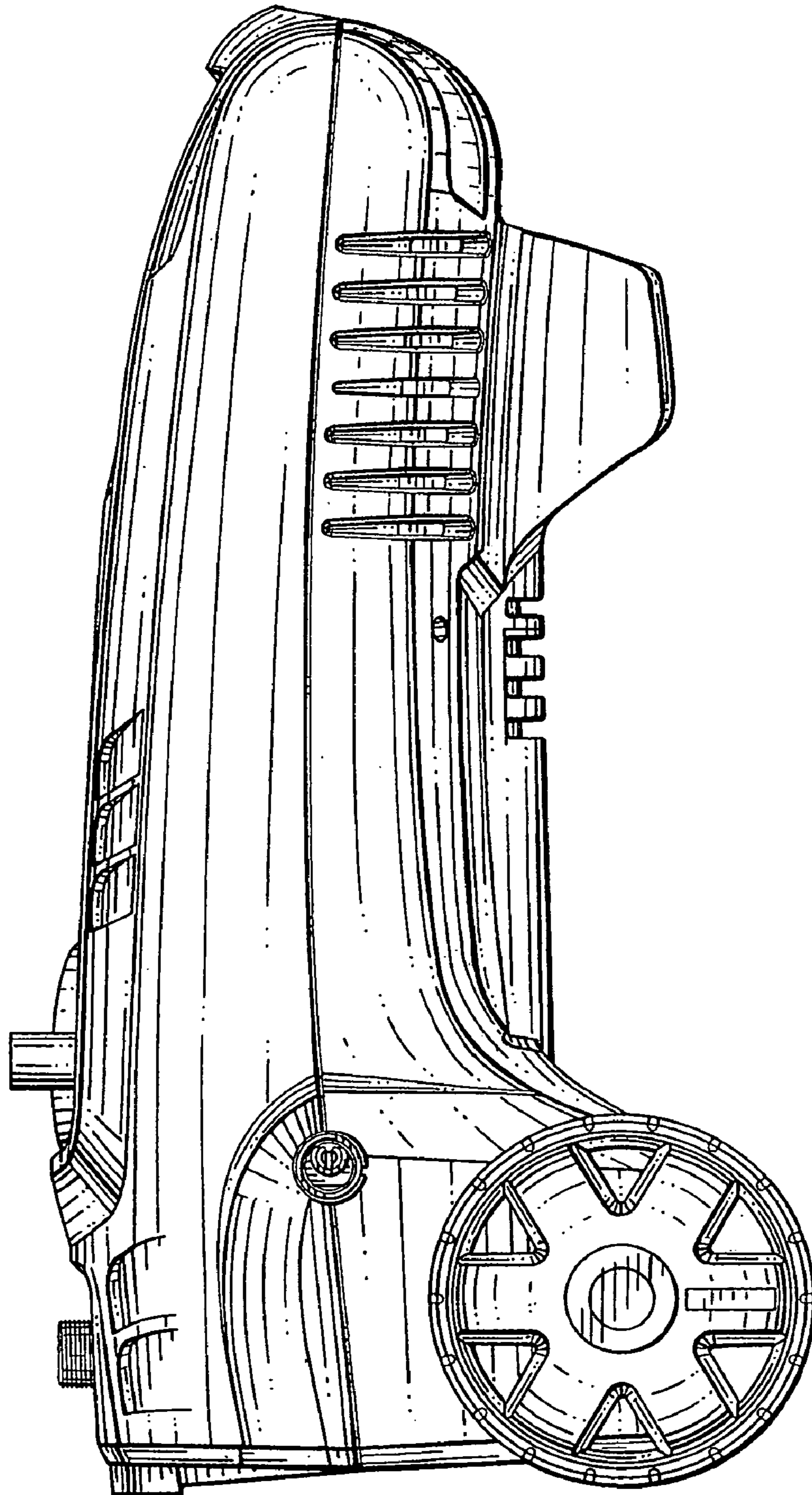

FIG. 4

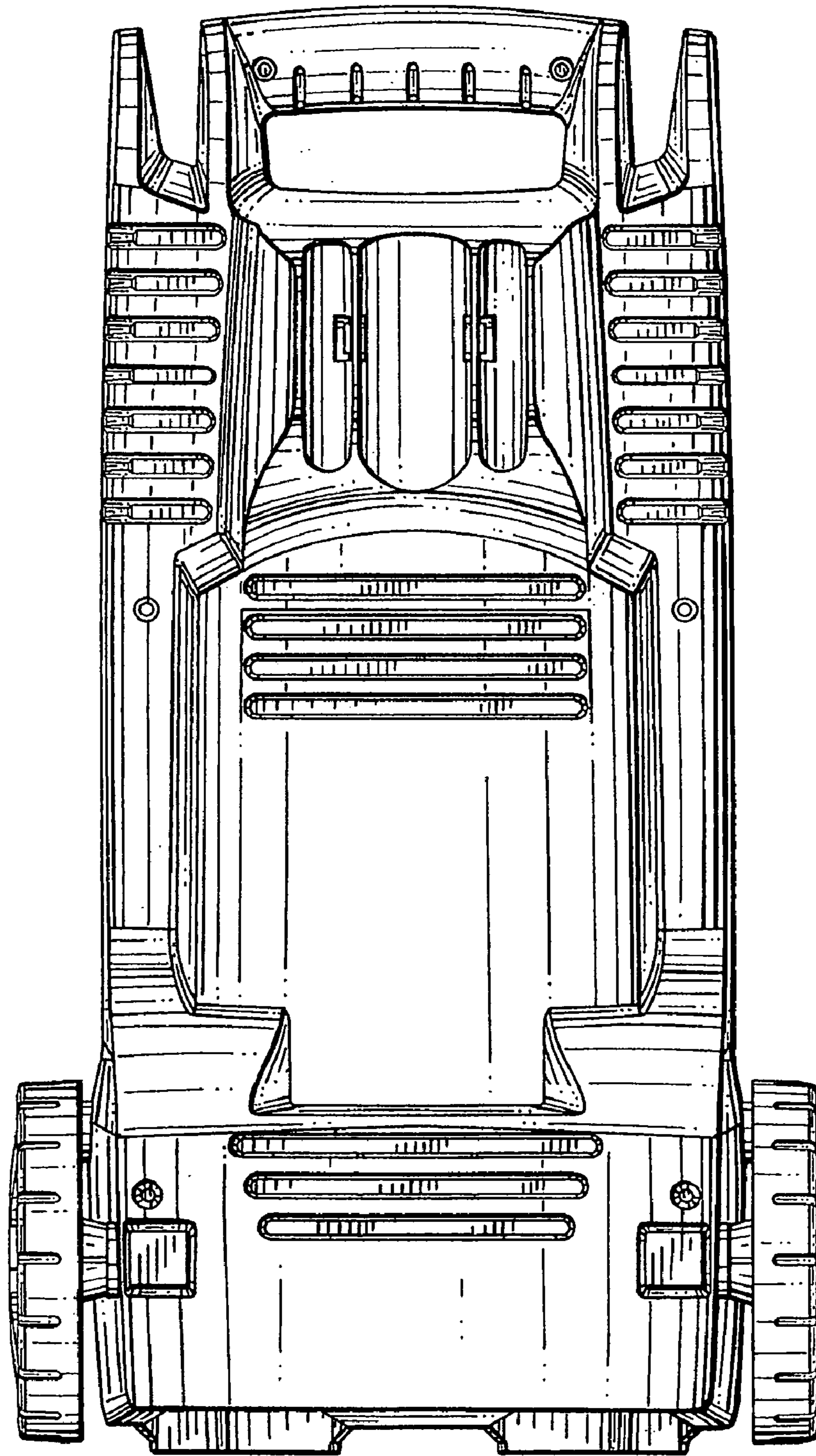

FIG. 5

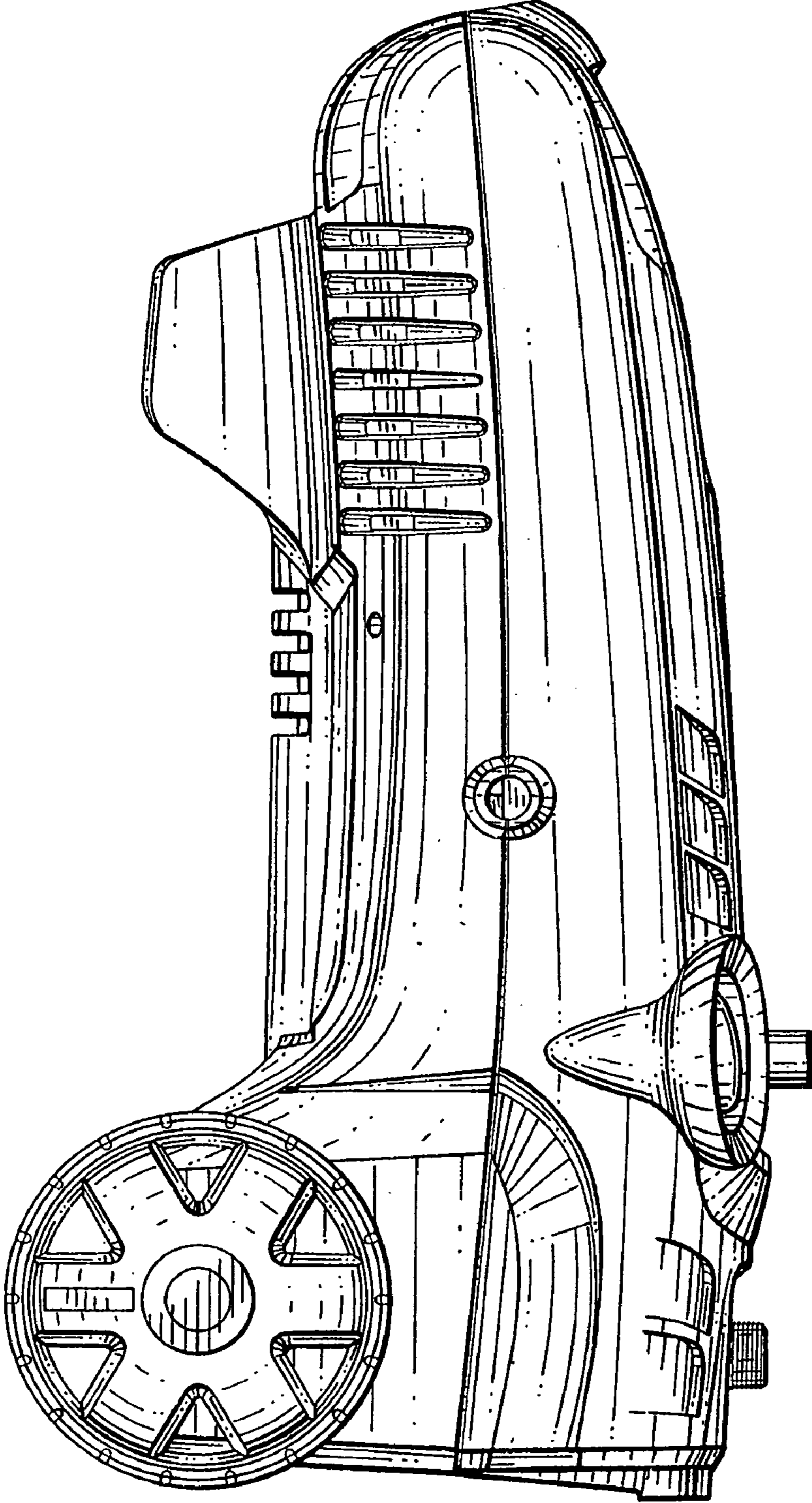

FIG. 6

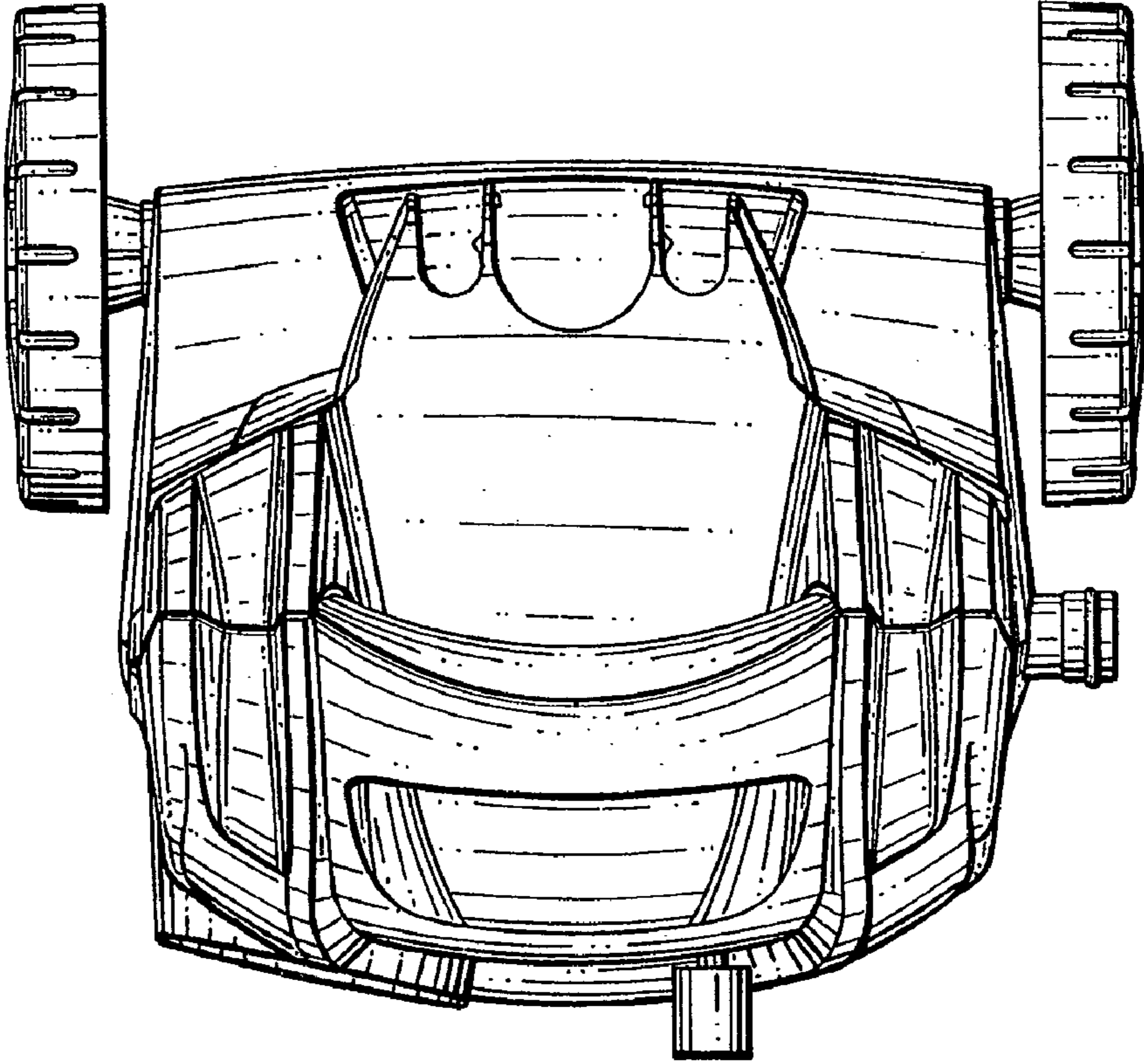

FIG. 7



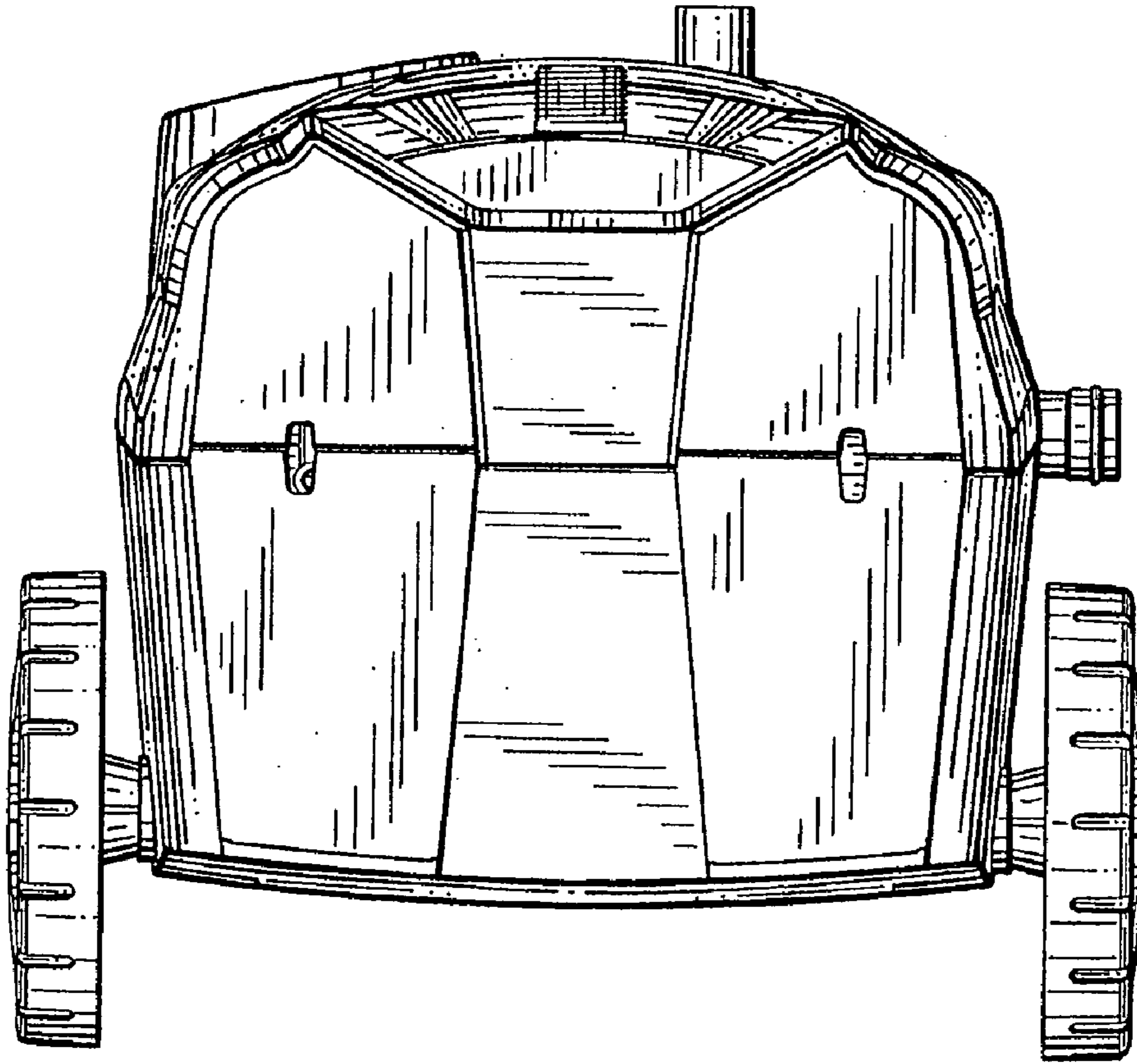

FIG. 8