



US00D559403S

(12) **United States Design Patent**
Vils

(10) **Patent No.:** **US D559,403 S**
(45) **Date of Patent:** **** Jan. 8, 2008**

(54) **LIVING MODULE**

(76) Inventor: **Andreas Vils**, Via Daitg, CH-7402
Rhäzüns (CH)

(**) Term: **14 Years**

(21) Appl. No.: **29/278,307**

(22) Filed: **Mar. 26, 2007**

(30) **Foreign Application Priority Data**

Sep. 25, 2006 (CH) 133260

(51) **LOC (8) Cl.** **25-01**

(52) **U.S. Cl.** **D25/3; D25/33**

(58) **Field of Classification Search** D25/1,
D25/3, 33; D12/101-104; 52/79.1, 79.4,
52/652.1, DIG. 10

See application file for complete search history.

(56) **References Cited**

U.S. PATENT DOCUMENTS

2,886,856	A *	5/1959	Che	52/69
D193,549	S *	9/1962	Ziparsky	D12/104
D223,441	S *	4/1972	Holt	D25/33
4,343,117	A *	8/1982	Shemitz	52/91.1
5,656,491	A *	8/1997	Cassani et al.	435/283.1
5,904,005	A *	5/1999	Dyer et al.	52/71
2005/0066588	A1 *	3/2005	Stapleton et al.	52/79.1
2005/0066589	A1 *	3/2005	Bedell et al.	52/79.1
2005/0262778	A1 *	12/2005	Allen et al.	52/79.1

2006/0059792 A1* 3/2006 Tiramani 52/79.1
2006/0168901 A1* 8/2006 Window 52/79.1

* cited by examiner

Primary Examiner—Stella M. Reid
Assistant Examiner—Eric L. Goodman
(74) *Attorney, Agent, or Firm*—Adam J. Cermak; Cermak,
Kenealy & Vaidya LLP

(57) **CLAIM**

The ornamental design for a living module, as shown and described.

DESCRIPTION

FIG. 1 is a top, left, front perspective view of a living module showing my new design;

FIG. 2 is a top, left, rear perspective view of a living module showing my new design;

FIG. 3 is a right side elevational view of the living module shown in FIG. 1;

FIG. 4 is a front elevational view of the living module shown in FIG. 1;

FIG. 5 is a left side elevational view of the living module shown in FIG. 1; and,

FIG. 6 is a rear elevational view of the living module shown in FIG. 1.

The bottom is flat and devoid of surface ornamentation.

1 Claim, 3 Drawing Sheets

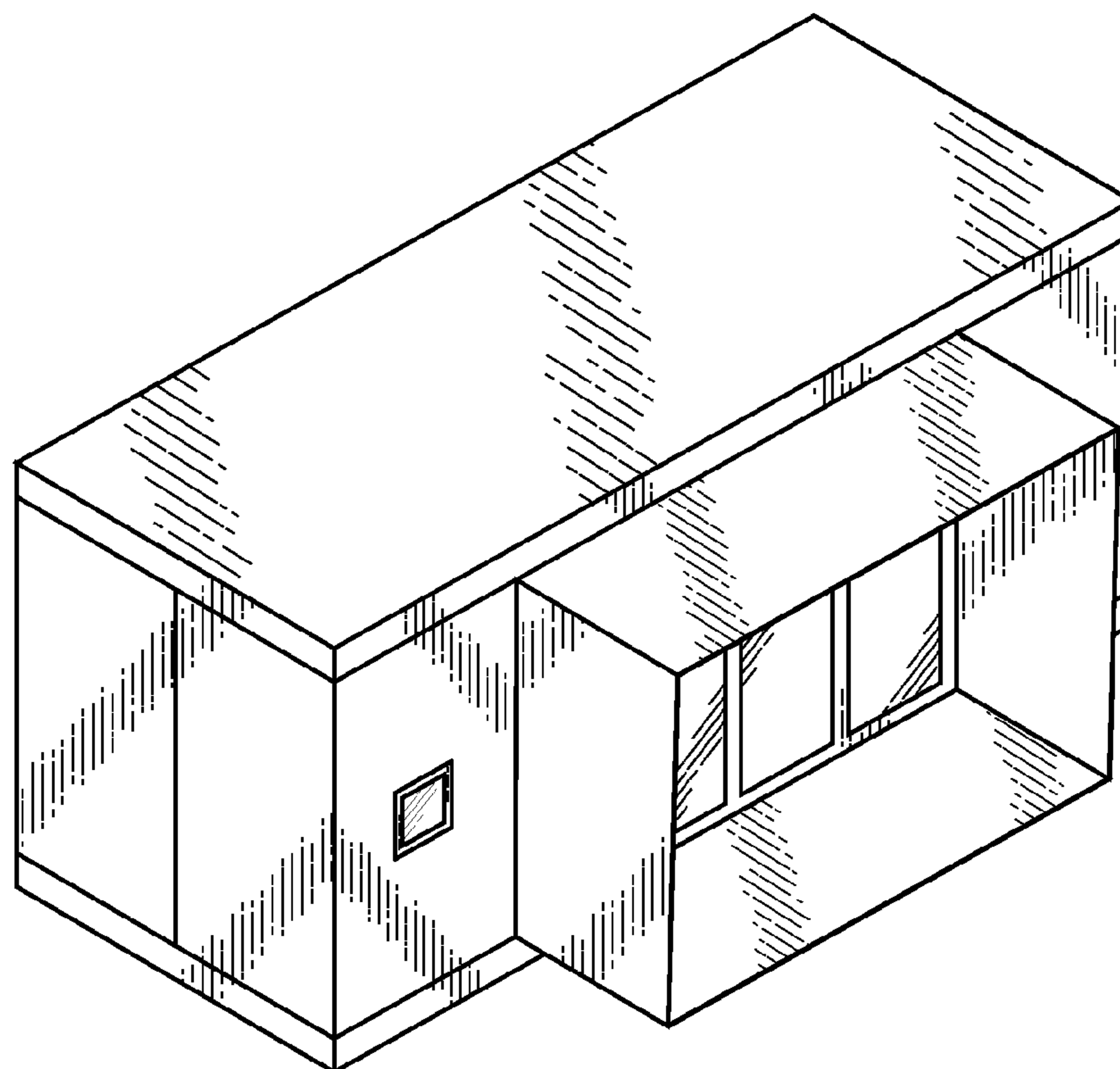

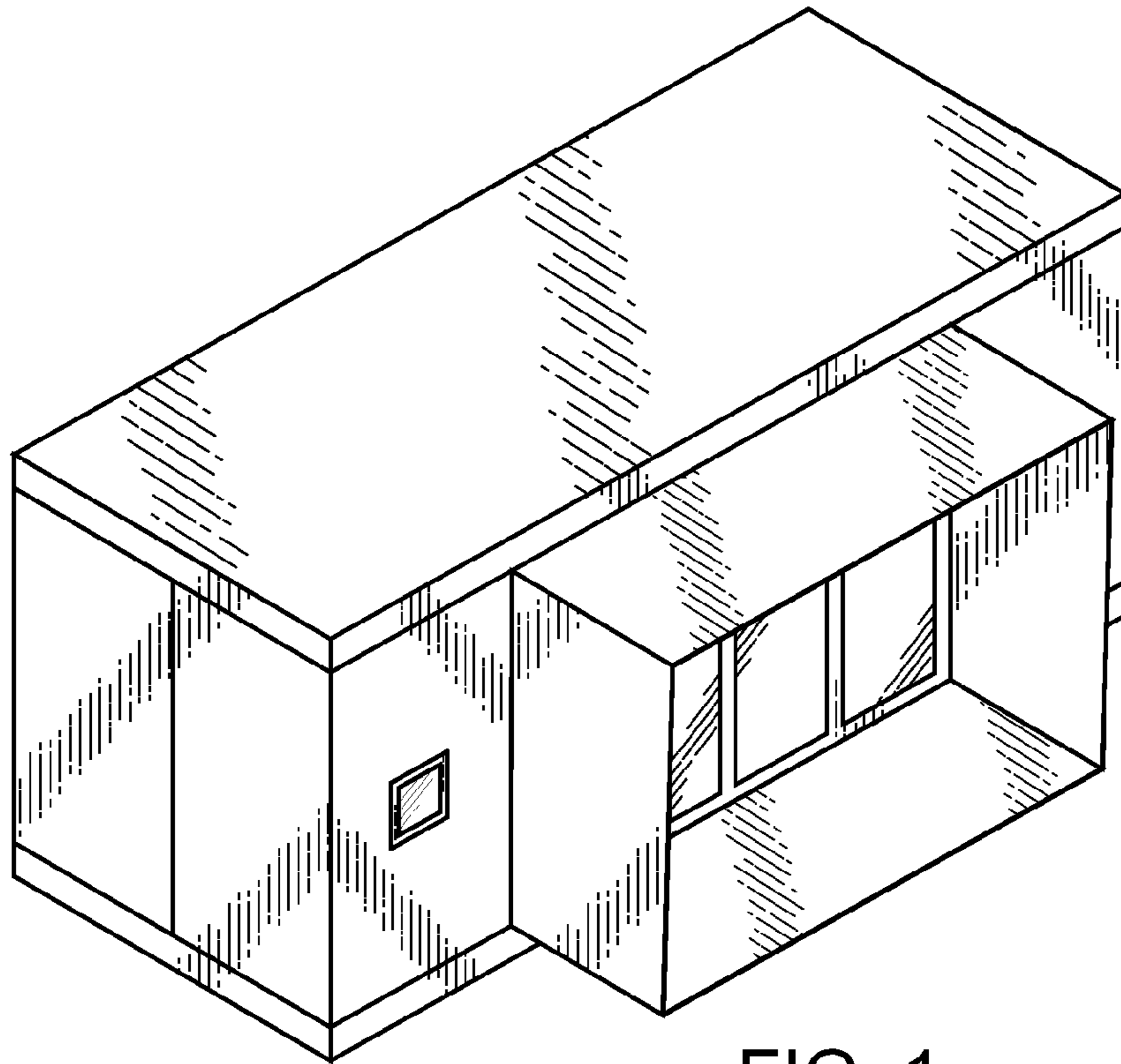

FIG. 1

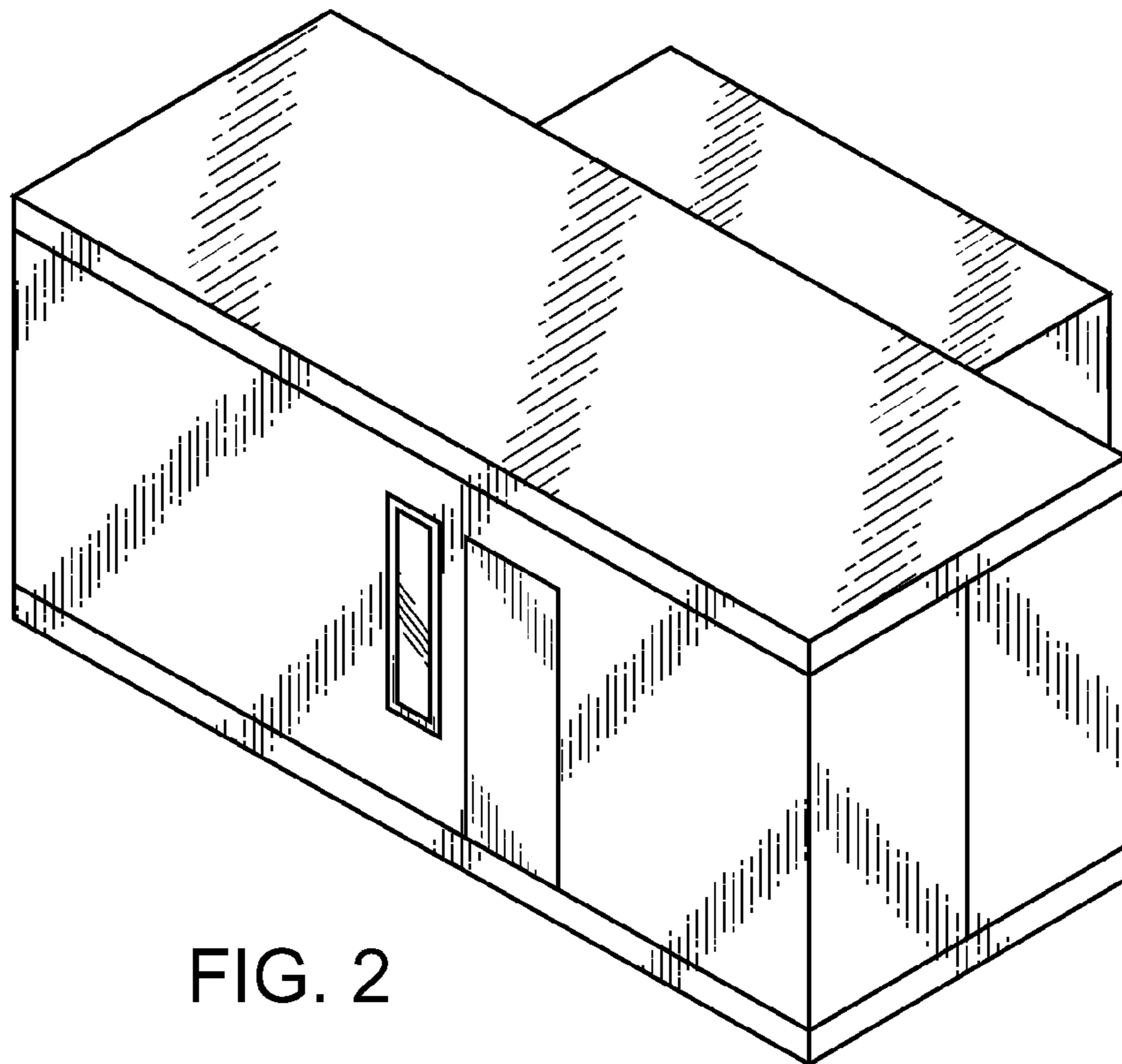

FIG. 2

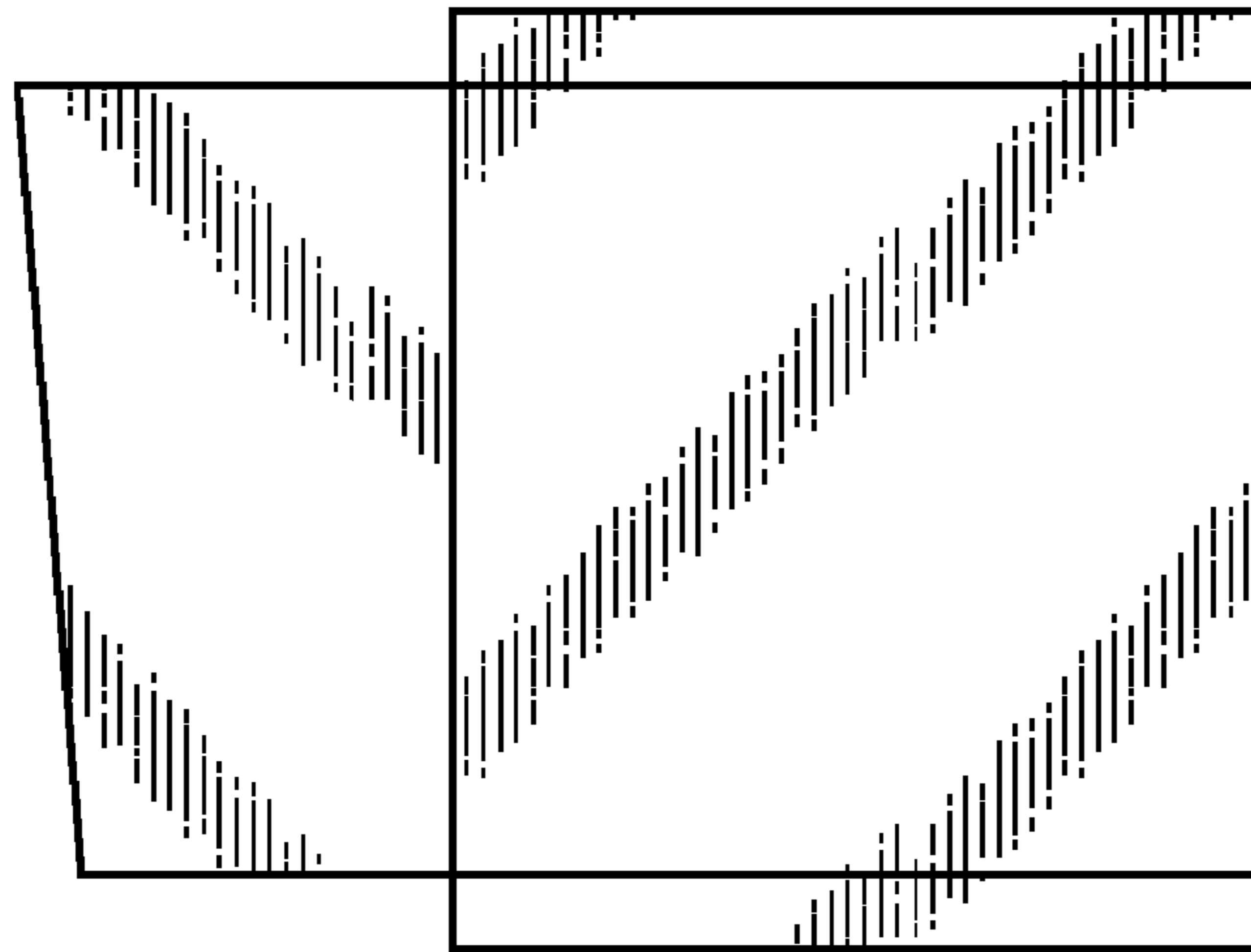

FIG. 3

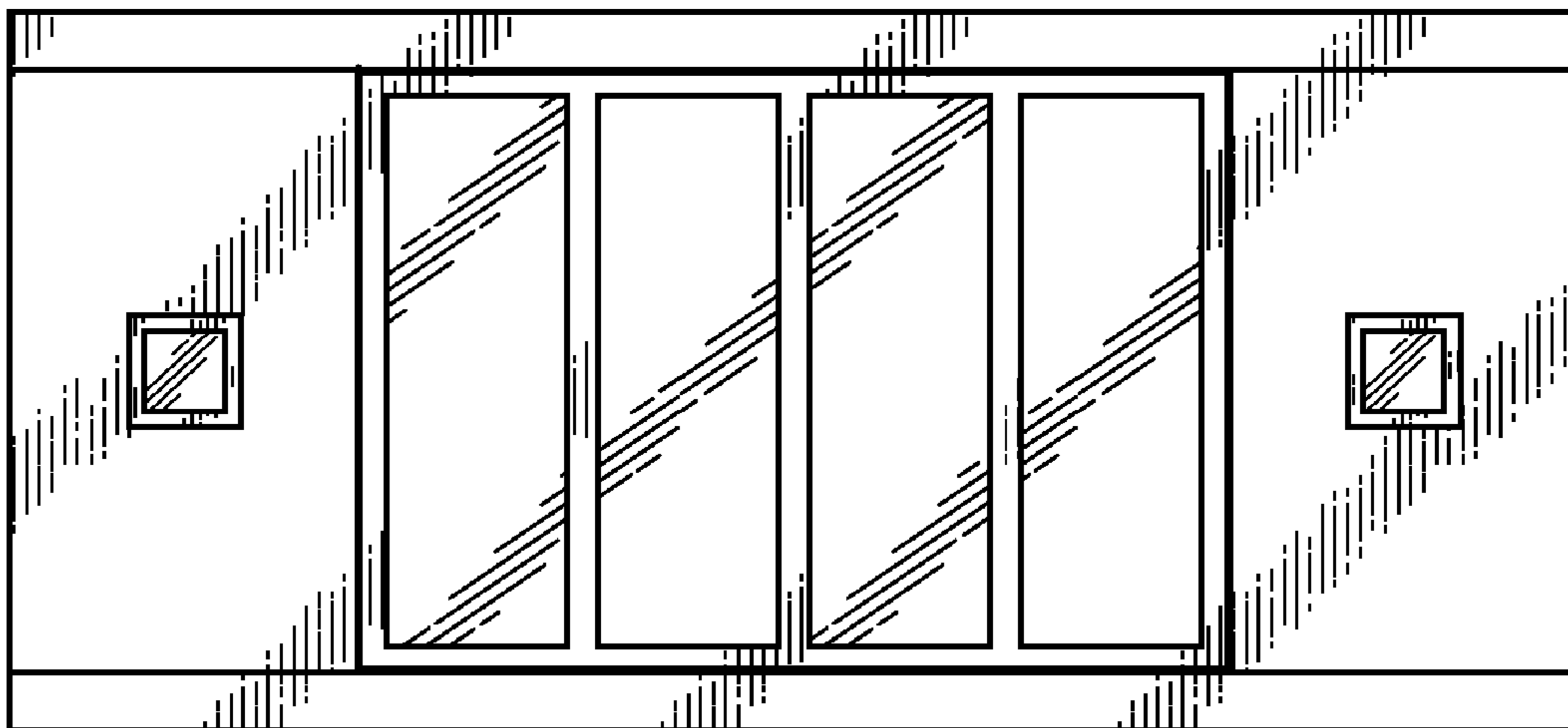

FIG. 4

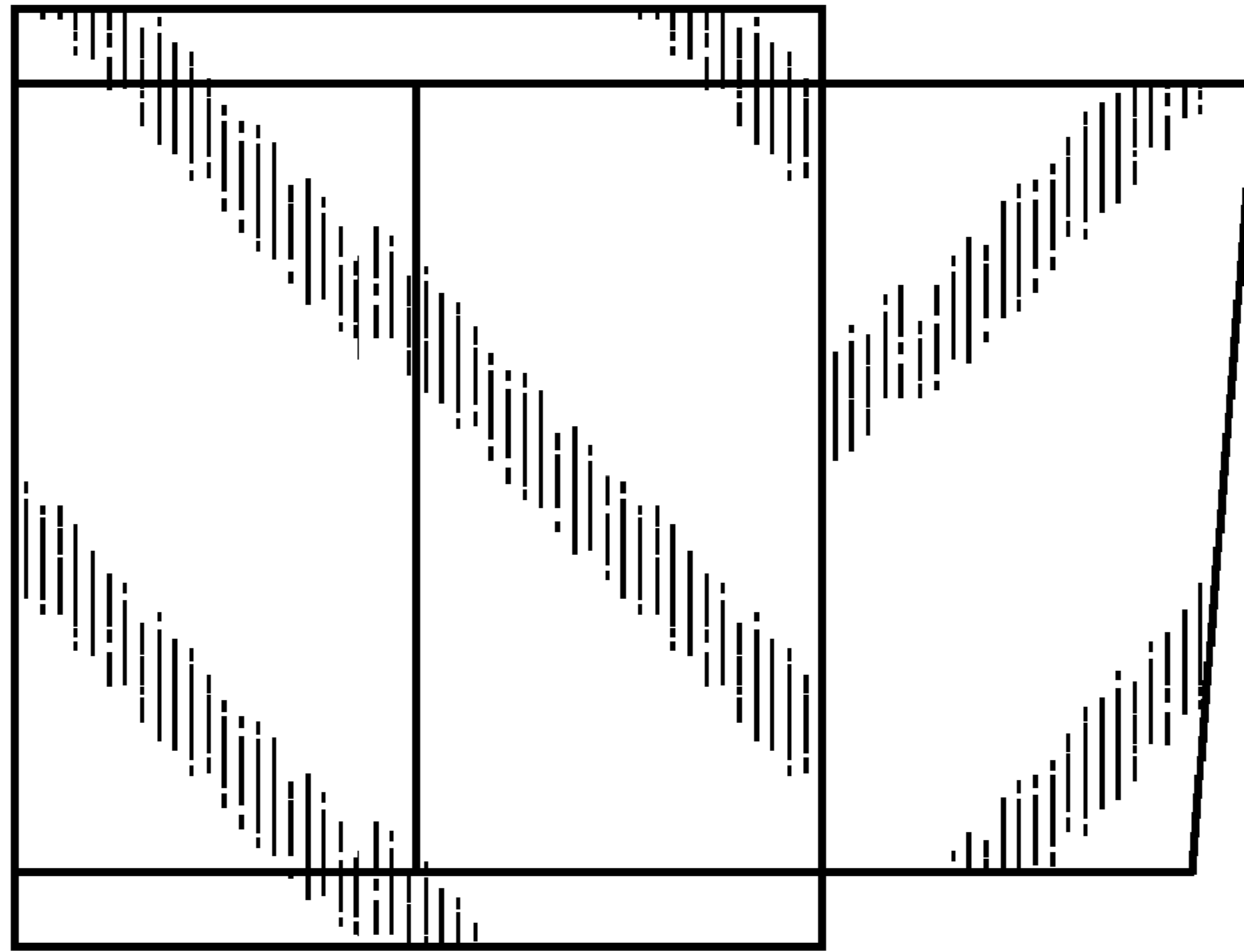

FIG. 5

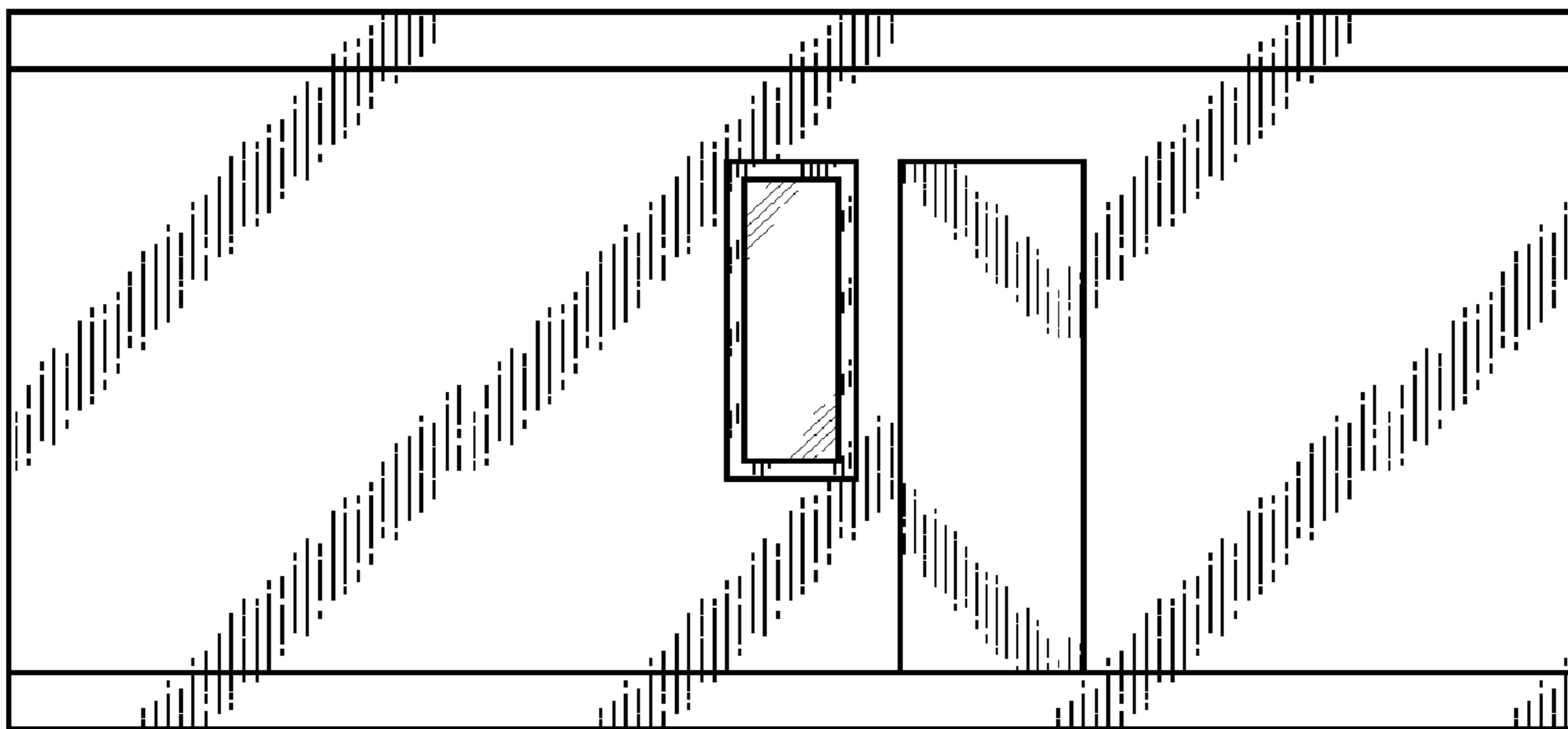

FIG. 6