



US00D559391S

(12) **United States Design Patent**
Kliegman et al.

(10) **Patent No.:** **US D559,391 S**

(45) **Date of Patent:** **** Jan. 8, 2008**

(54) **PACIFIER**

(75) Inventors: **Adriana Kliegman**, New York, NY
(US); **Diana B. Sierra**, Hackensack, NJ
(US)

(73) Assignee: **Playtex Products, Inc.**, Westport, CT
(US)

(**) Term: **14 Years**

(21) Appl. No.: **29/272,632**

(22) Filed: **Feb. 13, 2007**

Related U.S. Application Data

(62) Division of application No. 29/259,285, filed on May 5, 2006.

(51) **LOC (8) Cl.** **24-04**

(52) **U.S. Cl.** **D24/194**

(58) **Field of Classification Search** D24/193-199,
D24/215; 606/234-236; 24/301; 215/11.1-11.6,
215/387, 392; 248/102-107
See application file for complete search history.

(56) **References Cited**

U.S. PATENT DOCUMENTS

3,267,937 A	8/1966	Verschoor	606/236
D267,116 S	11/1982	Bobelis et al.	D24/194
D303,839 S	10/1989	Fitzpatrick et al.	D24/194
D326,919 S	6/1992	Geitner et al.	D24/194
D334,064 S	3/1993	Fitzpatrick	D24/194
D340,525 S *	10/1993	Rohrig	D24/194
D380,836 S *	7/1997	Fitzpatrick et al.	D24/194
D391,641 S *	3/1998	Fields et al.	D24/194

D393,074 S *	3/1998	Fields et al.	D24/194
D404,137 S	1/1999	Underwood et al.	D24/194
D413,387 S *	8/1999	Fitzpatrick et al.	D24/194
D414,267 S	9/1999	Calandro	D24/194
D450,126 S	11/2001	Fitzpatrick et al.	D24/194
6,695,869 B2	2/2004	Fitzpatrick et al.	606/234
D532,521 S *	11/2006	Struckmeier	D24/194
D532,522 S *	11/2006	Struckmeier	D24/194
2001/0047189 A1 *	11/2001	Griffith	606/234
2003/0100922 A1 *	5/2003	Fitzpatrick et al.	606/234

* cited by examiner

Primary Examiner—Stella M. Reid

Assistant Examiner—Susan E Krakower

(74) *Attorney, Agent, or Firm*—Ohlandt, Greeley, Ruggiero & Perle, L.L.P.

(57) **CLAIM**

The ornamental design for a pacifier, as shown and described.

DESCRIPTION

FIG. 1 is a front perspective view of a pacifier showing my design;

FIG. 2 is a rear perspective view thereof;

FIG. 3 is a front view thereof;

FIG. 4 is a rear view thereof;

FIG. 5 is a side view thereof, the opposite side being identical;

FIG. 6 is a top view thereof; and,

FIG. 7 is a bottom view thereof.

1 Claim, 3 Drawing Sheets

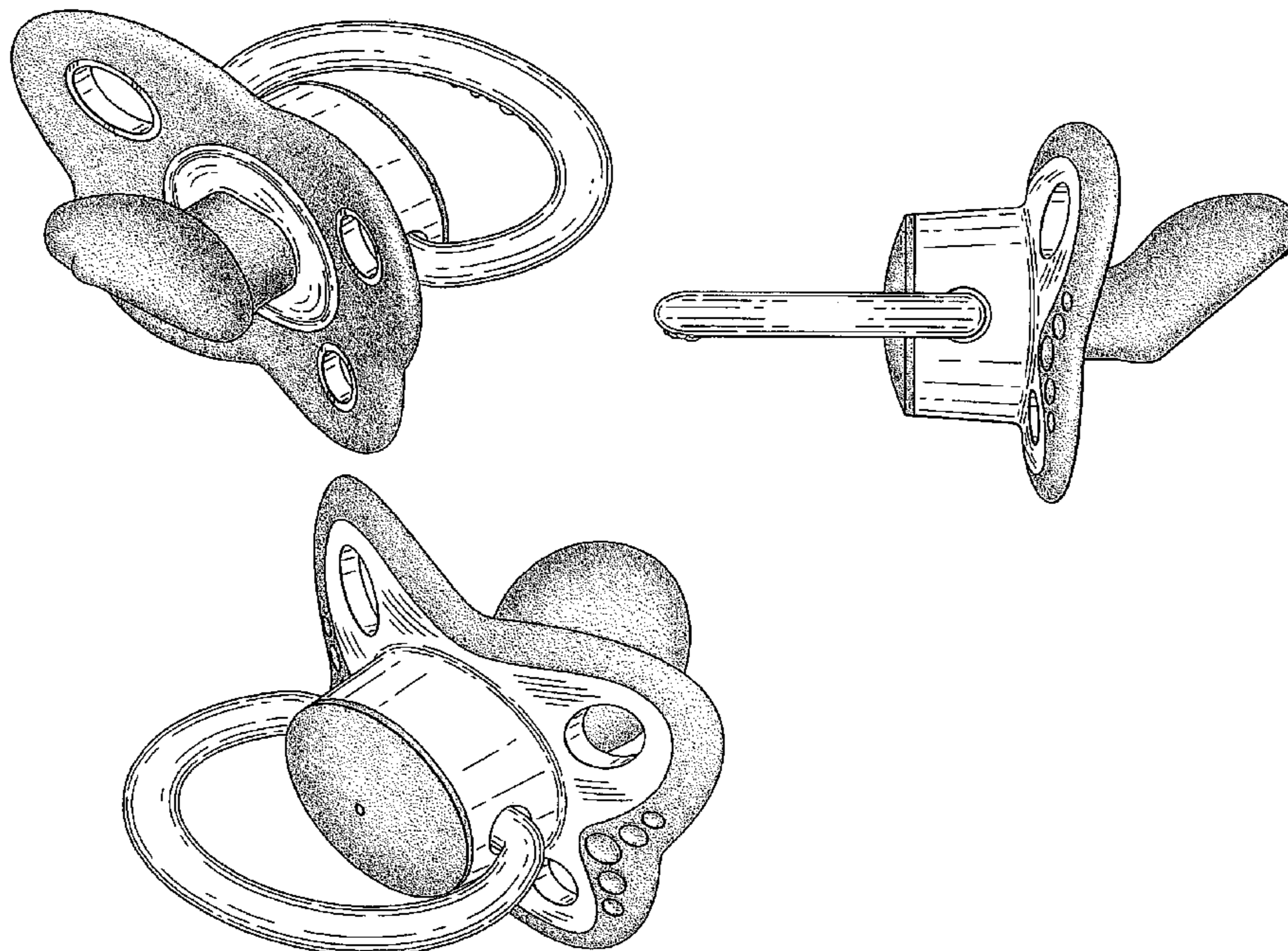

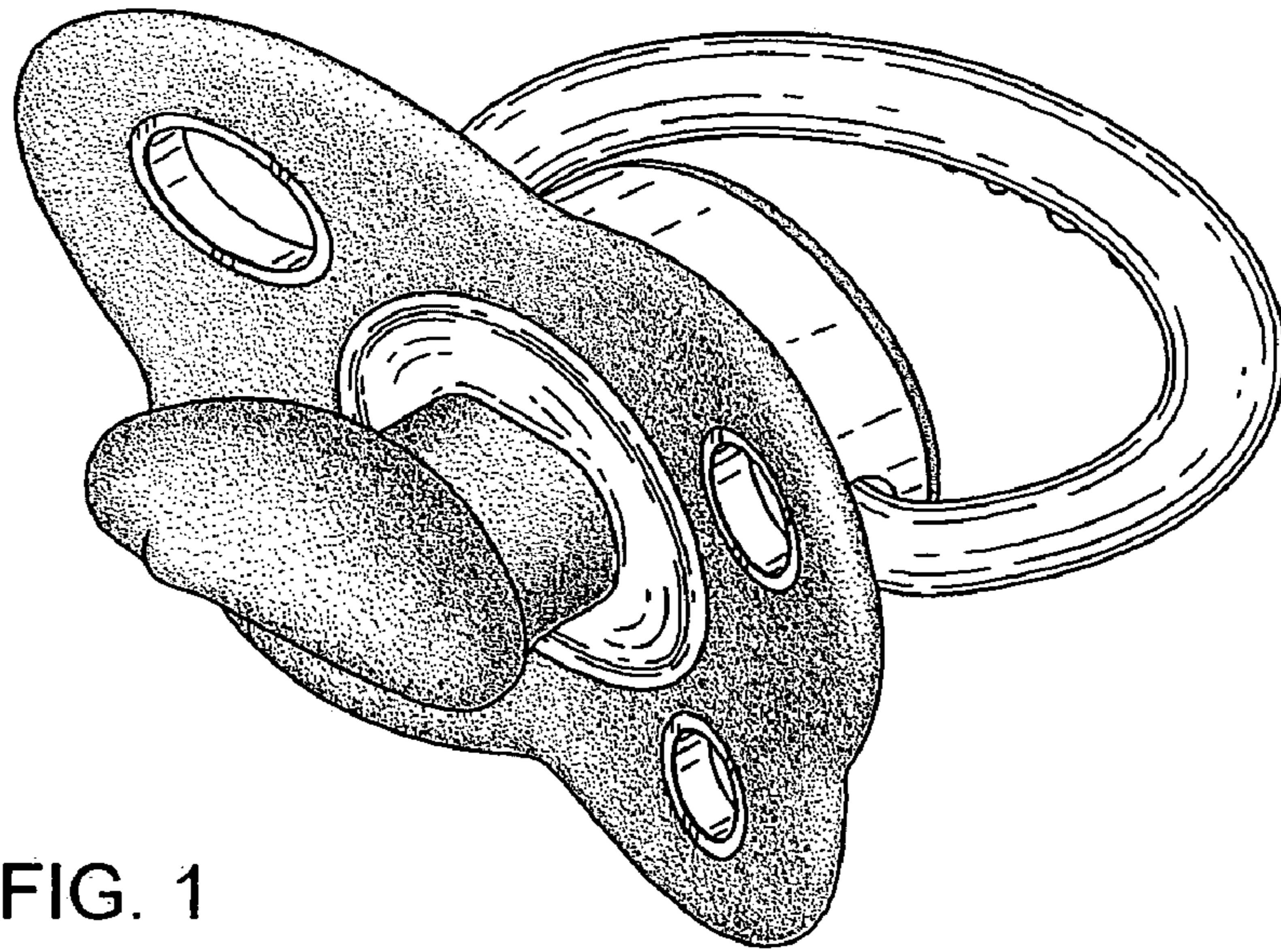

FIG. 1

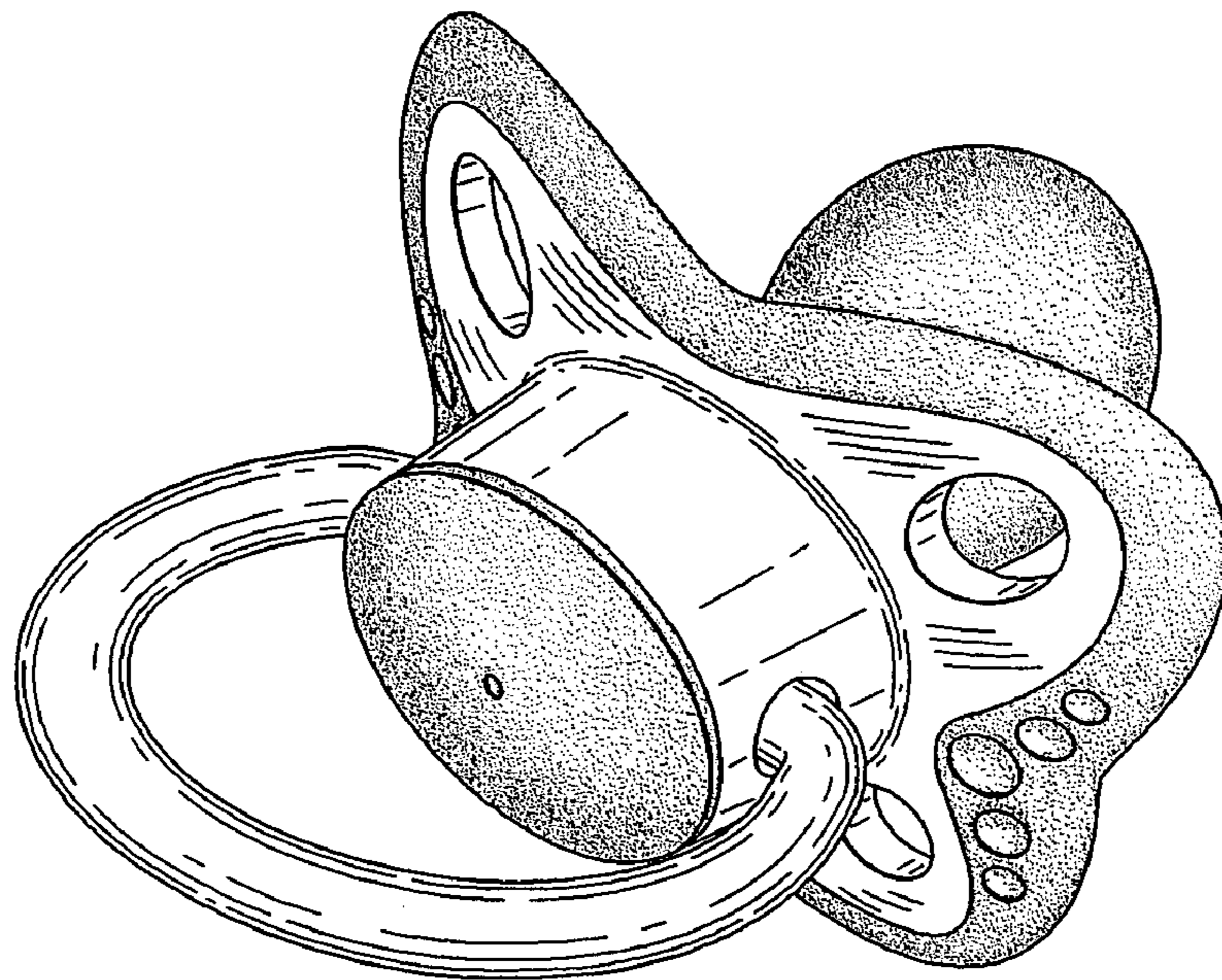

FIG. 2

FIG. 3

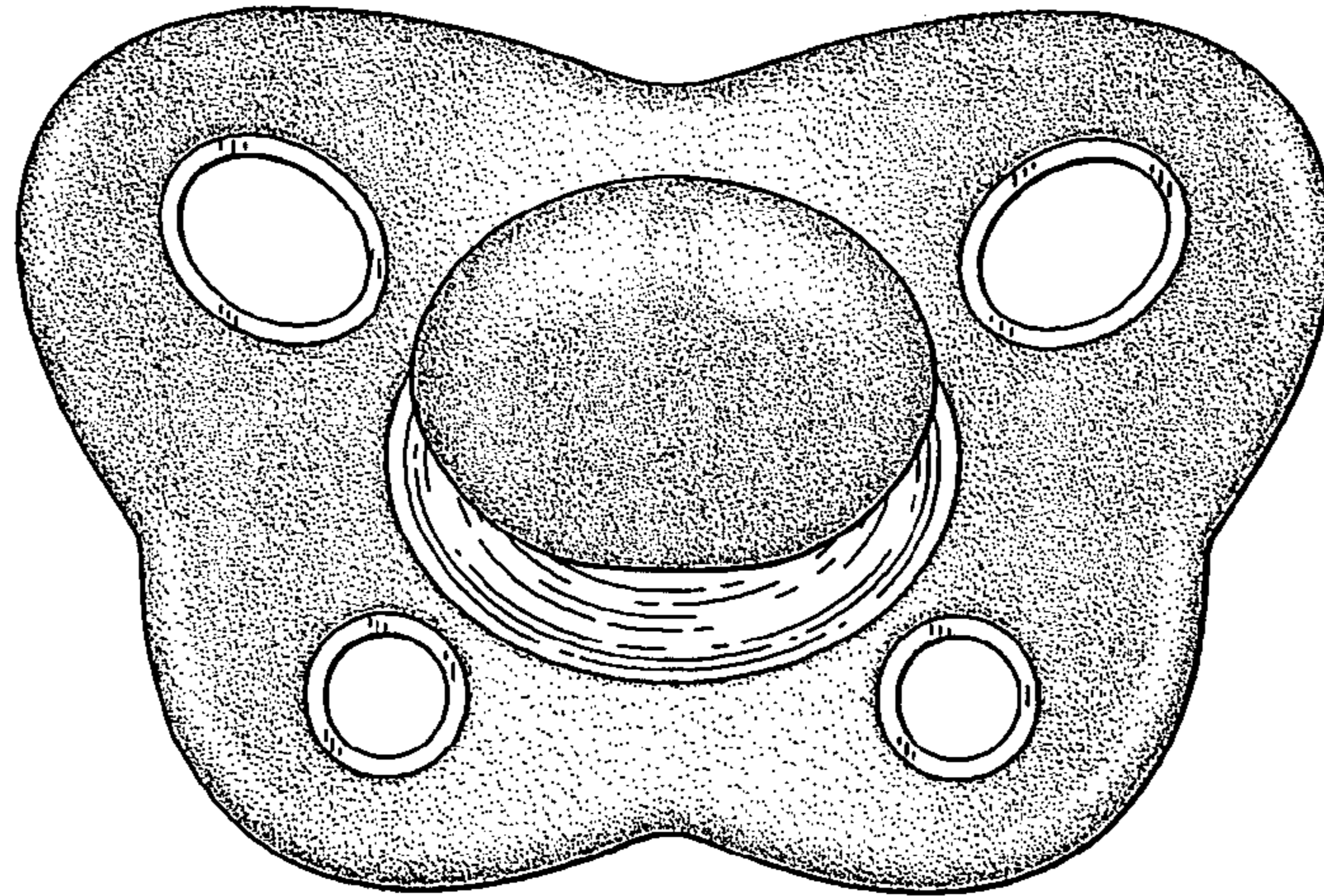

FIG. 4

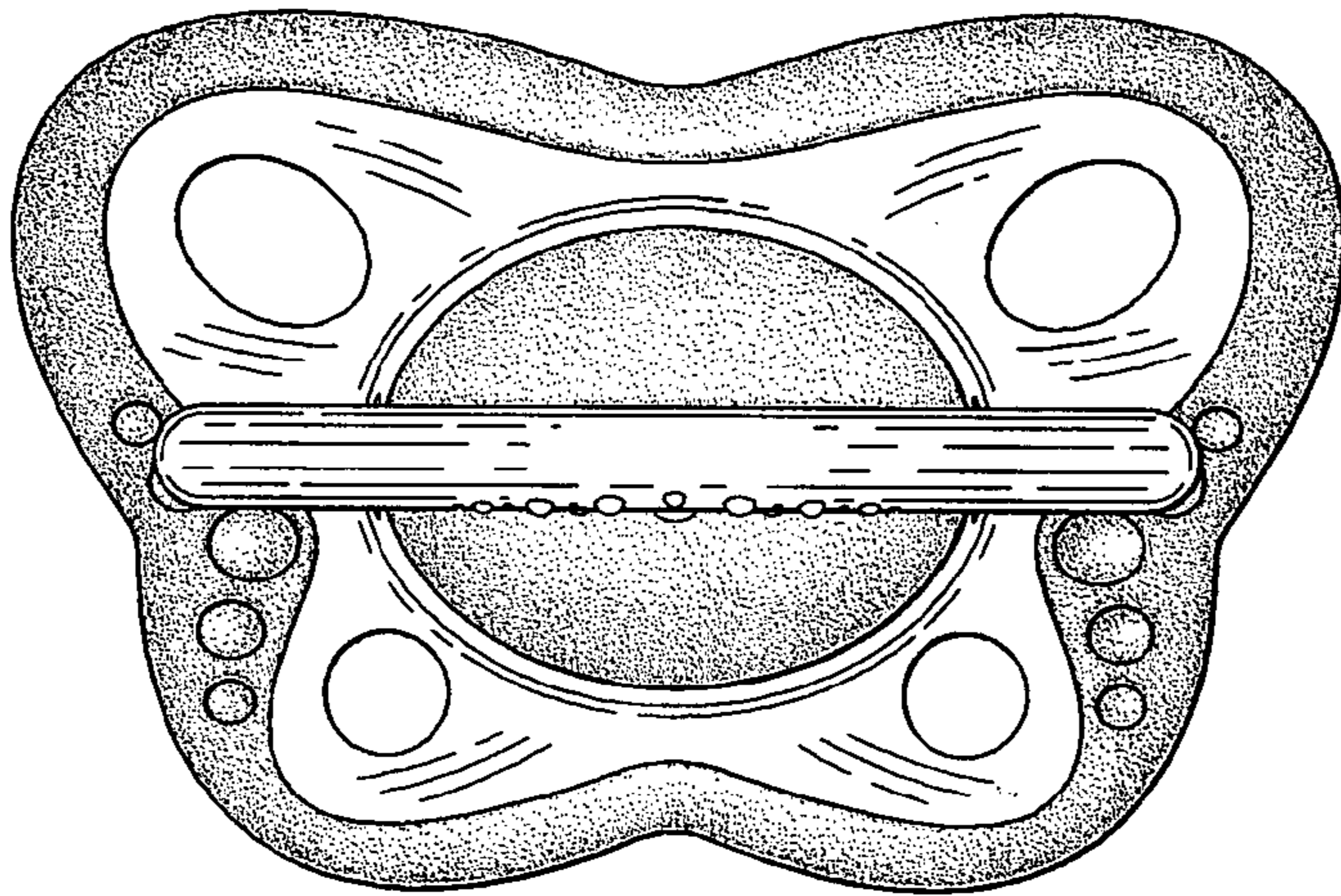
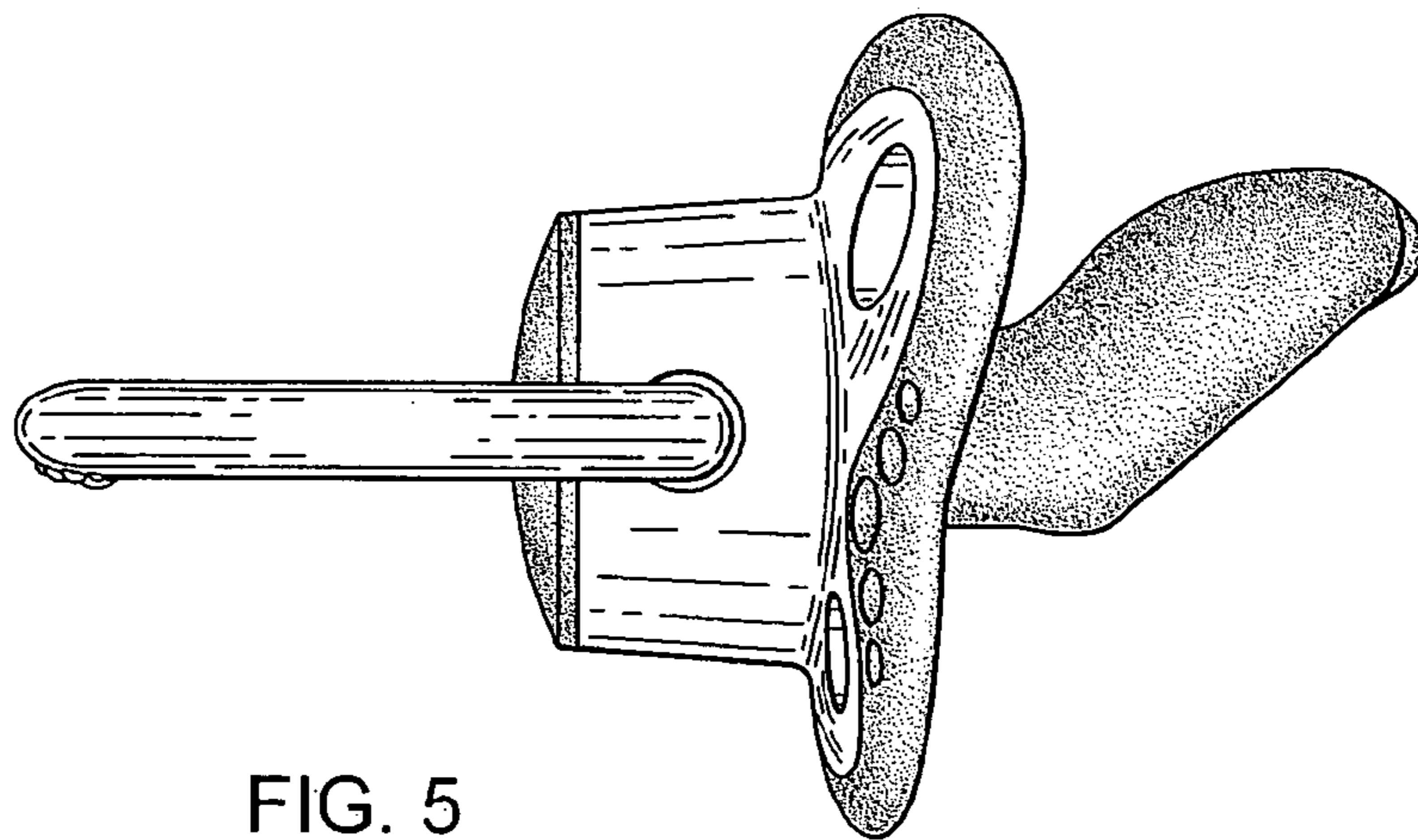

FIG. 5



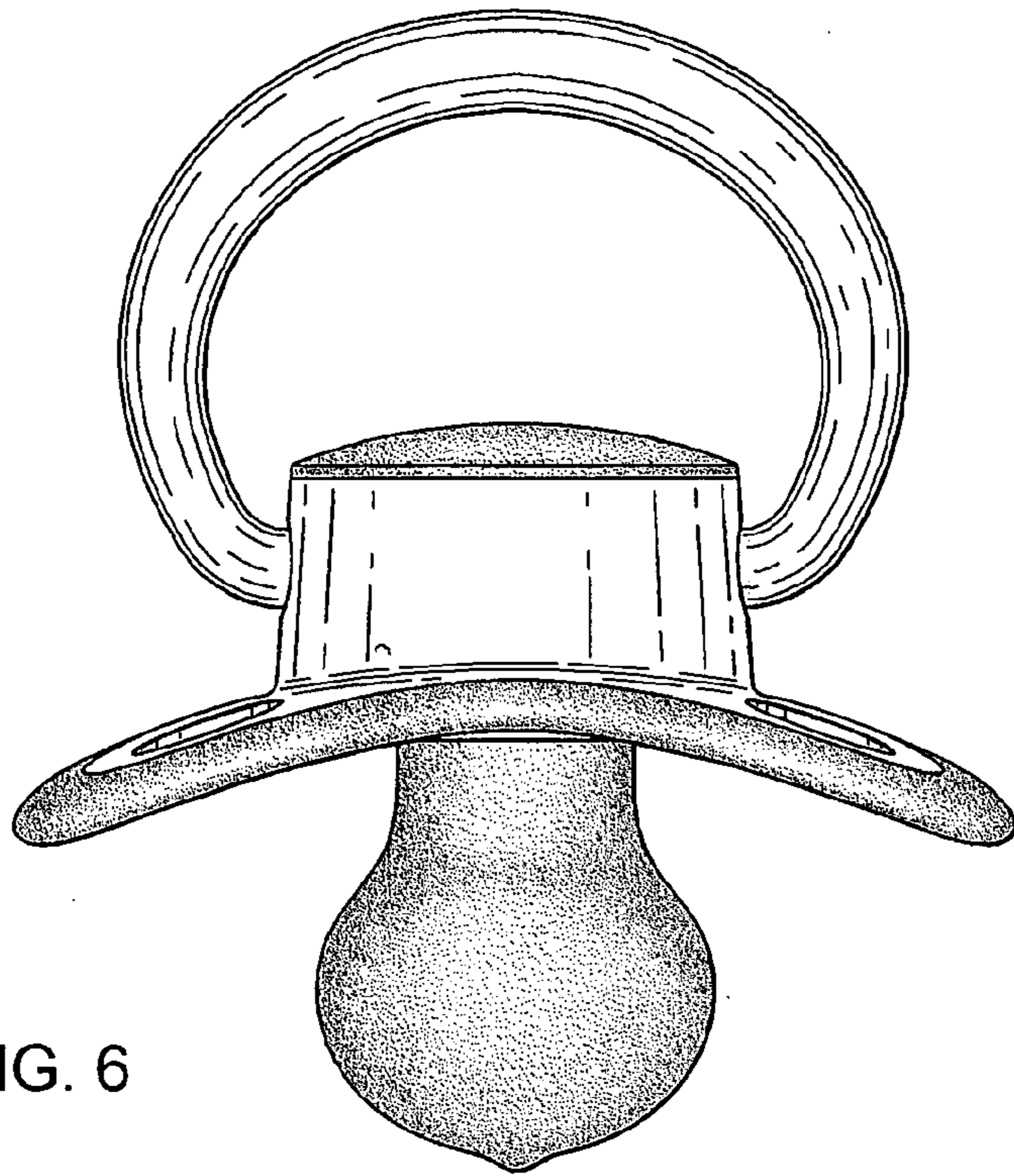

FIG. 6

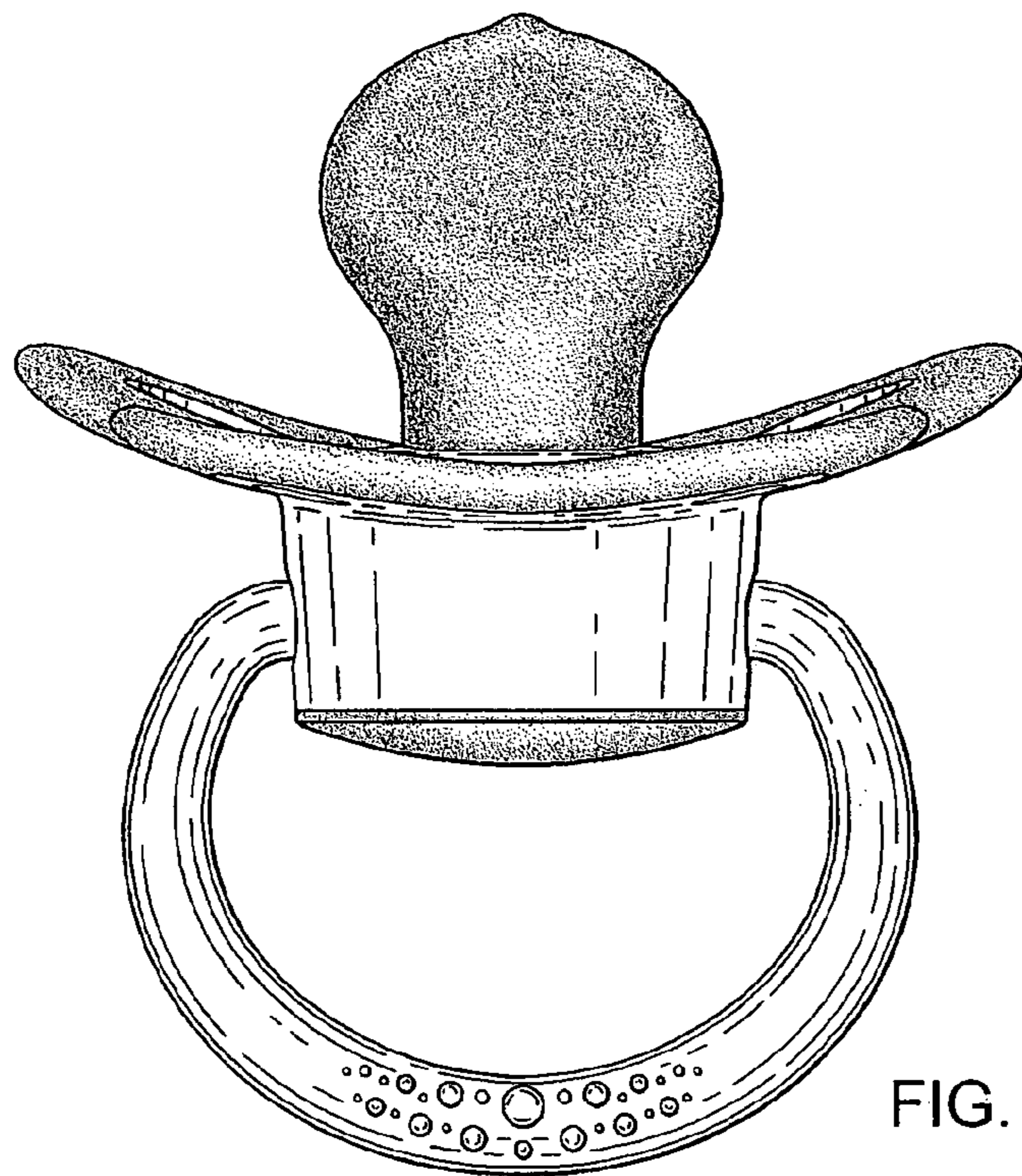

FIG. 7