



US00D559352S

(12) **United States Design Patent**
Lo

(10) **Patent No.:** **US D559,352 S**
(45) **Date of Patent:** **** Jan. 8, 2008**

(54) **SPRINKLER BASE**

(75) Inventor: **Shun Nan Lo**, Changhua Hsien (TW)

(73) Assignee: **Yuan Mei Corp.**, Changhua Hsien (TW)

(**) Term: **14 Years**

(21) Appl. No.: **29/268,975**

(22) Filed: **Nov. 17, 2006**

(51) **LOC (8) Cl.** **23-01**

(52) **U.S. Cl.** **D23/221**

(58) **Field of Classification Search** D23/214,
D23/216, 221; 239/273–275, 276, 242
See application file for complete search history.

(56) **References Cited**

U.S. PATENT DOCUMENTS

5,657,928 A * 8/1997 Jian 239/242
6,478,241 B1 * 11/2002 Guo 239/562
D500,122 S * 12/2004 Schapper D23/221

* cited by examiner

Primary Examiner—Robin V Webster

(74) *Attorney, Agent, or Firm*—Troxell Law Office, PLLC

(57) **CLAIM**

The ornamental design for the “sprinkler base,” as shown and described.

DESCRIPTION

FIG. 1 is a perspective view of a sprinkler base showing my new design;

FIG. 2 is a front view thereof;

FIG. 3 is a rear view thereof;

FIG. 4 is a left side view thereof;

FIG. 5 is a right side view thereof;

FIG. 6 is a top view thereof;

FIG. 7 is a bottom view thereof;

FIG. 8 is a diagram showing the operation status of the first sprinkler mounted to the base thereof; and,

FIG. 9 is a diagram showing the operation status of the second sprinkler mounted to the base thereof.

The broken line showing of the sprinklers mounted in the claimed design in FIGS. 8 and 9 are included for the purpose of illustrating and forms no part of the claimed design.

1 Claim, 8 Drawing Sheets

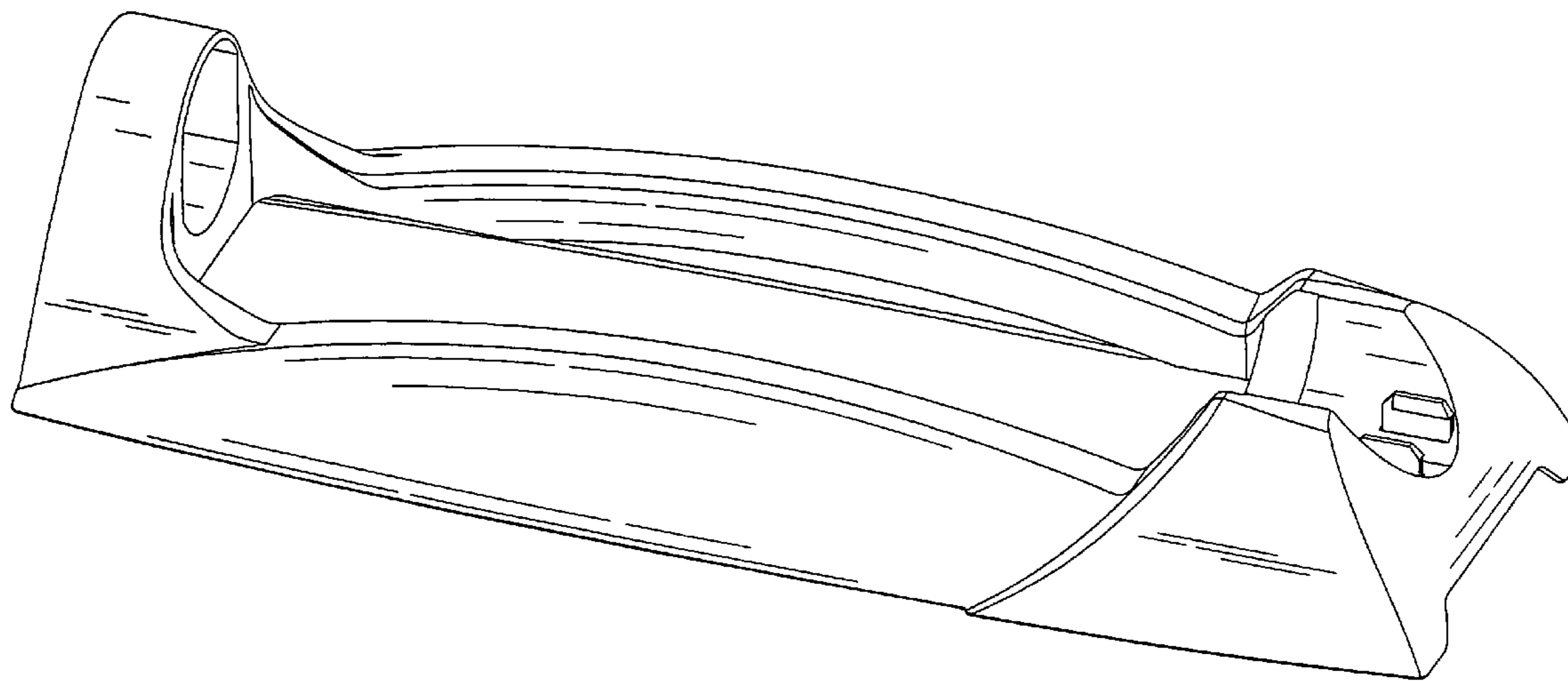

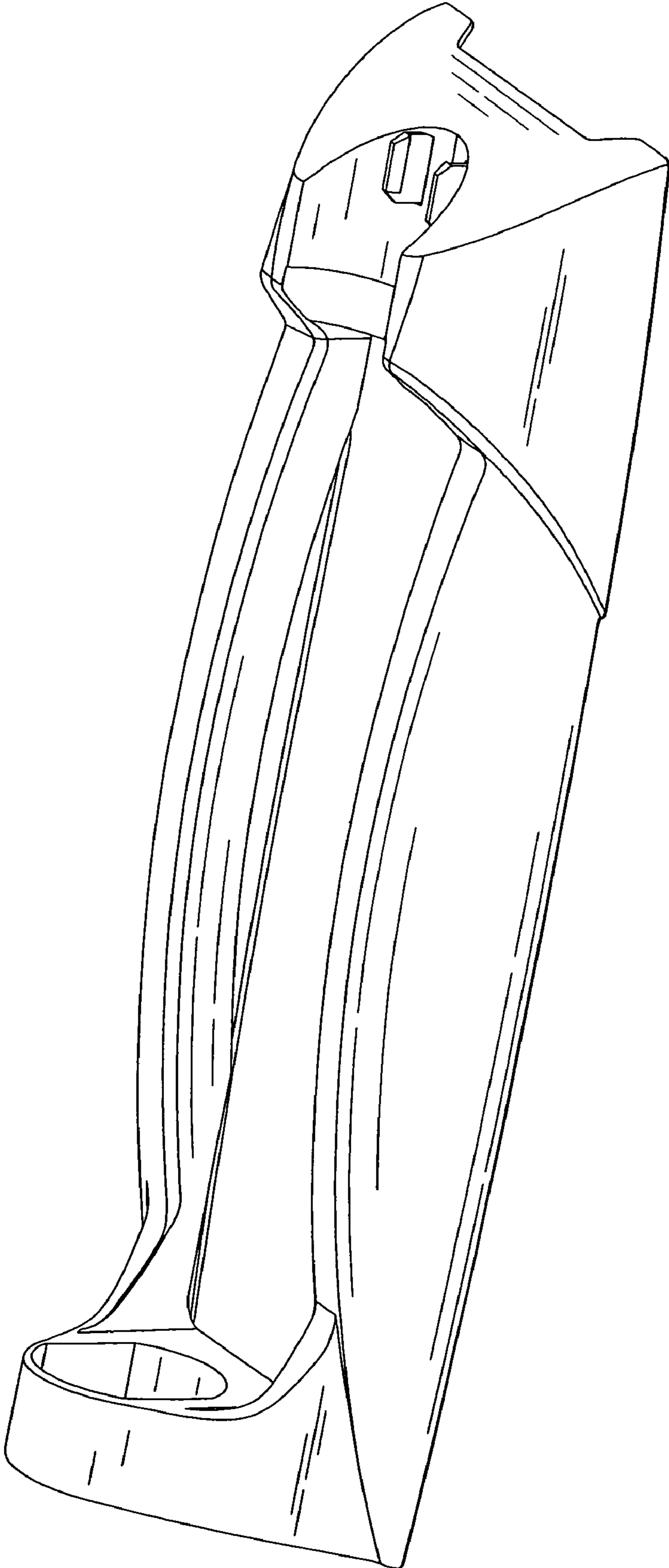

FIG. 1



FIG. 2

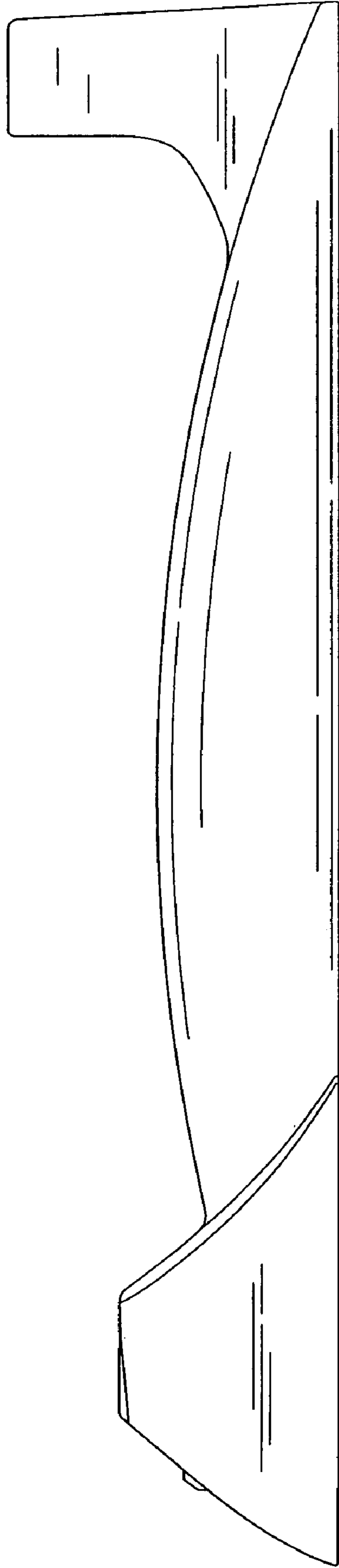

FIG. 3

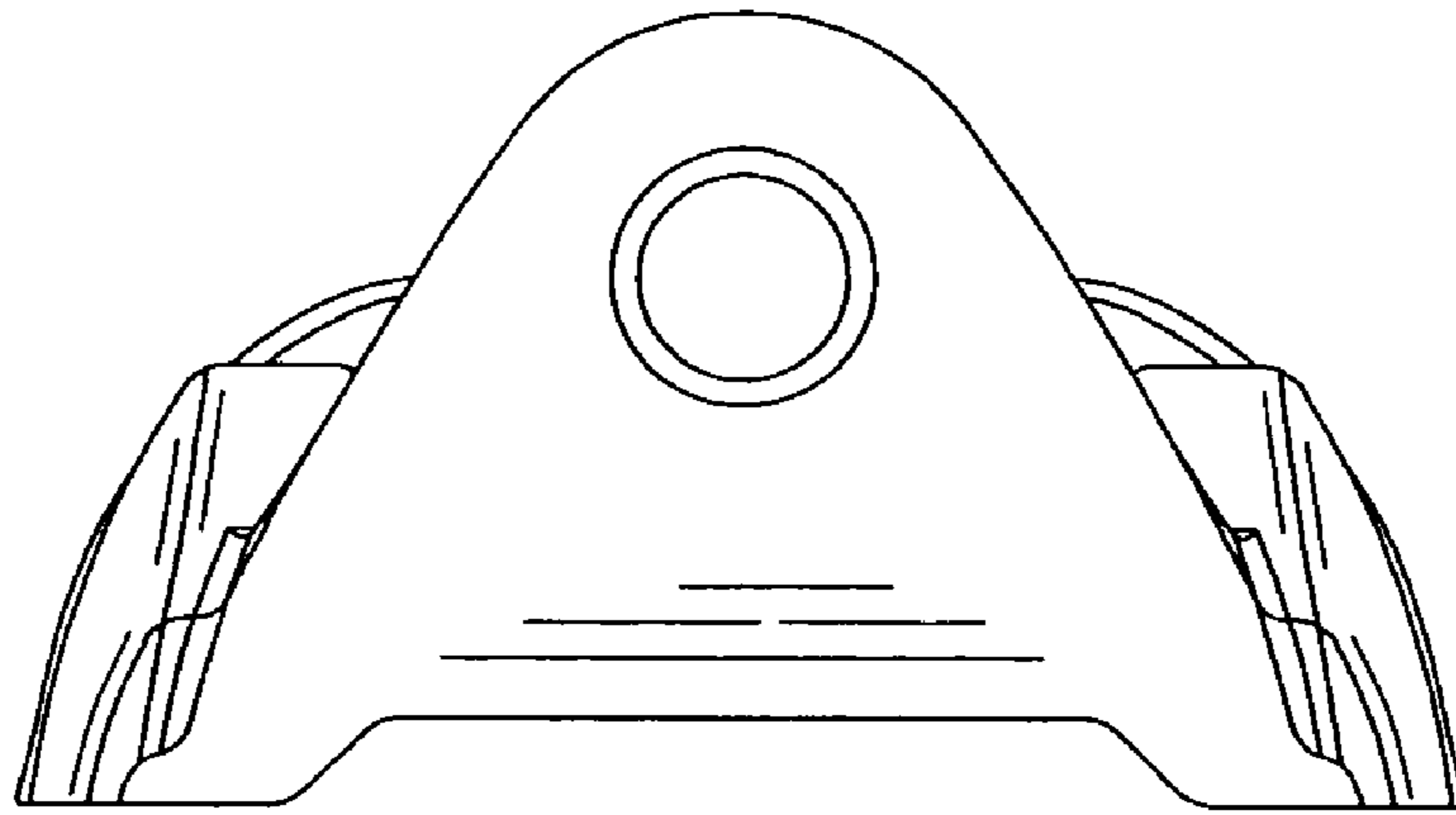

FIG. 4

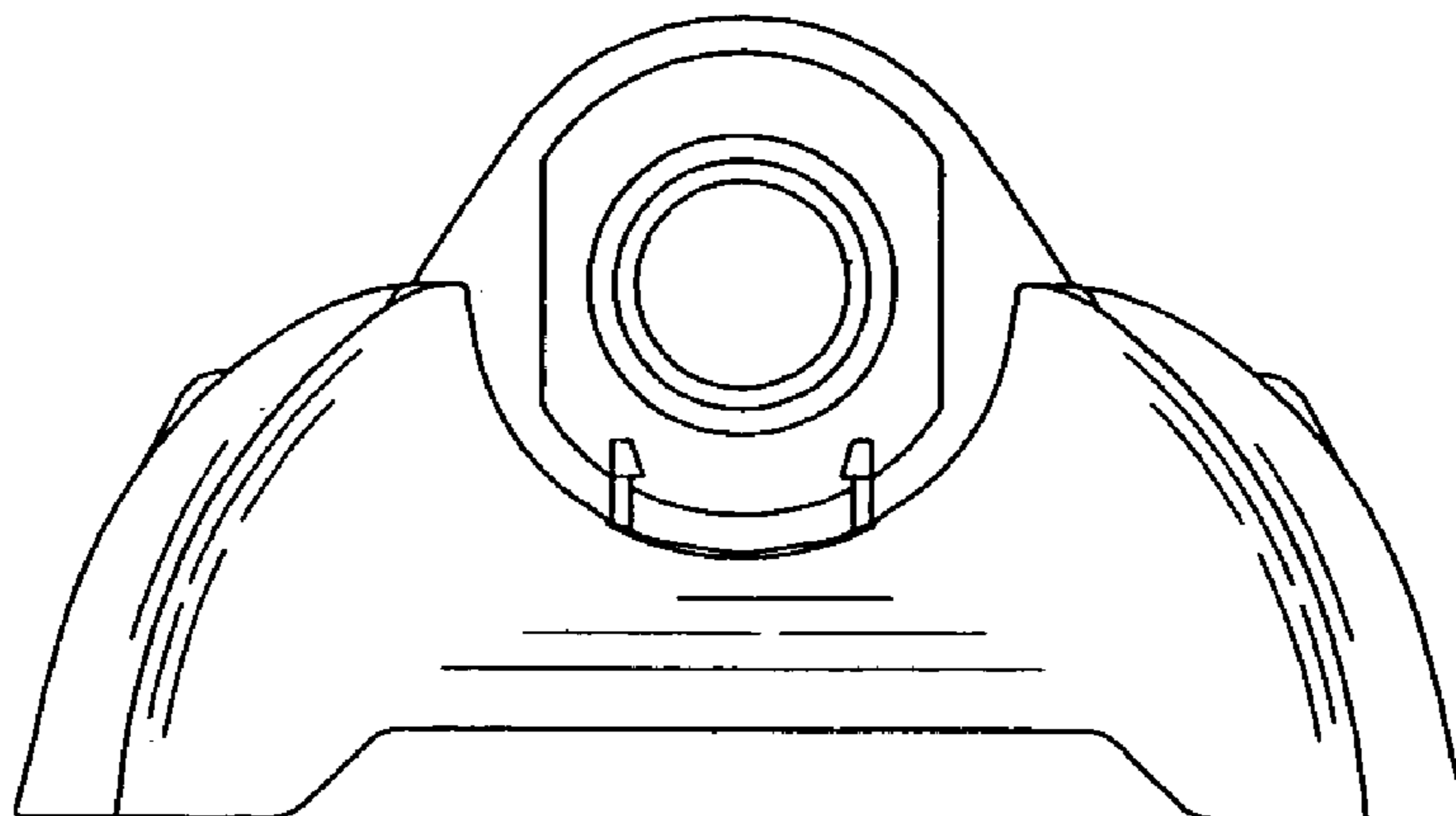

FIG. 5

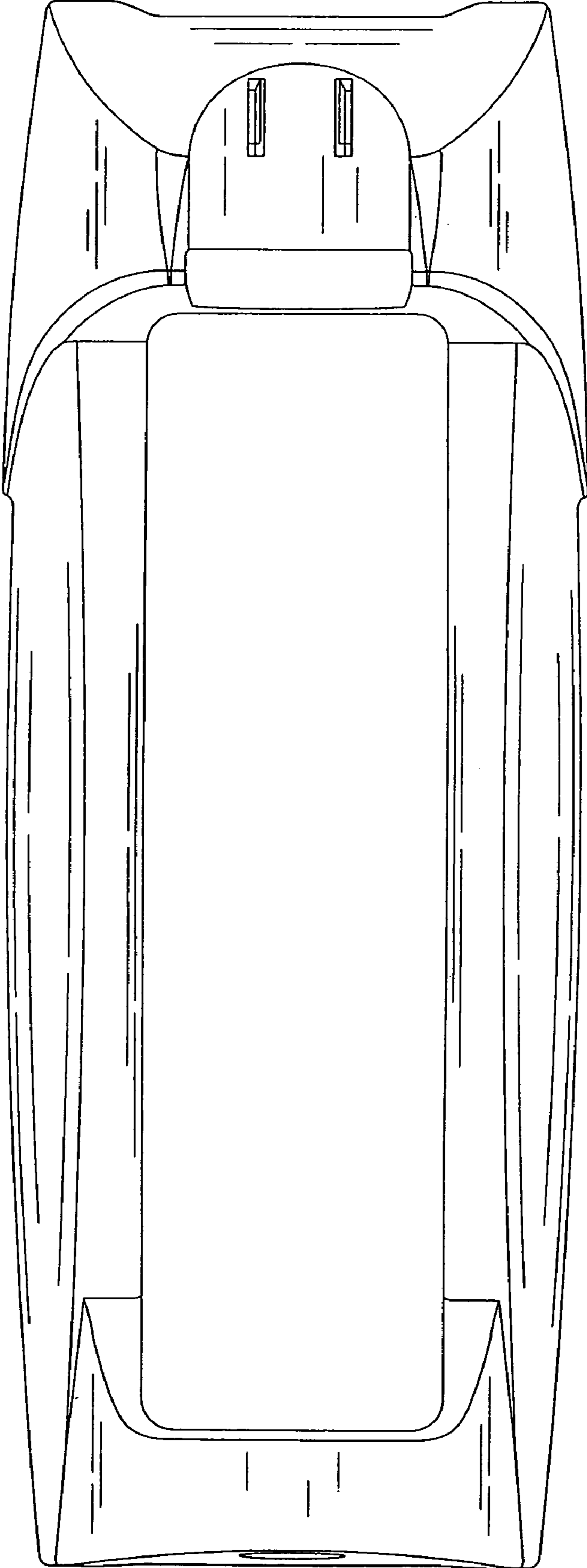

FIG. 6

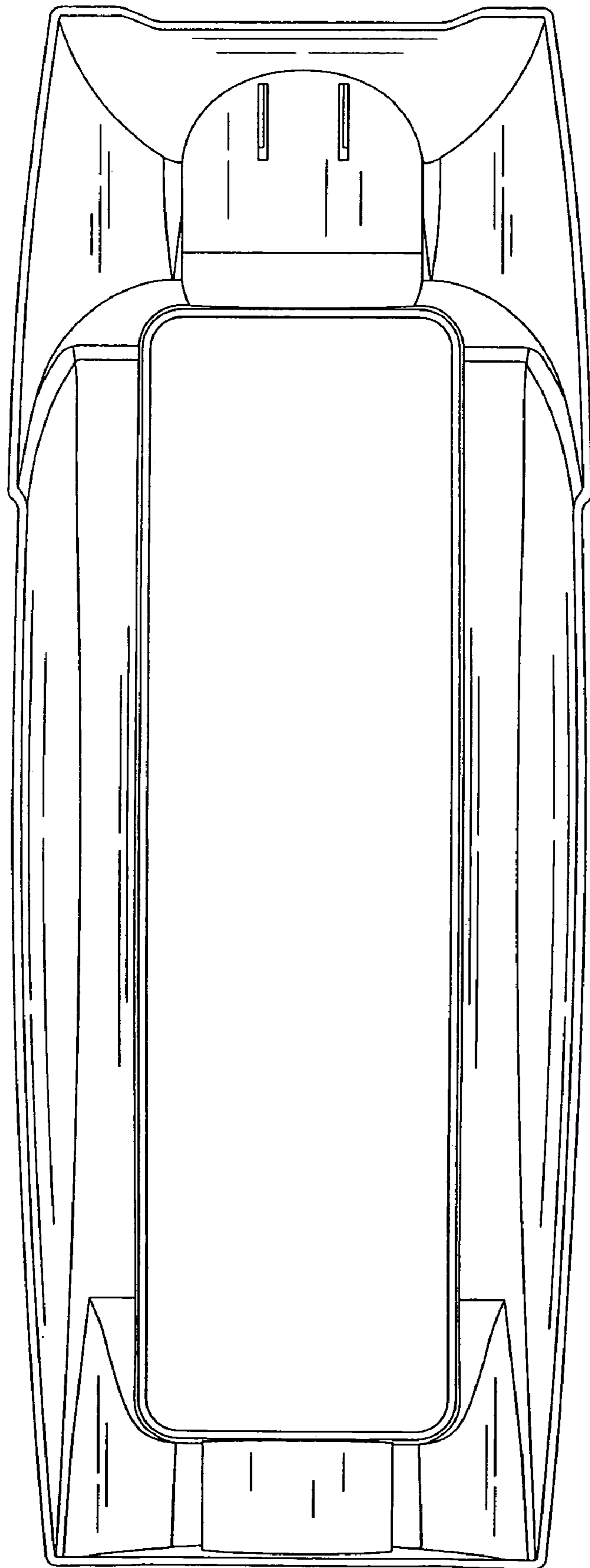

FIG. 7

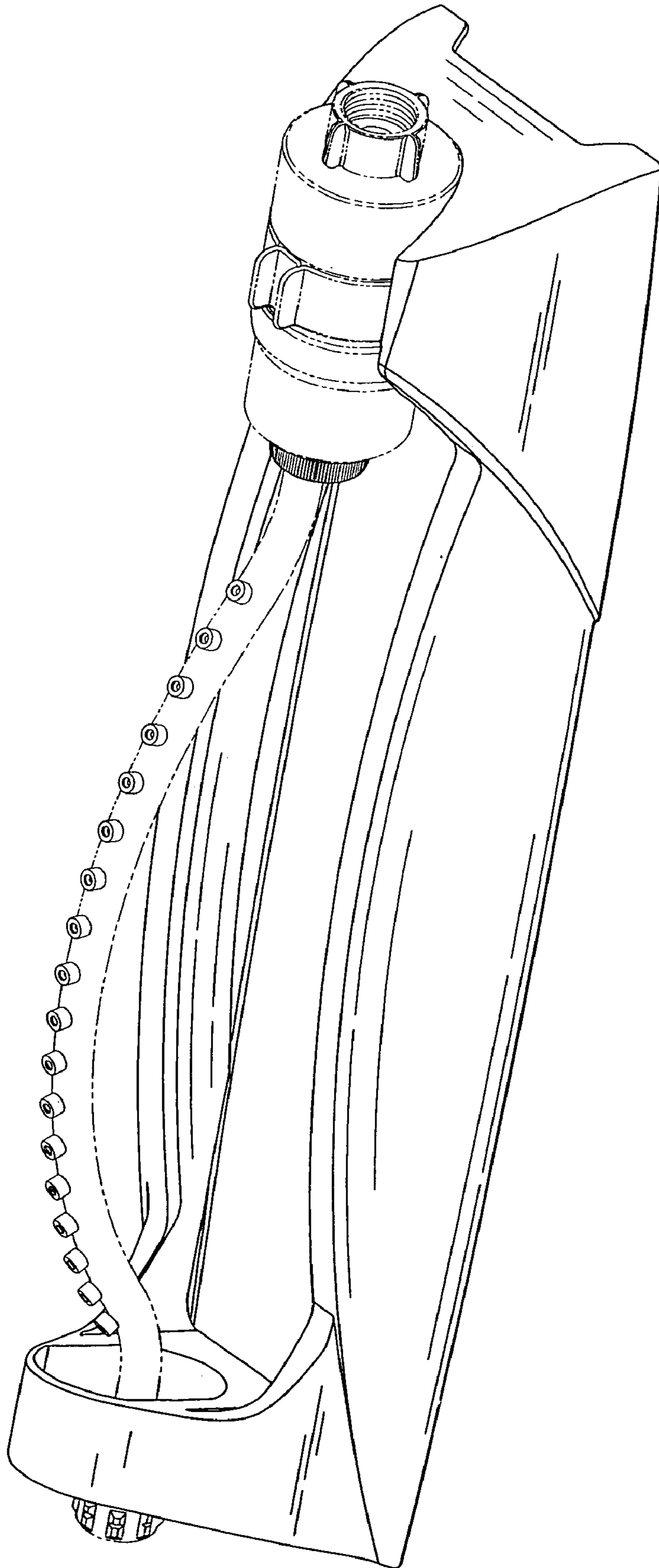

FIG. 8

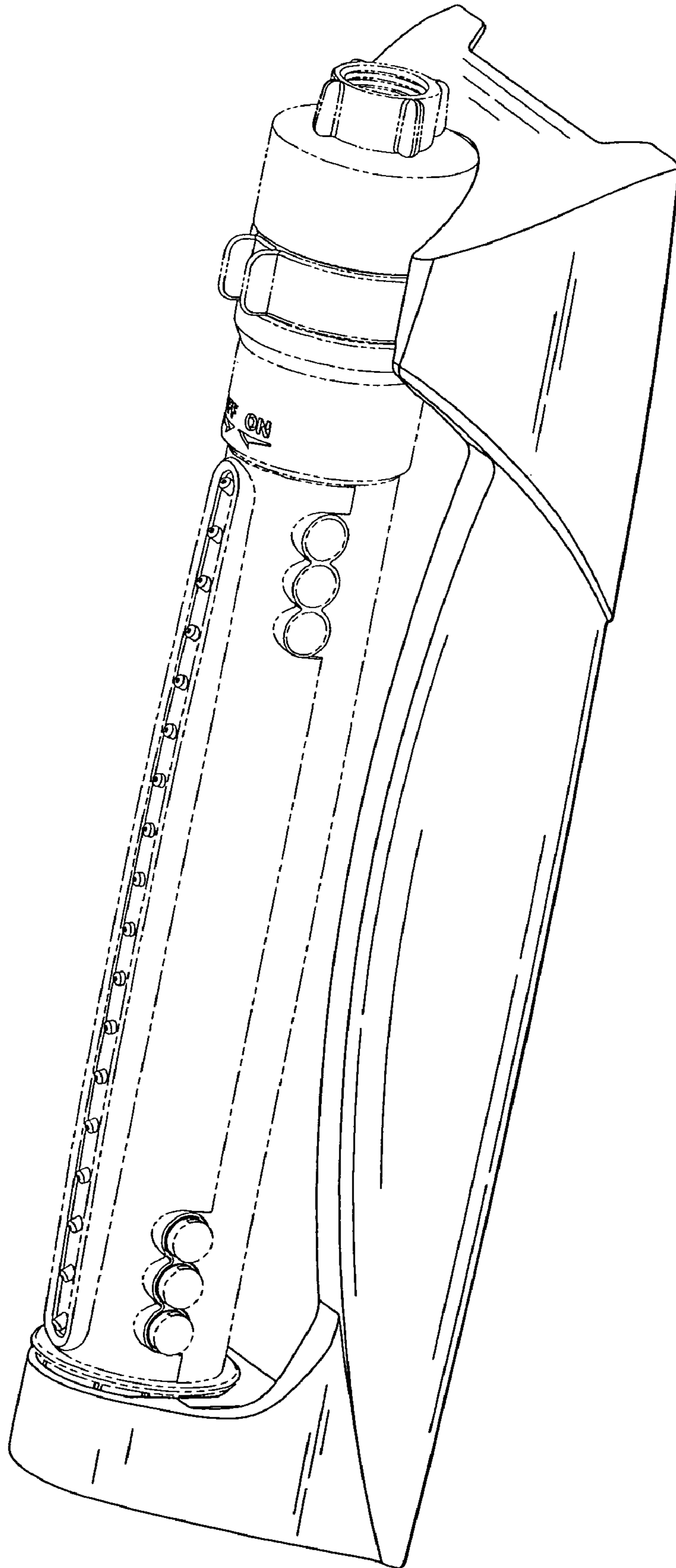

FIG. 9