



US00D559350S

(12) **United States Design Patent**  
**Huang**

(10) **Patent No.:** **US D559,350 S**

(45) **Date of Patent:** **\*\* Jan. 8, 2008**

(54) **SPRAYER**

(76) Inventor: **Jin-Yuan Huang**, No. 62, Chung-Shan Shih St., Kuei-Jen Hsiang, Tainan Hsien (TW)

(\*\*) Term: **14 Years**

(21) Appl. No.: **29/275,561**

(22) Filed: **Dec. 29, 2006**

(51) **LOC (8) Cl.** ..... **23-01**

(52) **U.S. Cl.** ..... **D23/213**

(58) **Field of Classification Search** ..... D23/213, D23/223, 229; 239/525-7, 459-460  
See application file for complete search history.

(56) **References Cited**

**U.S. PATENT DOCUMENTS**

- D106,697 S \* 10/1937 Slater ..... D23/229
- D159,174 S \* 6/1950 Thompson ..... D23/229
- D186,645 S \* 11/1959 Benjamin ..... D23/229

D189,411 S \* 12/1960 Gilmour ..... D23/229

\* cited by examiner

*Primary Examiner*—Robin V Webster

(74) *Attorney, Agent, or Firm*—Caesar, Rivise, Bernstein, Cohen & Pokotilow, Ltd.

(57) **CLAIM**

The ornamental design for sprayer, as shown and described.

**DESCRIPTION**

FIG. 1 is a perspective view of a sprayer showing my new design;

FIG. 2 is a front elevational view thereof;

FIG. 3 is a rear elevational view thereof;

FIG. 4 is a left side elevational view thereof;

FIG. 5 is a right side elevational view thereof;

FIG. 6 is a top plan view thereof; and,

FIG. 7 is a bottom plan view thereof.

**1 Claim, 6 Drawing Sheets**

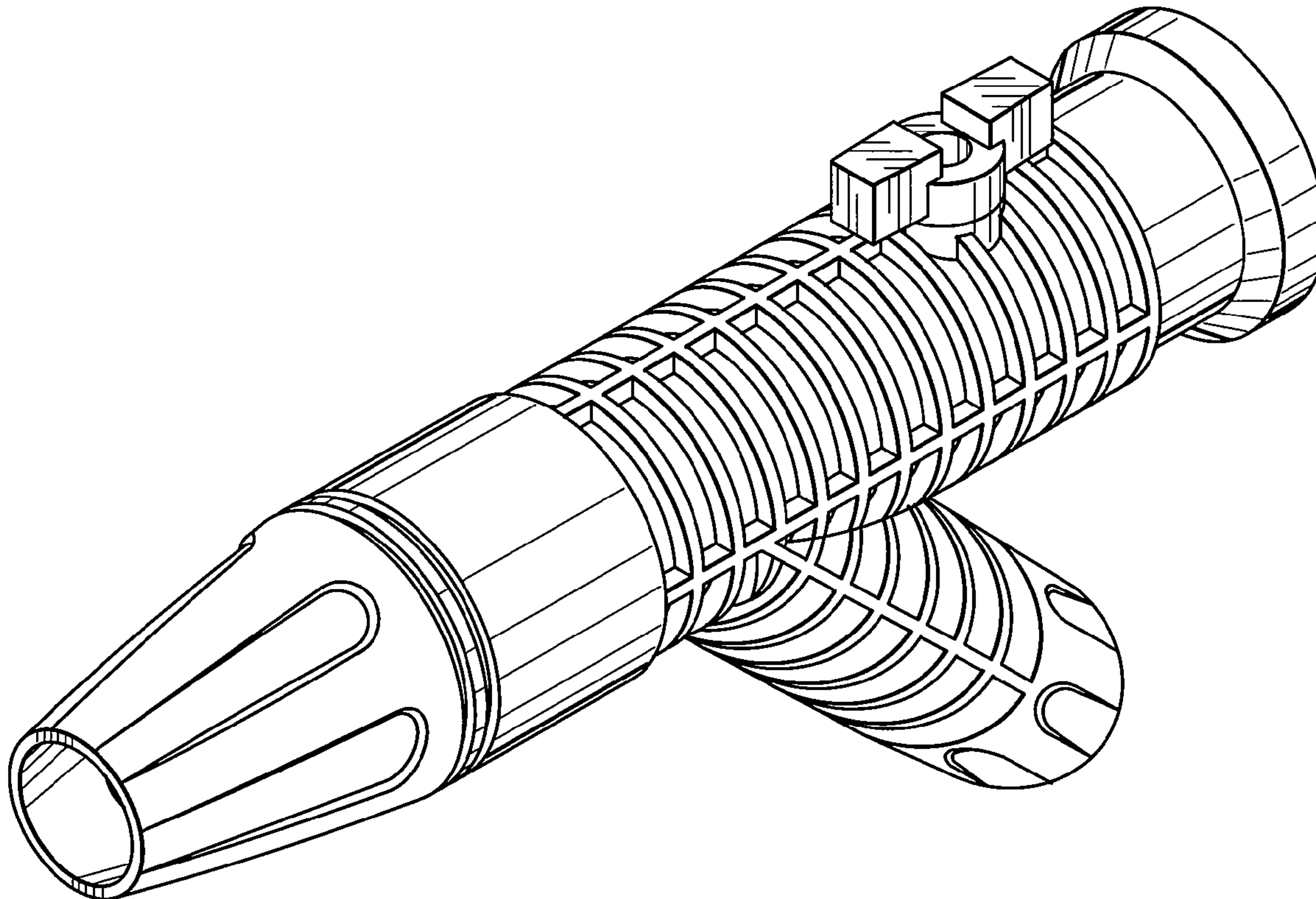

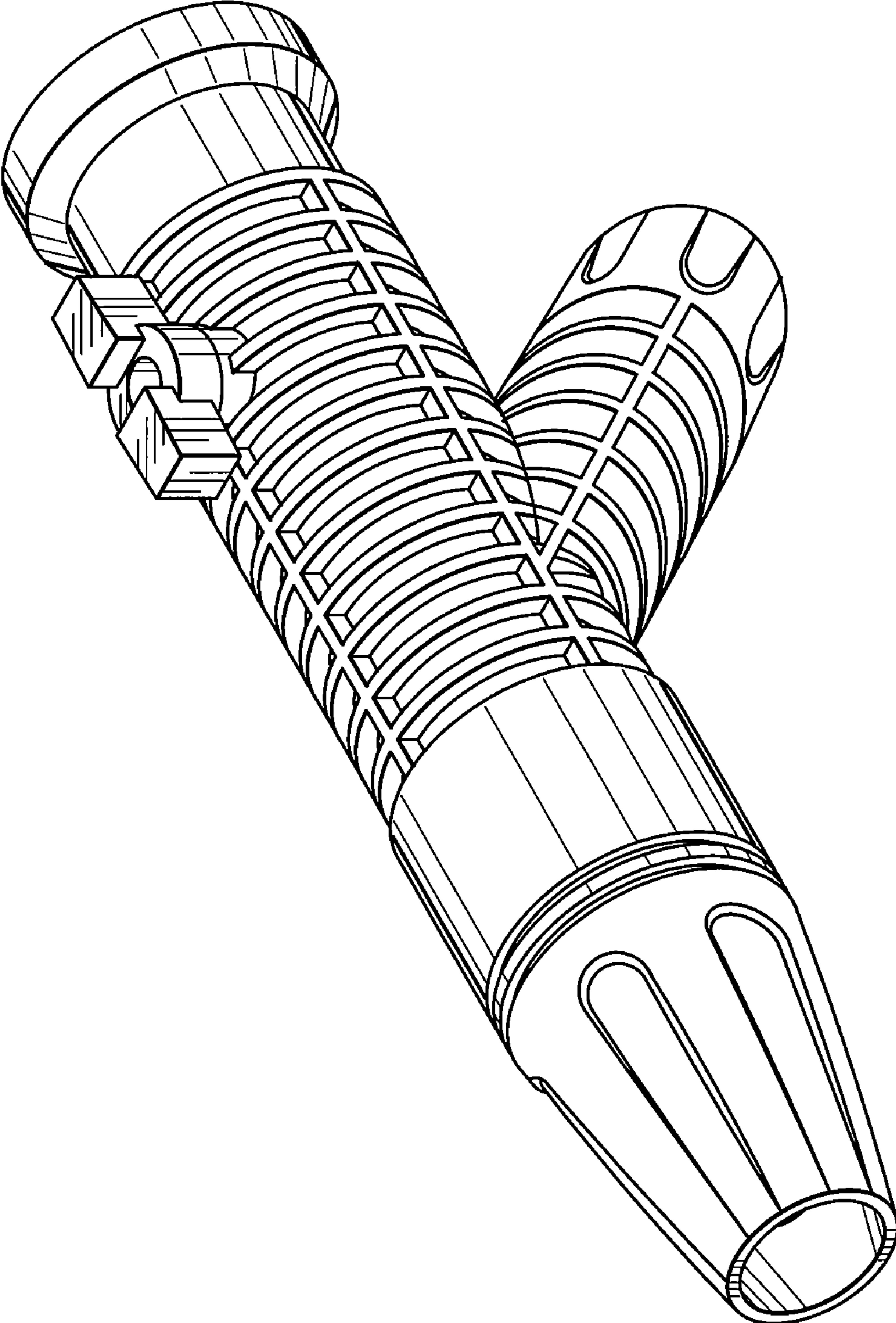

FIG. 1

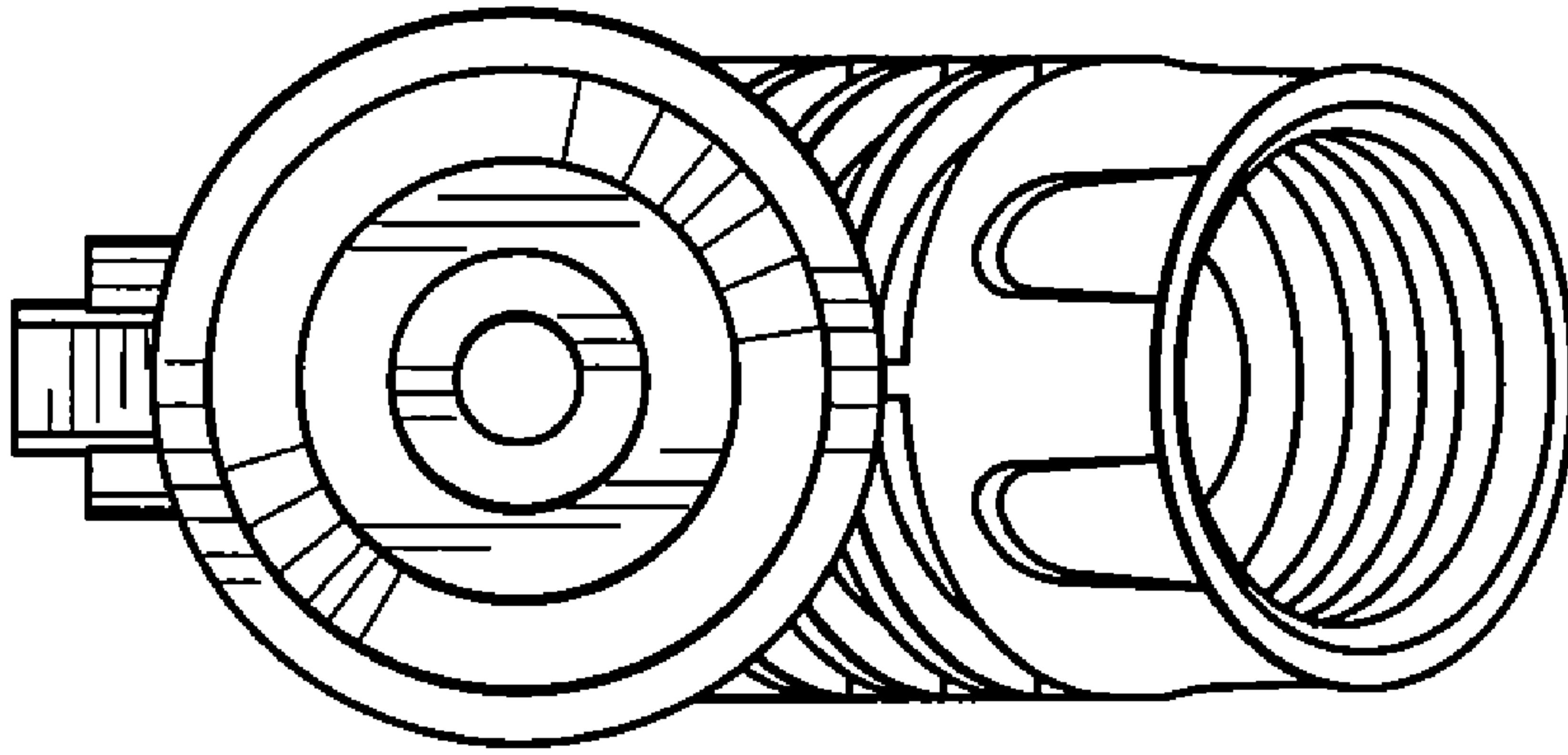

FIG. 3

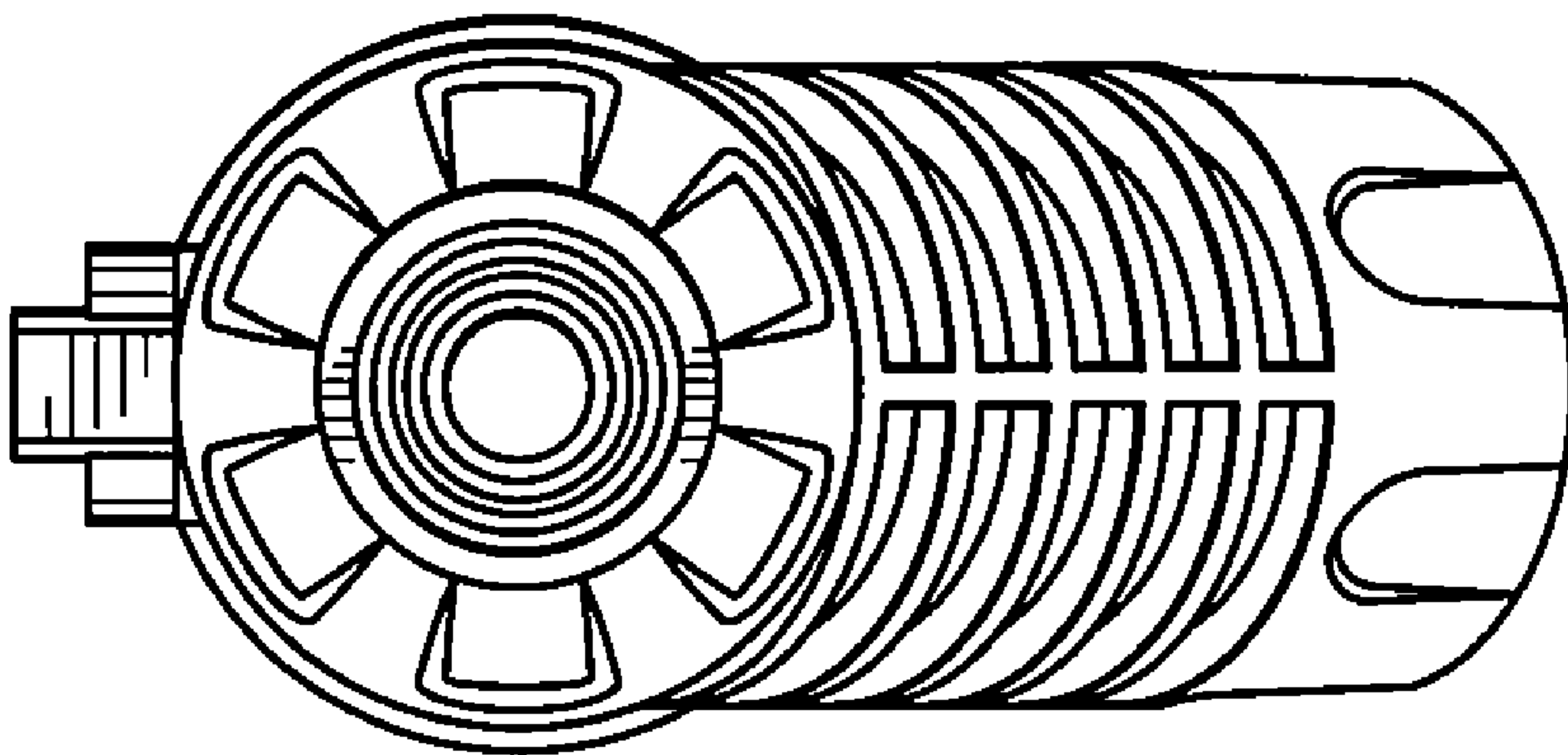

FIG. 2

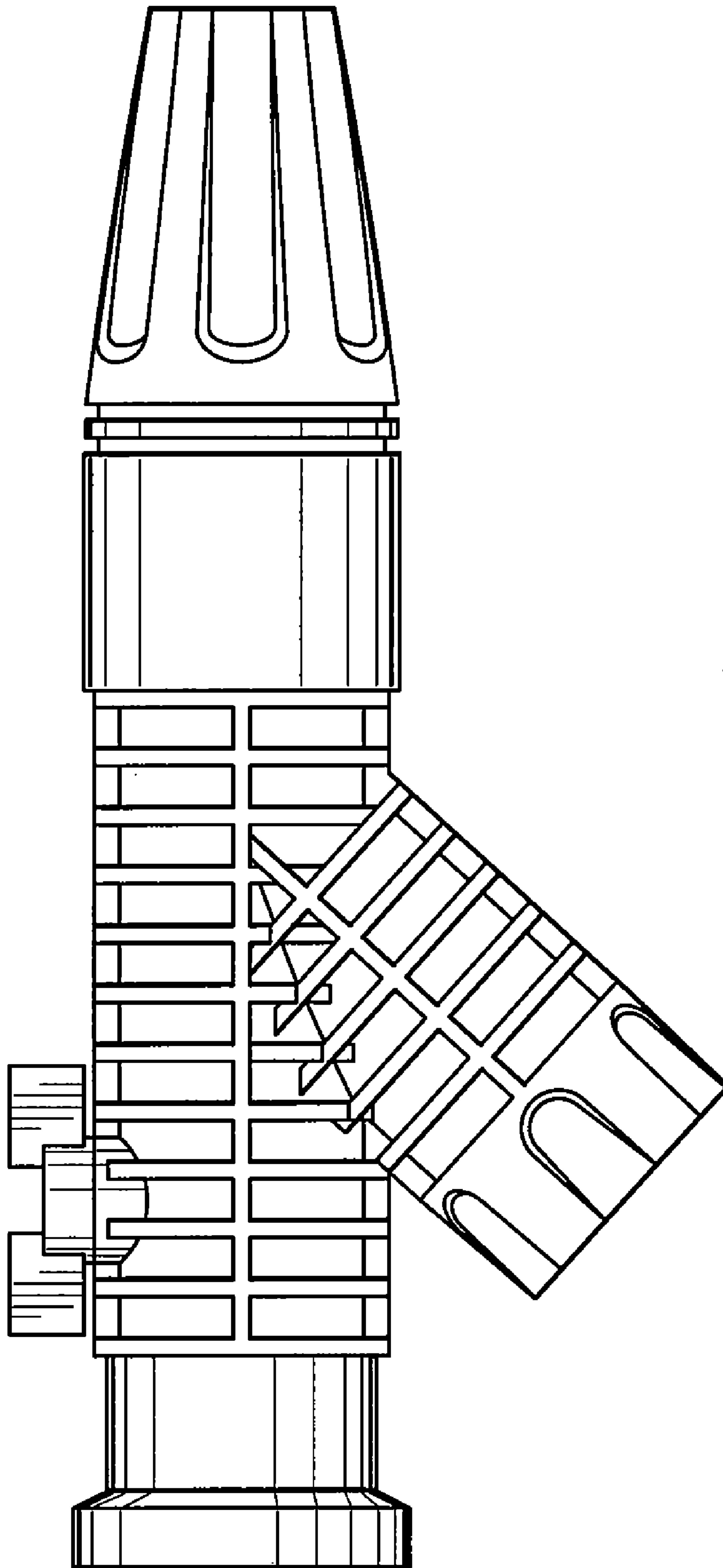

FIG. 4

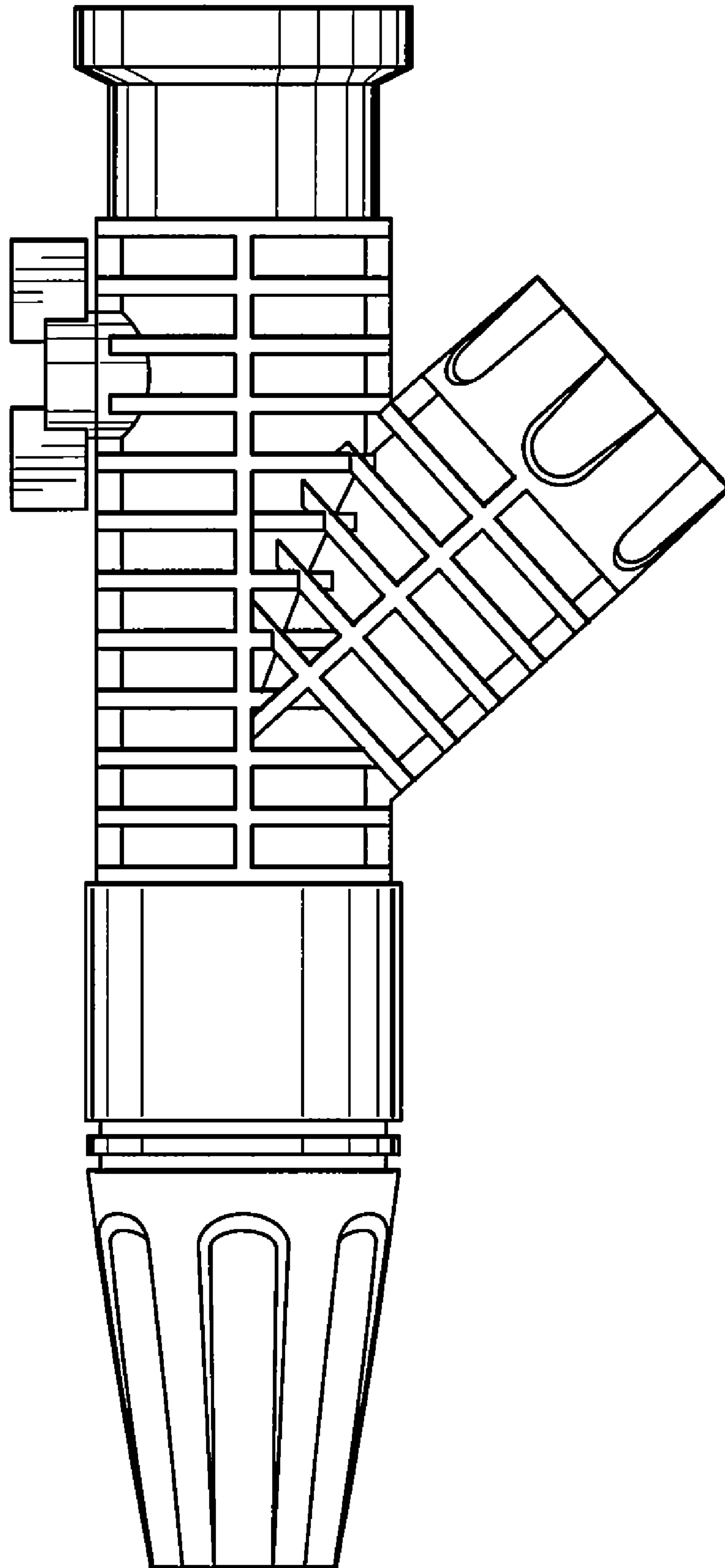

FIG. 5



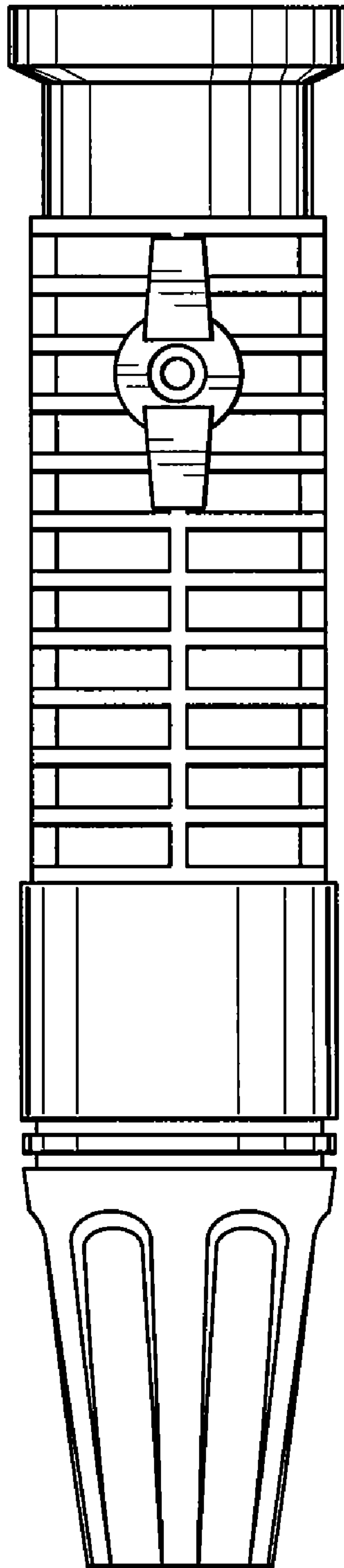

FIG. 6

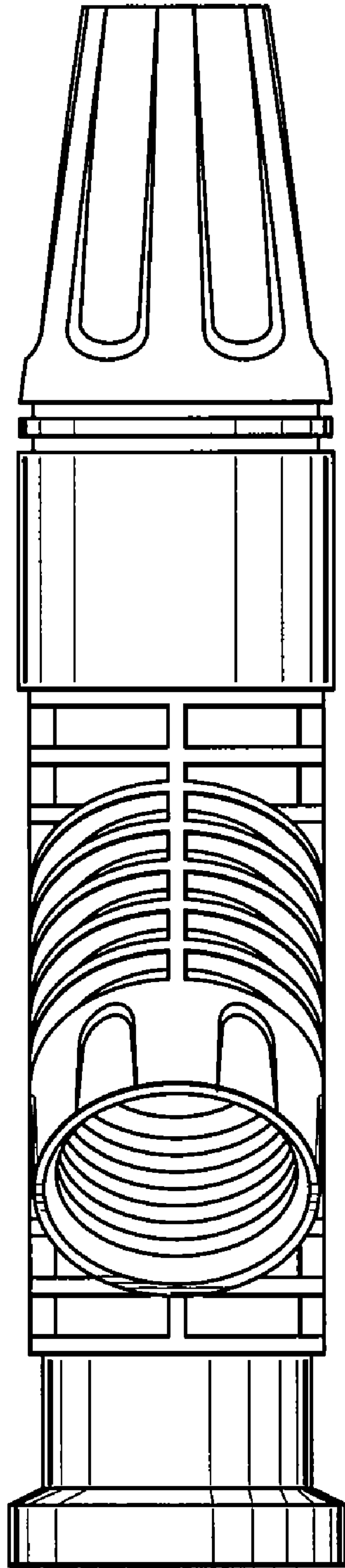

FIG. 7