



US00D559218S

(12) **United States Design Patent** (10) **Patent No.:** **US D559,218 S**  
**Park et al.** (45) **Date of Patent:** **\*\* Jan. 8, 2008**

(54) **MOBILE PHONE**

(75) Inventors: **Bum-Soo Park**, Gwangmyeong-si (KR); **Nam-Mi Kim**, Seoul (KR); **Chang-Hwan Hwang**, Goyang-si (KR)

(73) Assignee: **Samsung Electronics Co., Ltd.**, Suwon-Si (KR)

(\*\*) Term: **14 Years**

(21) Appl. No.: **29/259,116**

(22) Filed: **May 3, 2006**

(30) **Foreign Application Priority Data**

Feb. 6, 2006 (KR) ..... 30-2006-0004162

(51) **LOC (8) Cl.** ..... **14-03**

(52) **U.S. Cl.** ..... **D14/138**

(58) **Field of Classification Search** ..... D14/496,  
D14/138, 341-347; 455/575.3, 575.1; D21/517,  
D21/329, 333

See application file for complete search history.

(56) **References Cited**

**U.S. PATENT DOCUMENTS**

D352,503 S *	11/1994	Nagele	.....	D14/138
D446,201 S *	8/2001	Kim	.....	D14/138
D490,792 S *	6/2004	Lee	.....	D14/138
D496,014 S *	9/2004	Lodato et al.	.....	D14/138
D496,636 S *	9/2004	Lodato et al.	.....	D14/138
D500,750 S *	1/2005	Arnholt et al.	.....	D14/138
D501,838 S *	2/2005	Kim et al.	.....	D14/138
D512,395 S *	12/2005	Kim et al.	.....	D14/138
D512,975 S *	12/2005	Tsai et al.	.....	D14/138
D513,742 S *	1/2006	Arnholt et al.	.....	D14/138
D518,807 S *	4/2006	Choi et al.	.....	D14/138
D536,320 S *	2/2007	Michaels	.....	D14/138
D543,172 S *	5/2007	Lee et al.	.....	D14/138
D543,184 S *	5/2007	Moon et al.	.....	D14/138
D543,185 S *	5/2007	Moon et al.	.....	D14/138
D543,525 S *	5/2007	Kim et al.	.....	D14/138
D543,965 S *	6/2007	Lee et al.	.....	D14/138

D546,307 S *	7/2007	Lee	.....	D14/138
2003/0092401 A1 *	5/2003	Ikeuchi	.....	455/90
2004/0185923 A1 *	9/2004	Park et al.	.....	455/575.1
2005/0282595 A1 *	12/2005	Spence et al.	.....	455/575.3
2006/0135225 A1 *	6/2006	Lin et al.	.....	455/575.3
2007/0026909 A1 *	2/2007	Jung et al.	.....	455/575.3

**OTHER PUBLICATIONS**

Samsung P900 telephone, announced Feb. 2006, [online], [retrieved on Jul. 19, 2007]. Retrieved from Internet , <URL: <http://www.gsmarena.com>>.\*

Samsung U300 telephone, announced Feb. 2007, [online], [retrieved on Jul. 19, 2007]. Retrieved from Internet , <URL: <http://www.gsmarena.com>>.\*

NEC e636 telephone, announced Feb. 2006, [online], [retrieved on Jul. 19, 2007]. Retrieved from Internet , <URL: <http://www.gsmarena.com>>.\*

Philips 580 telephone, announced Dec. 2006, [online], [retrieved on Jul. 19, 2007]. Retrieved from Internet , <URL: <http://www.gsmarena.com>>.\*

\* cited by examiner

*Primary Examiner*—Jeffrey Asch  
(74) *Attorney, Agent, or Firm*—Staas & Halsey LLP

(57) **CLAIM**

The ornamental design for the mobile phone, as shown and described.

**DESCRIPTION**

FIG. 1 is a perspective view of the mobile phone showing our design;

FIG. 2 is a front view thereof;

FIG. 3 is a rear view thereof;

FIG. 4 is a left side view thereof;

FIG. 5 is a right side view thereof;

FIG. 6 is a top plan view thereof;

FIG. 7 is a bottom plan view thereof; and,

FIG. 8 is a perspective, open view thereof.

**1 Claim, 4 Drawing Sheets**

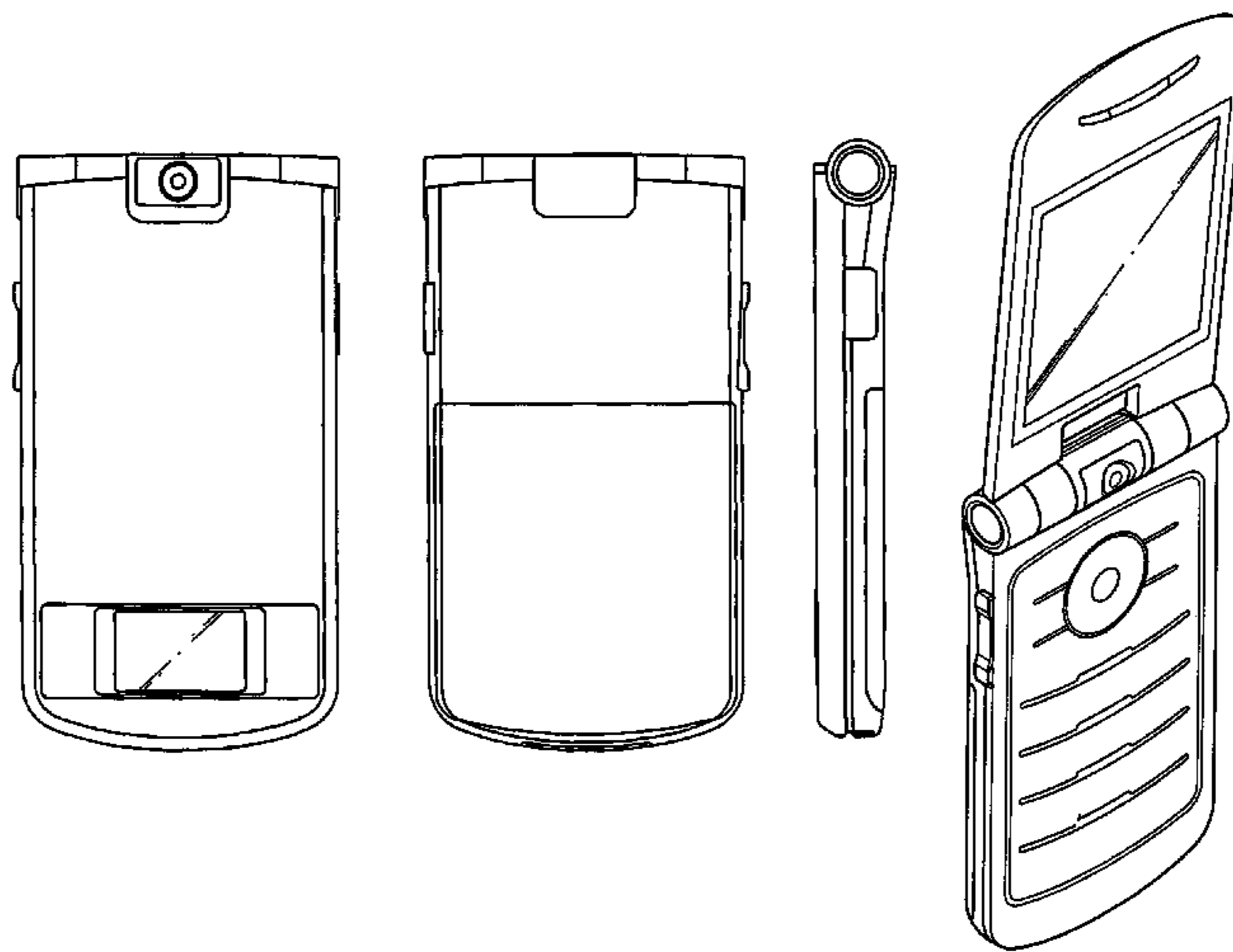

# FIG. 1

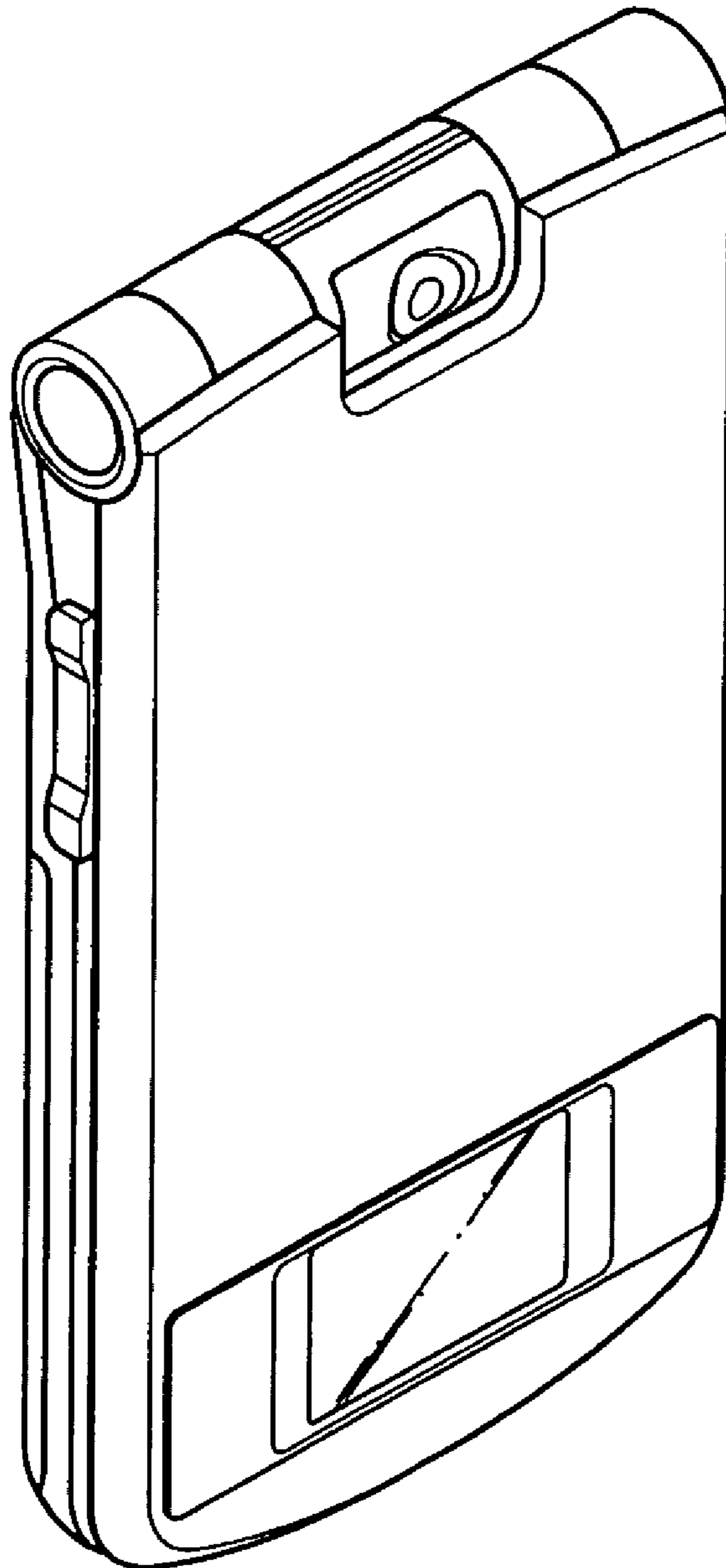

FIG. 2

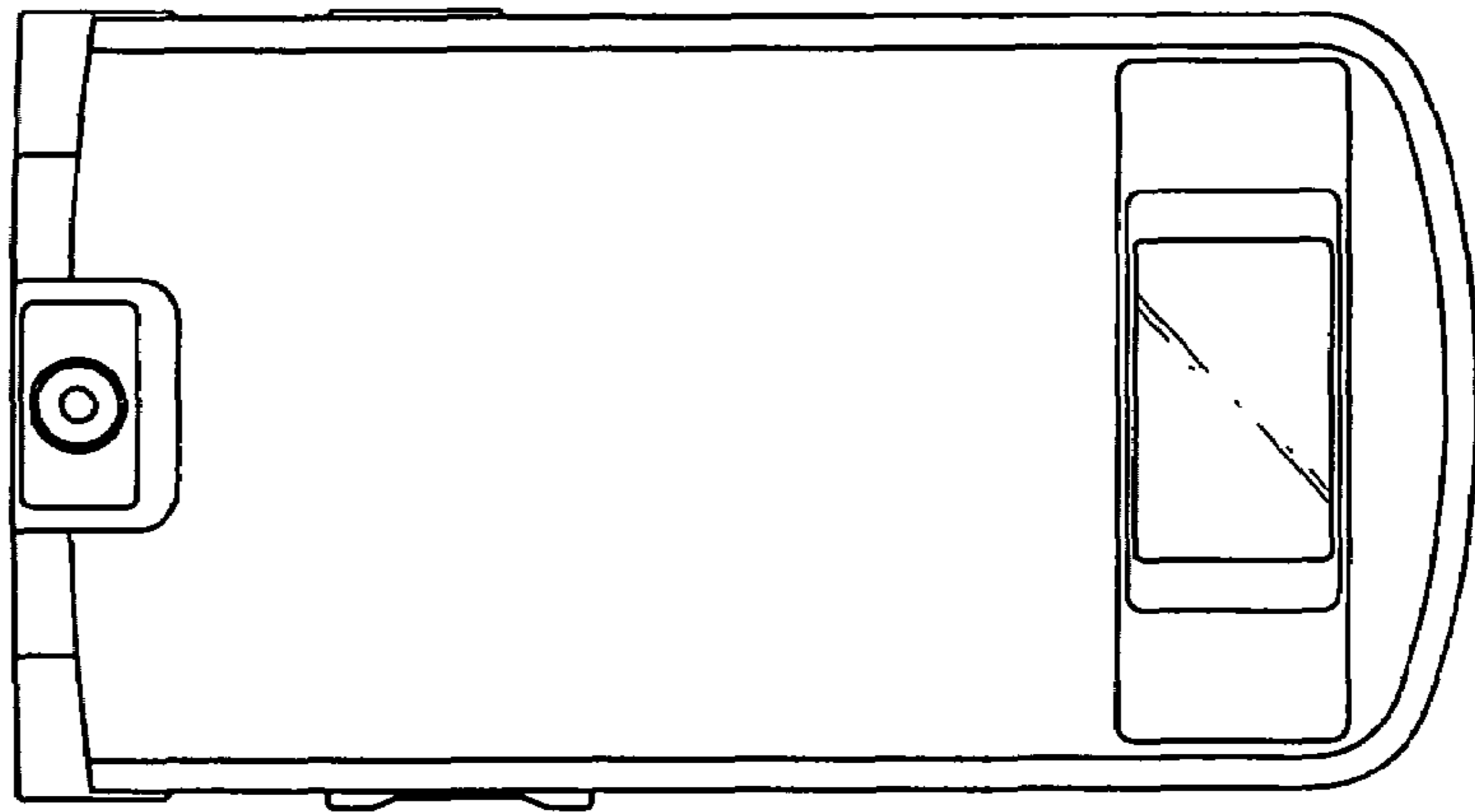

FIG. 3

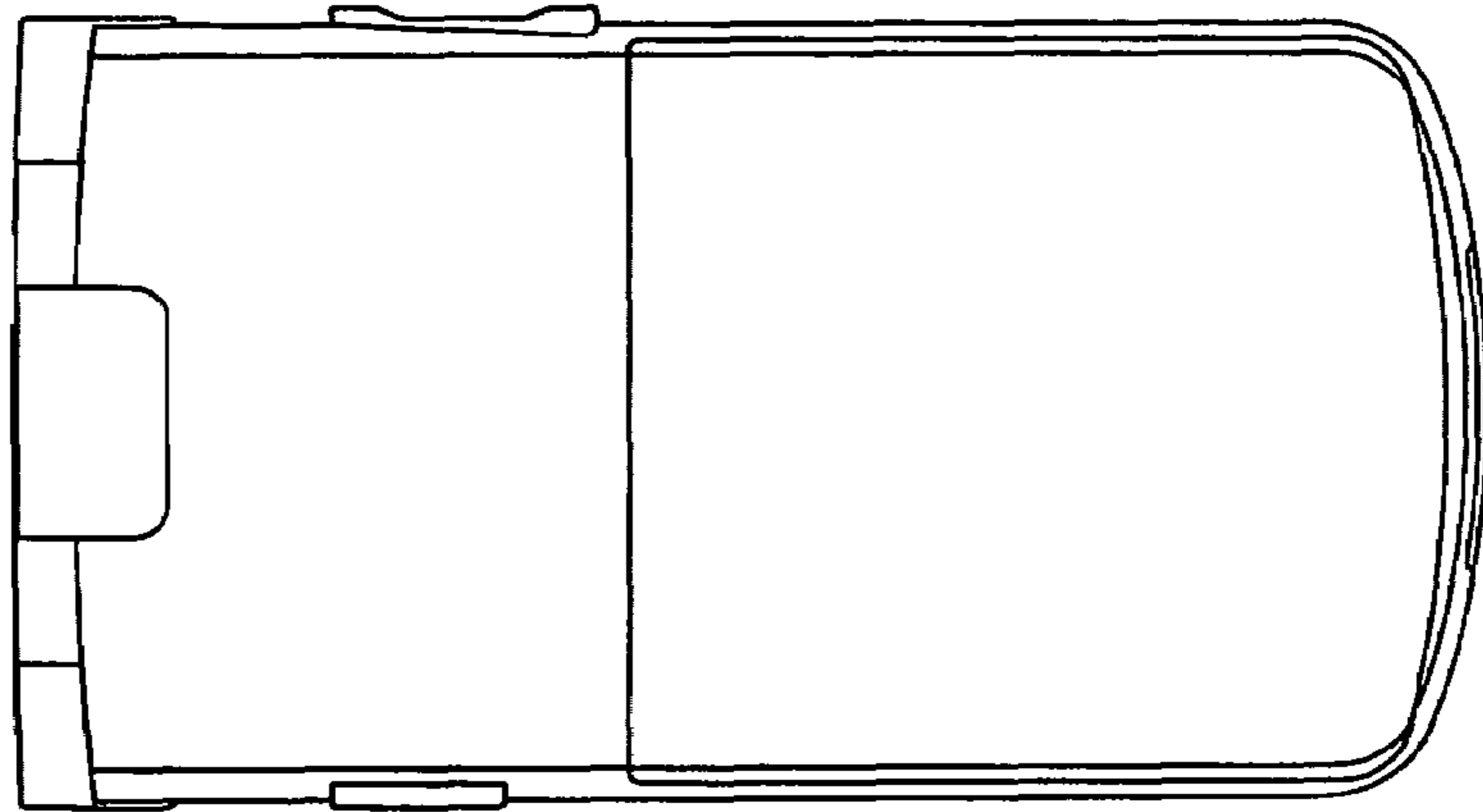

FIG. 4

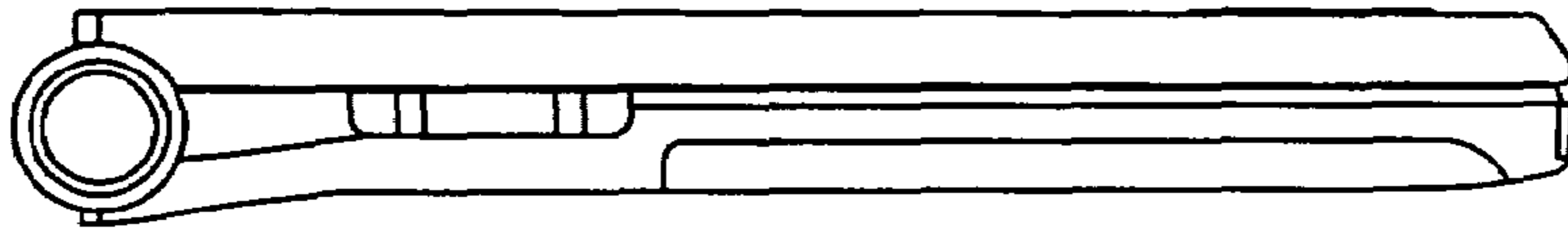

FIG. 5

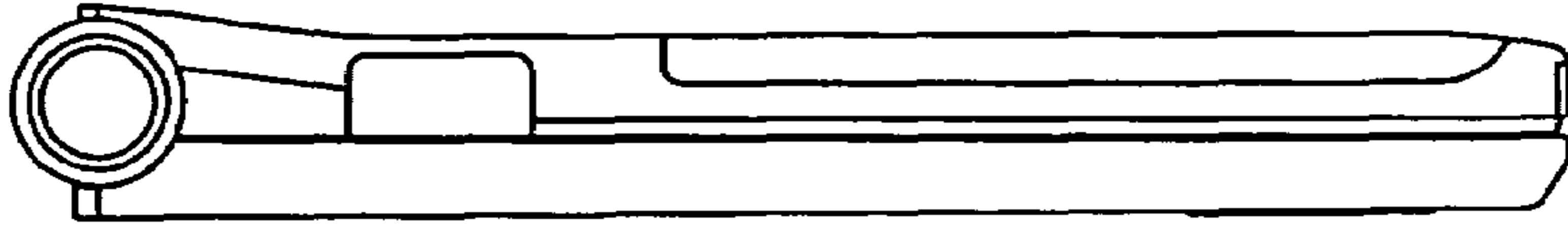

FIG. 6

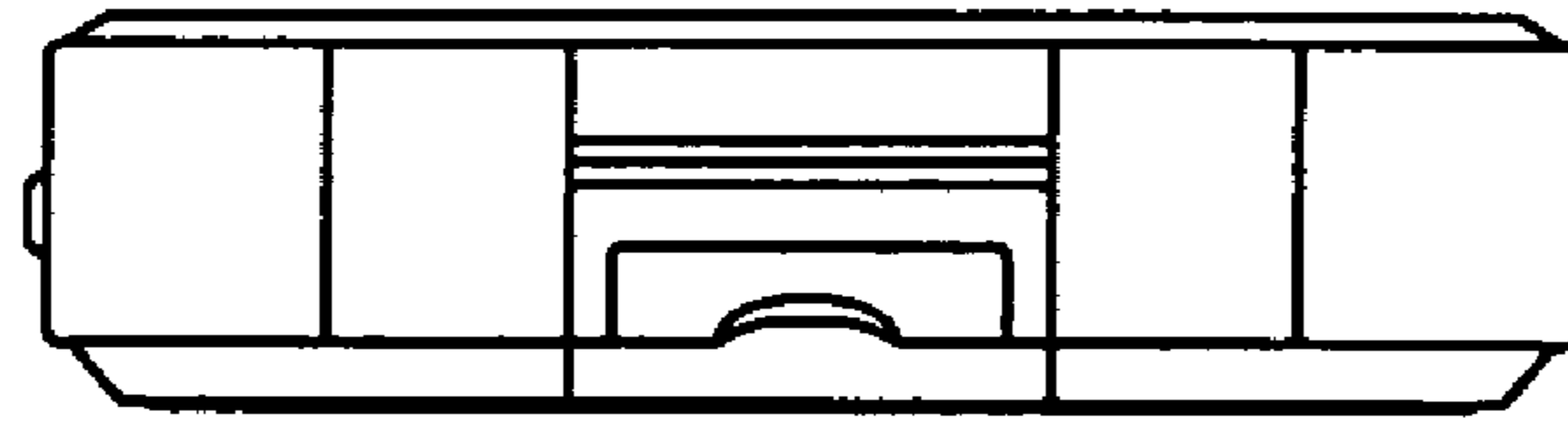

FIG. 7

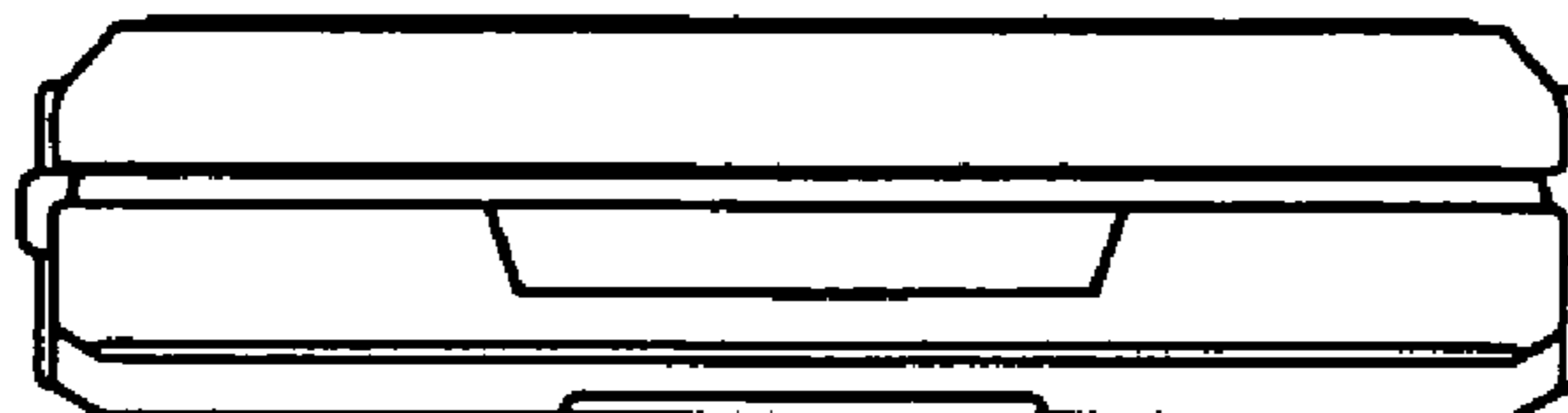

FIG. 8

