



US00D559214S

(12) **United States Design Patent**
Salmi

(10) **Patent No.:** **US D559,214 S**
(45) **Date of Patent:** **** Jan. 8, 2008**

(54) **HANDSET**

(75) Inventor: **Pertti Salmi**, Oulu (FI)

(73) Assignee: **Nokia Corporation**, Espoo (FI)

(**) Term: **14 Years**

(21) Appl. No.: **29/247,688**

(22) Filed: **Jun. 30, 2006**

(30) **Foreign Application Priority Data**

Jan. 5, 2006 (FI) M20060007

(51) **LOC (8) Cl.** **14-03**

(52) **U.S. Cl.** **D14/138**

(58) **Field of Classification Search** D14/137,
D14/138, 147, 218, 247-248, 341-347, 496;
455/90.3, 556.1, 556.2, 575.1, 575.3, 575.4;
379/433.01-433.13; 361/814; 348/14.02
See application file for complete search history.

(56) **References Cited**

U.S. PATENT DOCUMENTS

D481,697 S * 11/2003 Rausch et al. D14/138

(Continued)

FOREIGN PATENT DOCUMENTS

WO DM/ 066 630 6/2005

WO DM/068074 * 7/2006

OTHER PUBLICATIONS

Nokia 6103, announced 1st quarter 2006, [online], [retrieved on Jul. 5, 2007]. Retrieved from Internet, <URL: <http://www.gsmarena.com>>.*

Nokia 6125, announced 1st quarter 2006, [online], [retrieved on Jul. 5, 2007]. Retrieved from Internet, <URL: <http://www.gsmarena.com>>.*

(Continued)

Primary Examiner—Jeffrey Asch
Assistant Examiner—Bridget L Eland

(74) *Attorney, Agent, or Firm*—Banner & Witcoff, Ltd.

(57) **CLAIM**

The ornamental design for a handset, as shown and described.

DESCRIPTION

FIG. 1 is a bottom plan view of a handset showing my new design;

FIG. 2 is a right side view thereof;

FIG. 3 is a front view thereof;

FIG. 4 is a left side view thereof;

FIG. 5 is a top plan view thereof;

FIG. 6 is a rear view thereof;

FIG. 7 is a perspective front view thereof;

FIG. 8 is a perspective rear view thereof;

FIG. 9 is a front view of the handset of FIGS. 1-8 in an in-use open position;

FIG. 10 is a perspective front view of the handset of FIGS. 1-8 in an in-use open position;

FIG. 11 is a perspective rear view of the handset of FIGS. 1-8 in an in-use open position;

FIG. 12 is a rear view of the handset of FIGS. 1-8 in an in-use open position;

FIG. 13 is a right side view of the handset of FIGS. 1-8 in an in-use open position; and,

FIG. 14 is a left side view of the handset of FIGS. 1-8 in an in-use position.

The generally rectangular-shaped region disposed generally centrally on the handset in FIGS. 3, 7, 11, and 12 represents a screen display and the generally square-shaped region disposed above the generally rectangular-shaped region shown in FIGS. 3, 7, 11 and 12 represents a camera. The broken line showing environmental structures of the handset is for illustrative purposes only and form no part of the claimed design.

1 Claim, 9 Drawing Sheets

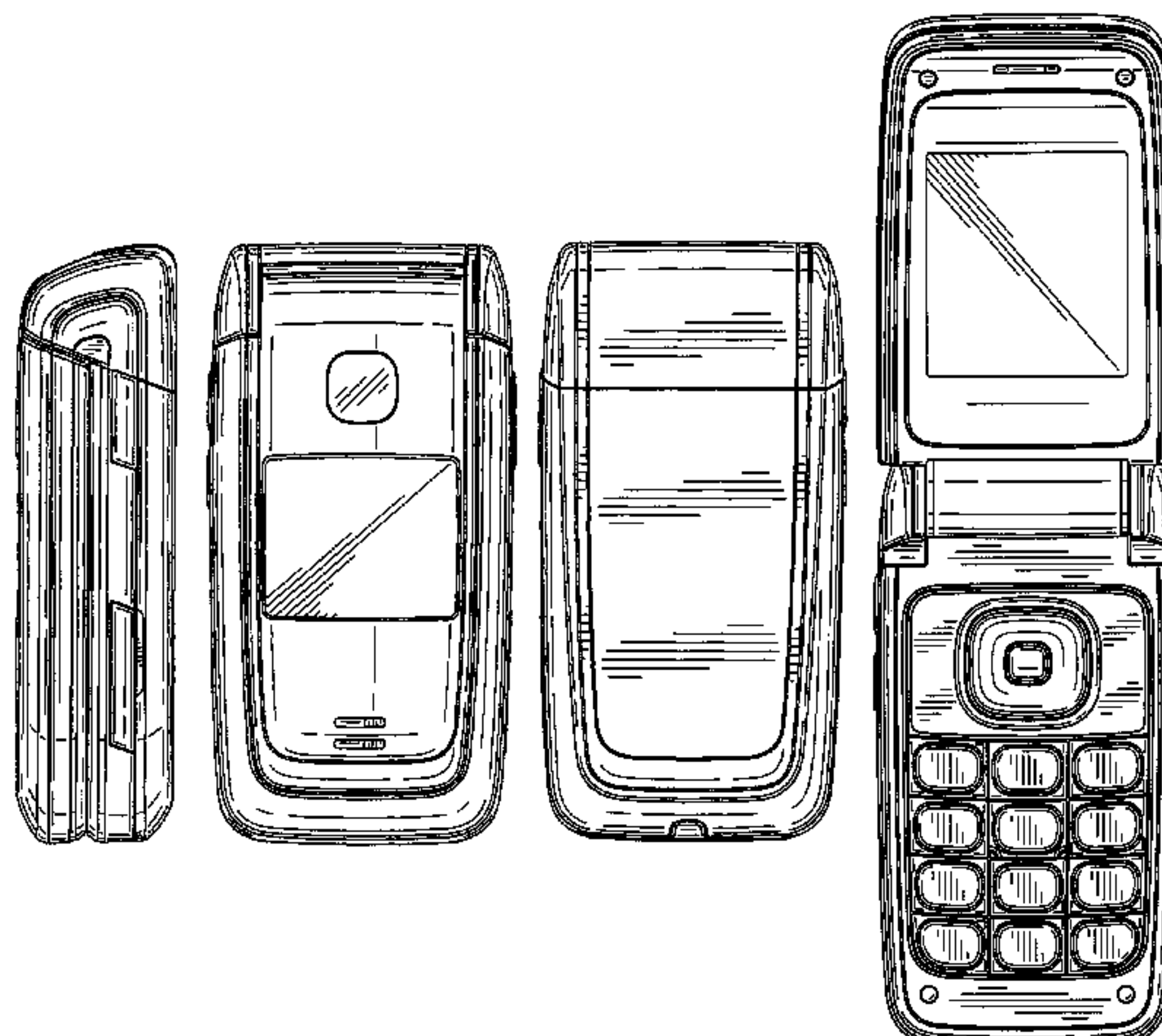

US D559,214 S

Page 2

U.S. PATENT DOCUMENTS

D496,016 S * 9/2004 Hoo D14/138
D500,016 S * 12/2004 Kim D14/138
D501,839 S * 2/2005 Lee et al. D14/138
D502,161 S * 2/2005 Kim et al. D14/138
D510,733 S * 10/2005 Lee et al. D14/138
D512,038 S * 11/2005 Kim et al. D14/138
D512,039 S * 11/2005 Kim et al. D14/138
D512,394 S * 12/2005 Kim et al. D14/138
D518,465 S * 4/2006 Van Den Nieuwenhuizen
et al. D14/138
D519,098 S * 4/2006 Han et al. D14/138
D519,479 S * 4/2006 Koo et al. D14/318
D520,483 S * 5/2006 Park et al. D14/138
D520,484 S * 5/2006 Lee et al. D14/138
D520,981 S * 5/2006 Lee et al. D14/138
D521,478 S * 5/2006 Lee et al. D14/138
D521,970 S * 5/2006 Han et al. D14/138
D523,411 S * 6/2006 Kim et al. D14/138
D536,322 S * 2/2007 Kim et al. D14/138
D536,698 S * 2/2007 Fahlgren D14/247
D537,428 S * 2/2007 Fahlgren D14/138

D537,429 S * 2/2007 Fahlgren D14/138
7,173,665 B2 * 2/2007 Kawasaki et al. 348/376
D538,771 S * 3/2007 Bower D14/138
2004/0132513 A1 * 7/2004 Taneda et al. 455/575.3
2006/0063572 A1 * 3/2006 Garcia et al. 455/575.3

OTHER PUBLICATIONS

Nokia 6290, announced Nov. 2006, [online], [retrieved on Jul. 5, 2007]. Retrieved from Internet, <URL: <http://www.gsmarena.com>>.*

Samsung S342i, announced 1st quarter 2005, [online], [retrieved on Jul. 6, 2007]. Retrieved from Internet, <URL: <http://www.gsmarena.com>>.*

Samsung Z300, announced 1st quarter 2005, [online], [retrieved on Jul. 6, 2007]. Retrieved from Internet, <URL: <http://www.gsmarena.com>>.*

Samsung Z230, announced Sep. 2006, [online], [retrieved on Jul. 6, 2007]. Retrieved from Internet, <URL: <http://www.gsmarena.com>>.*

* cited by examiner

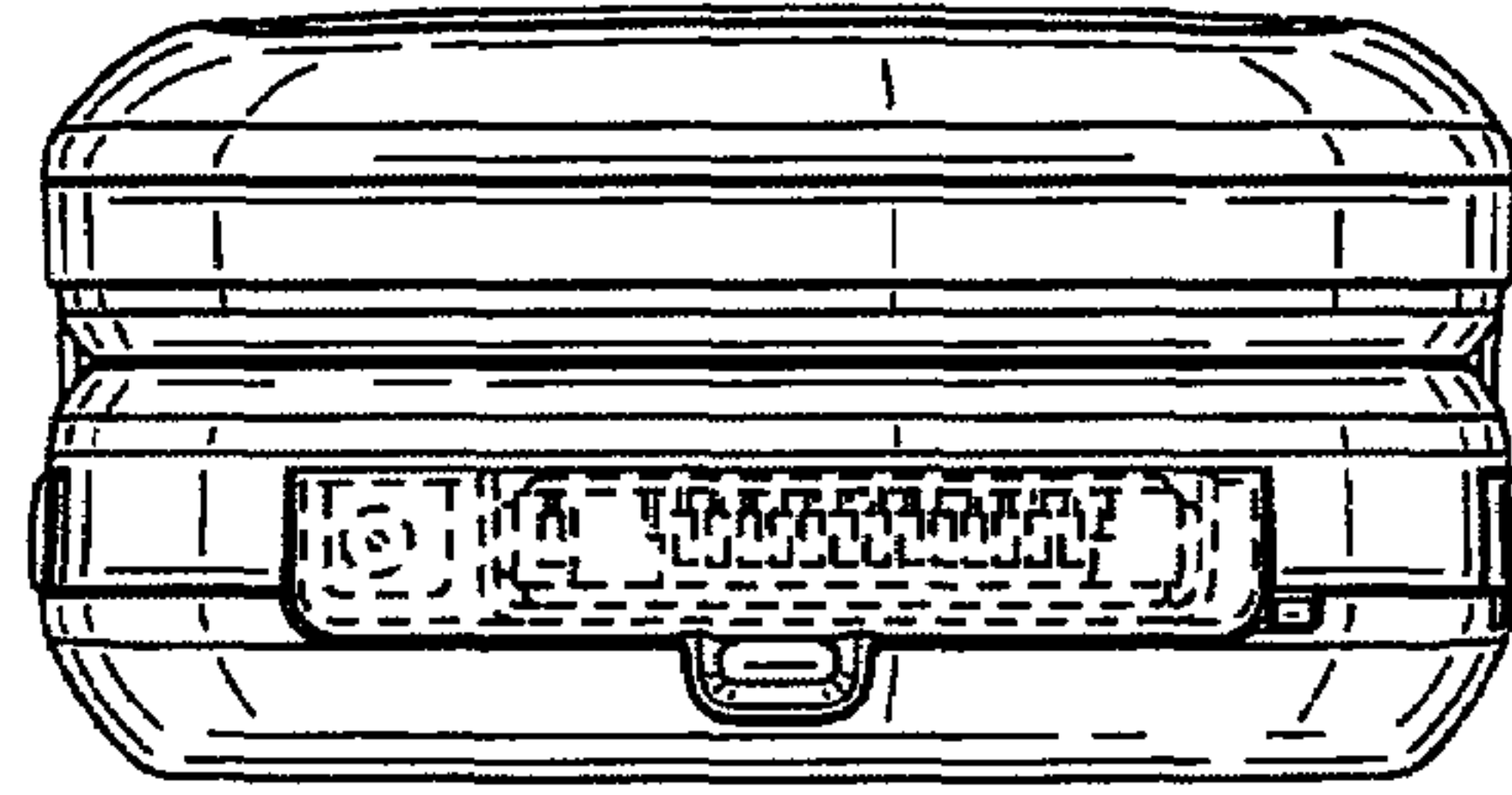

FIG. 1

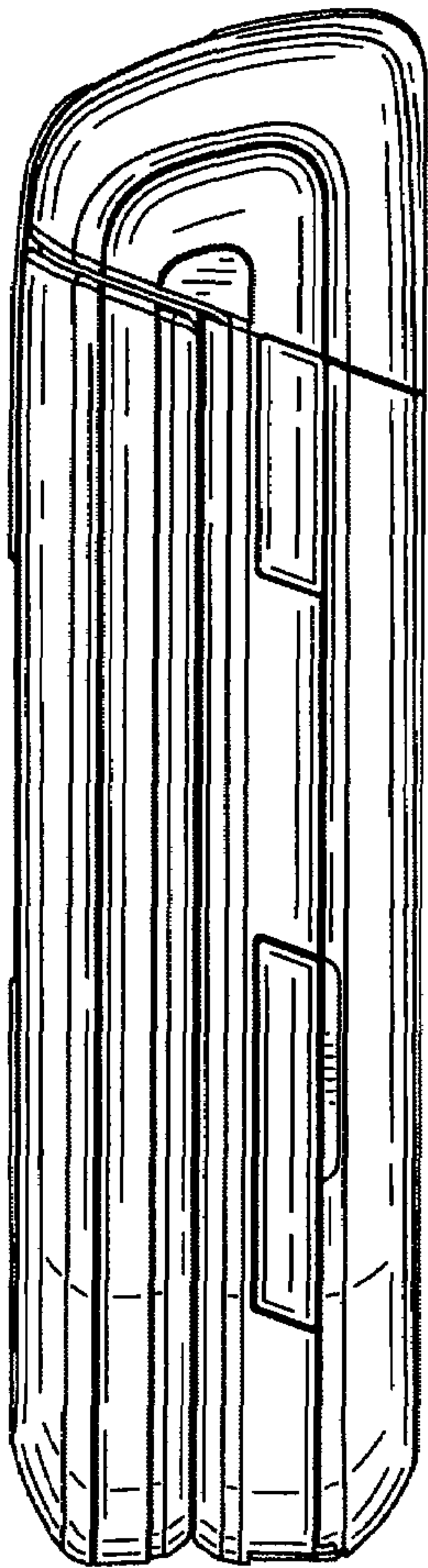

FIG. 2

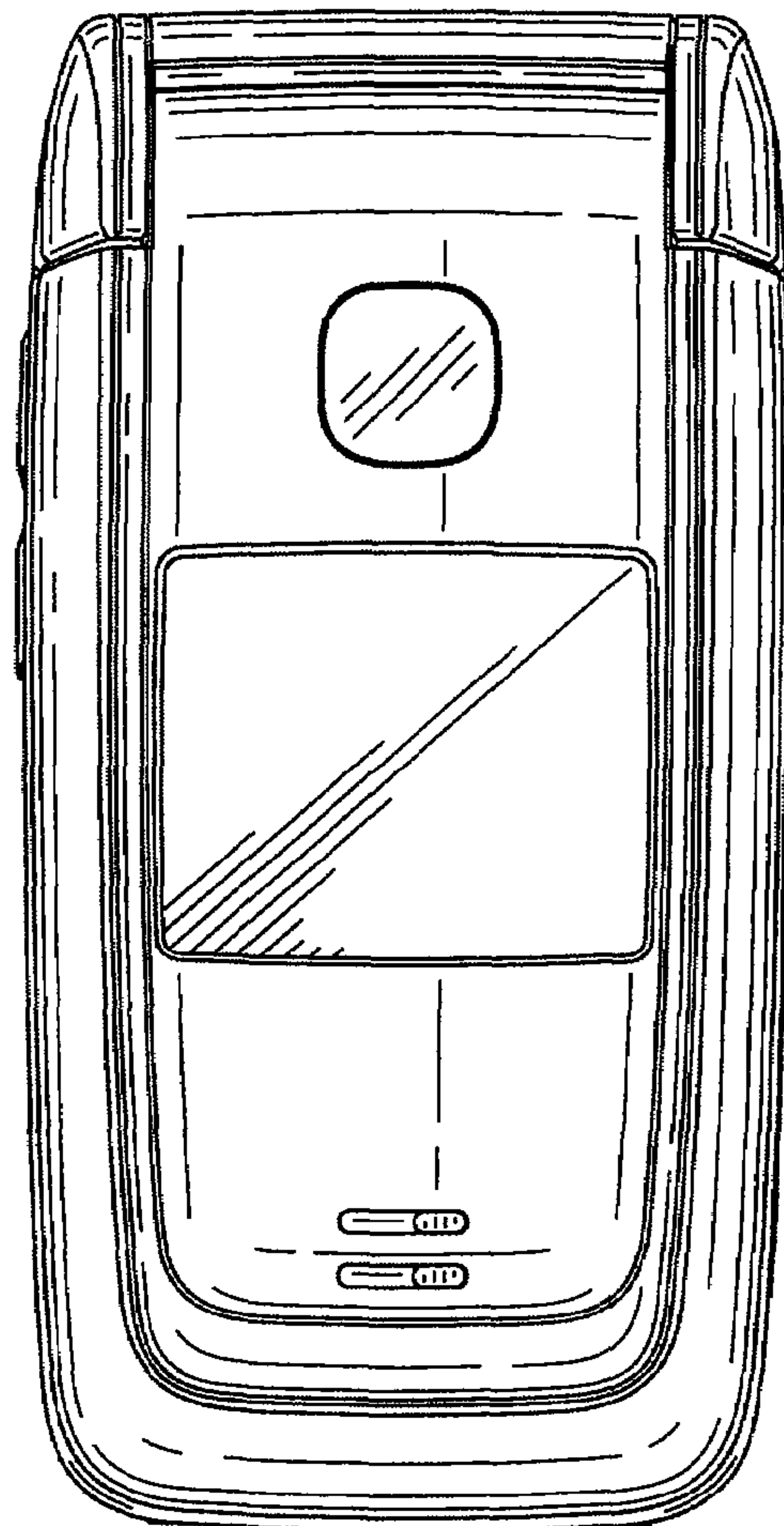

FIG. 3

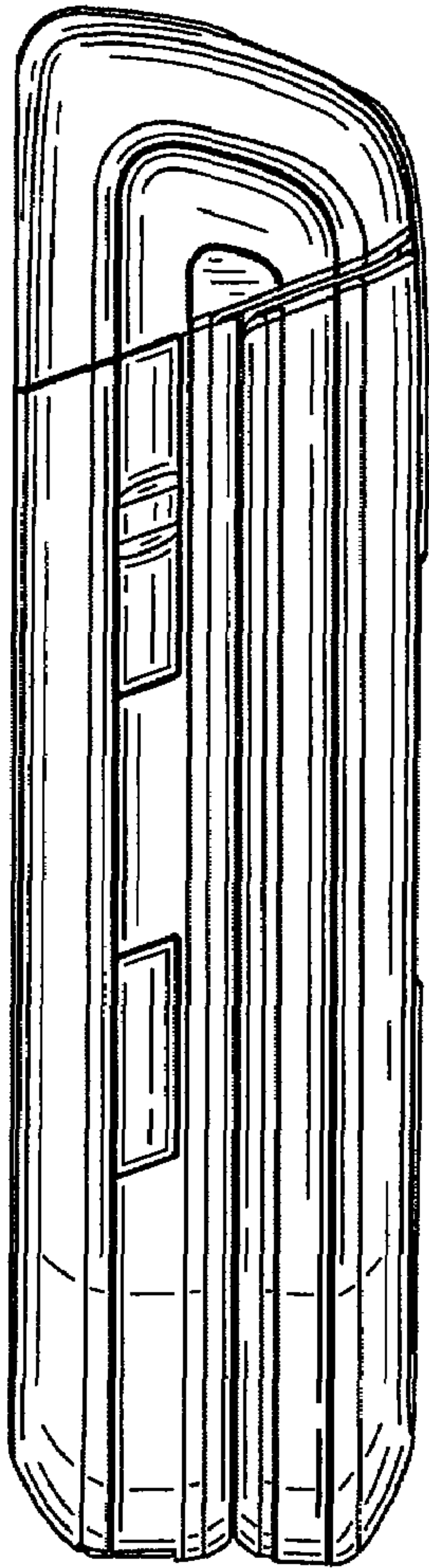

FIG. 4

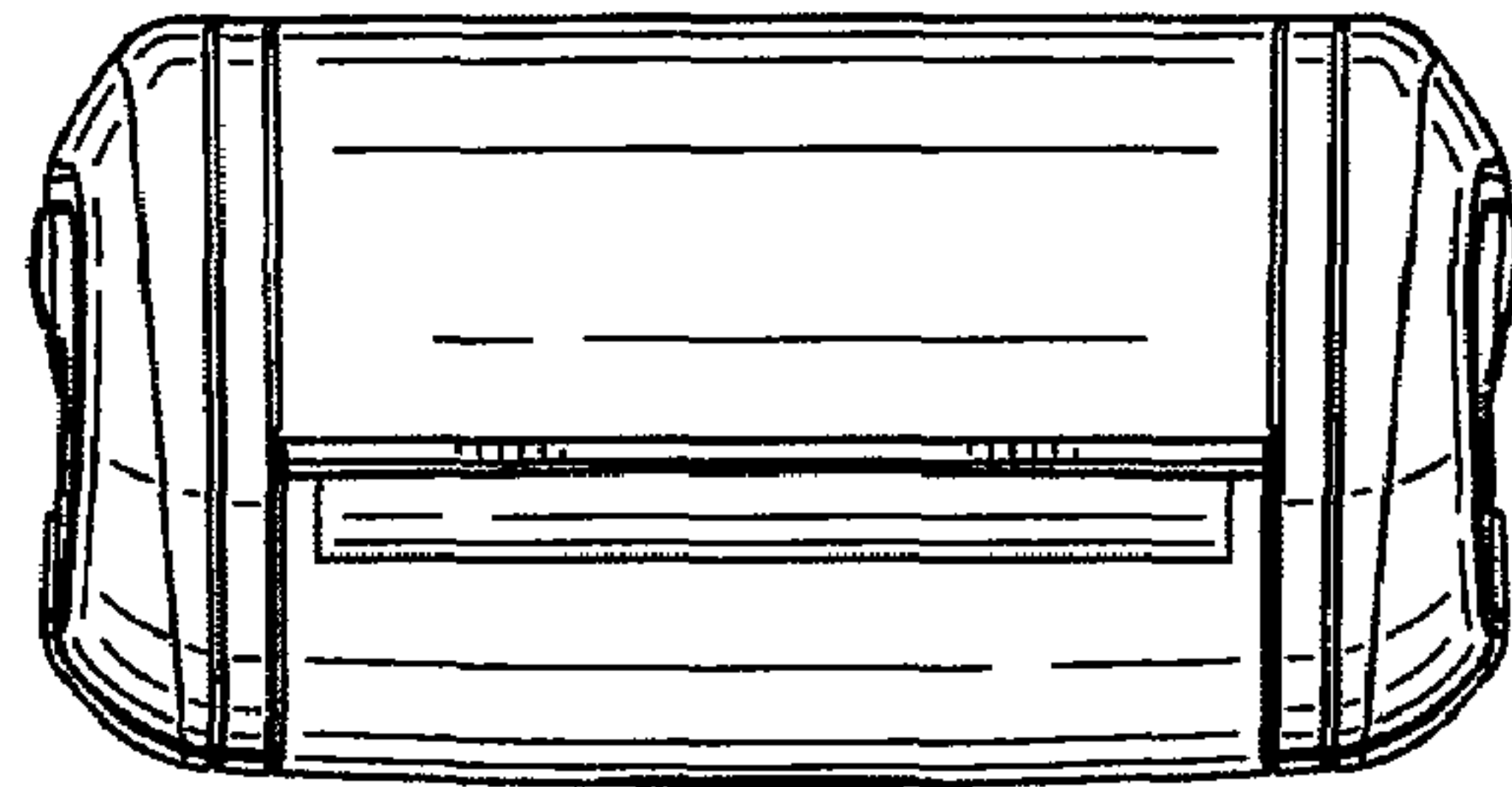

FIG. 5

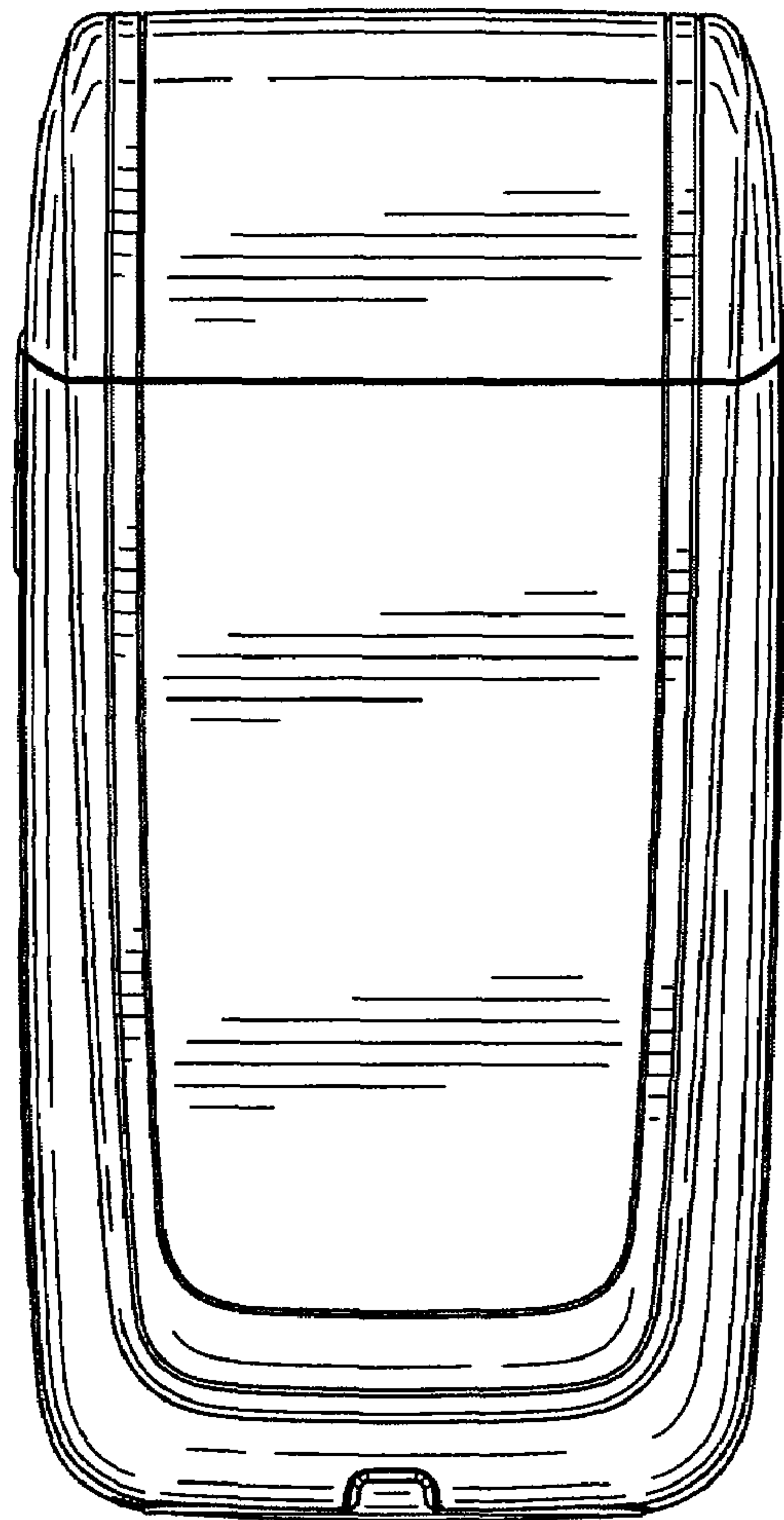

FIG. 6

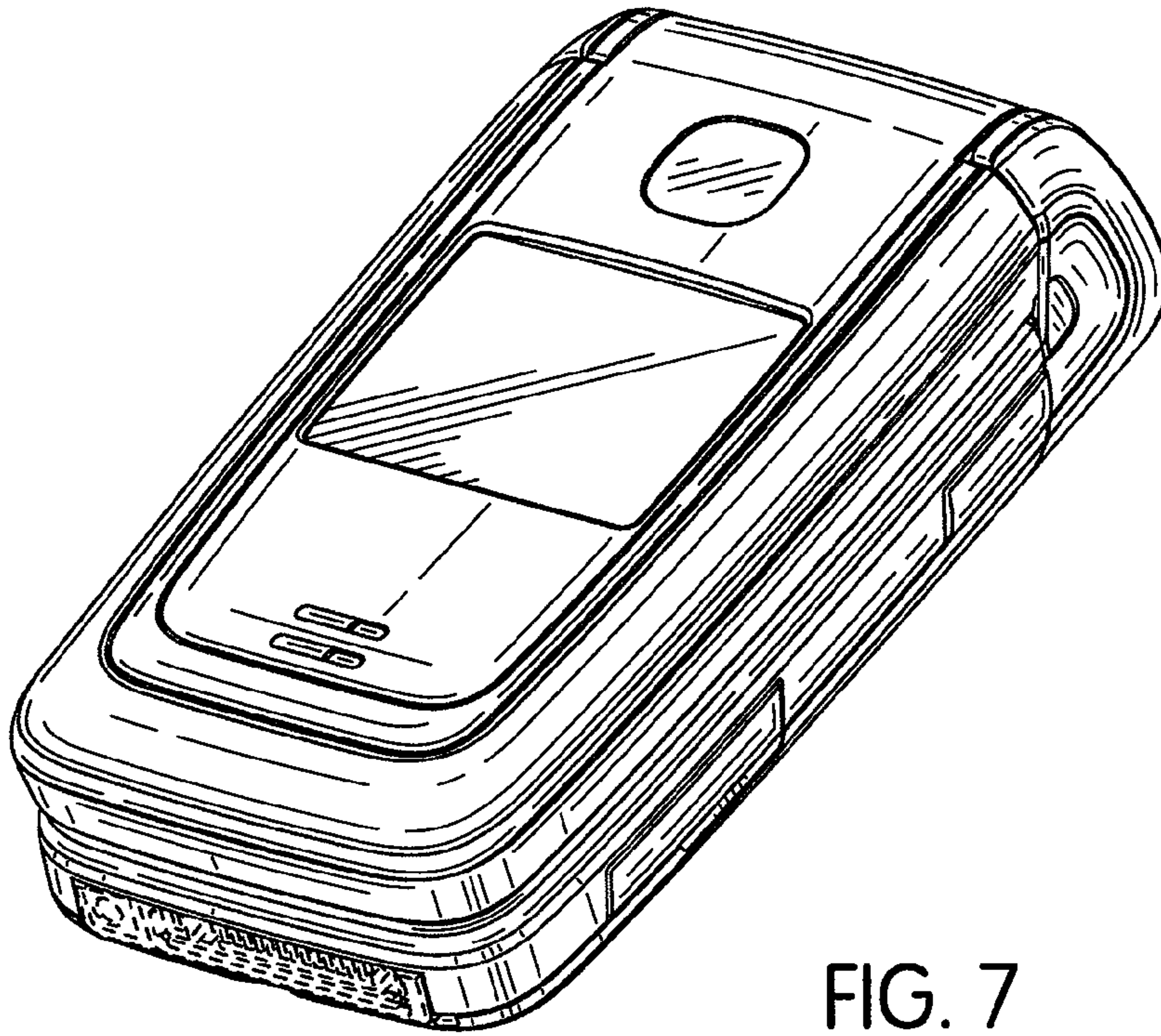

FIG. 7

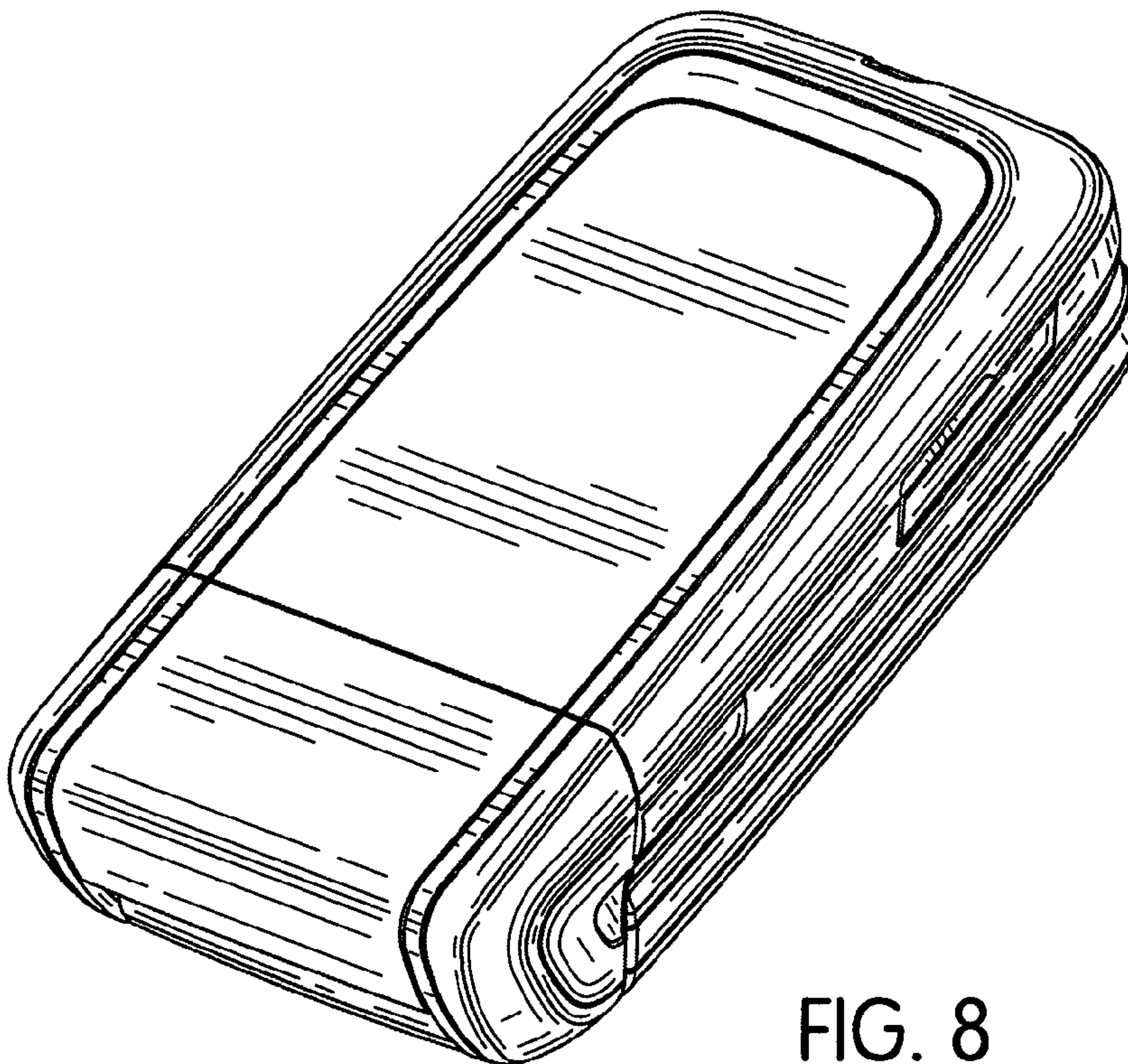

FIG. 8

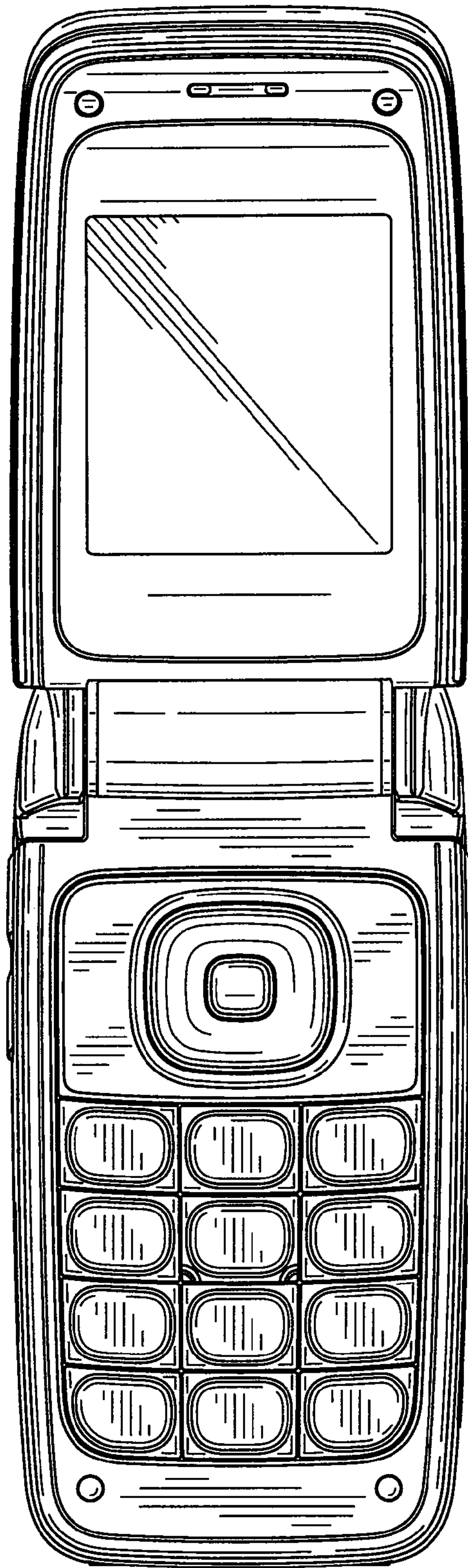

FIG. 9

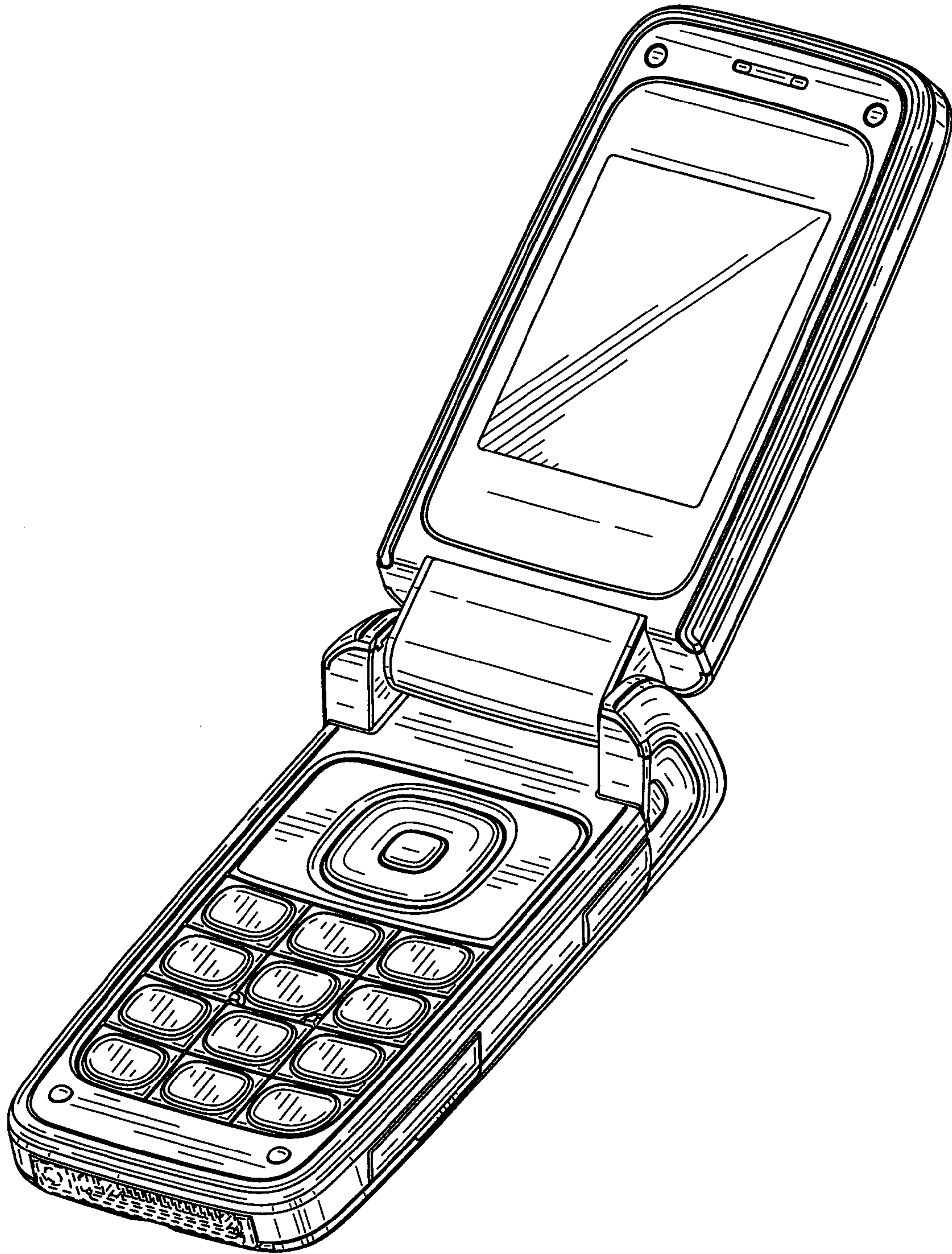

FIG. 10

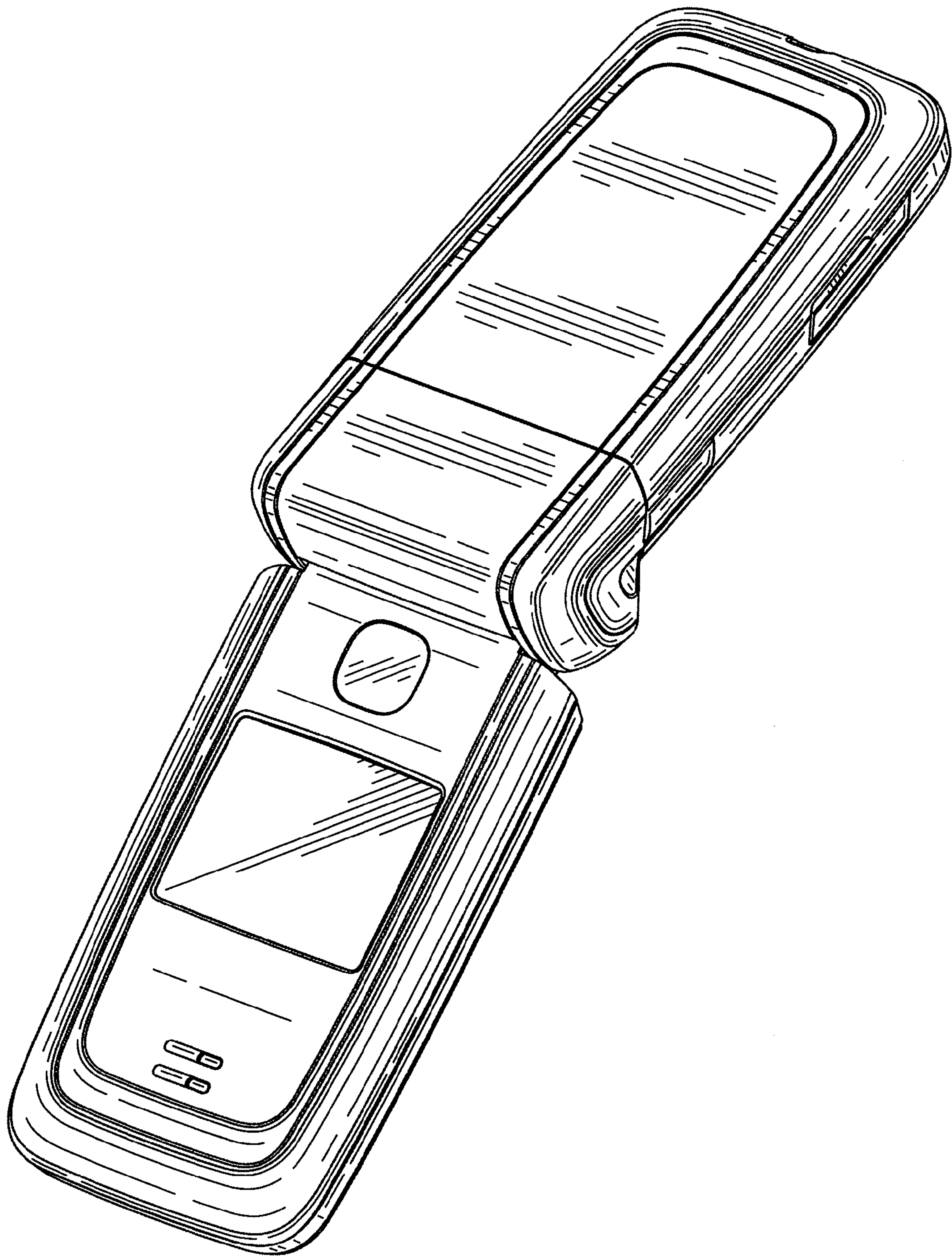

FIG. 11

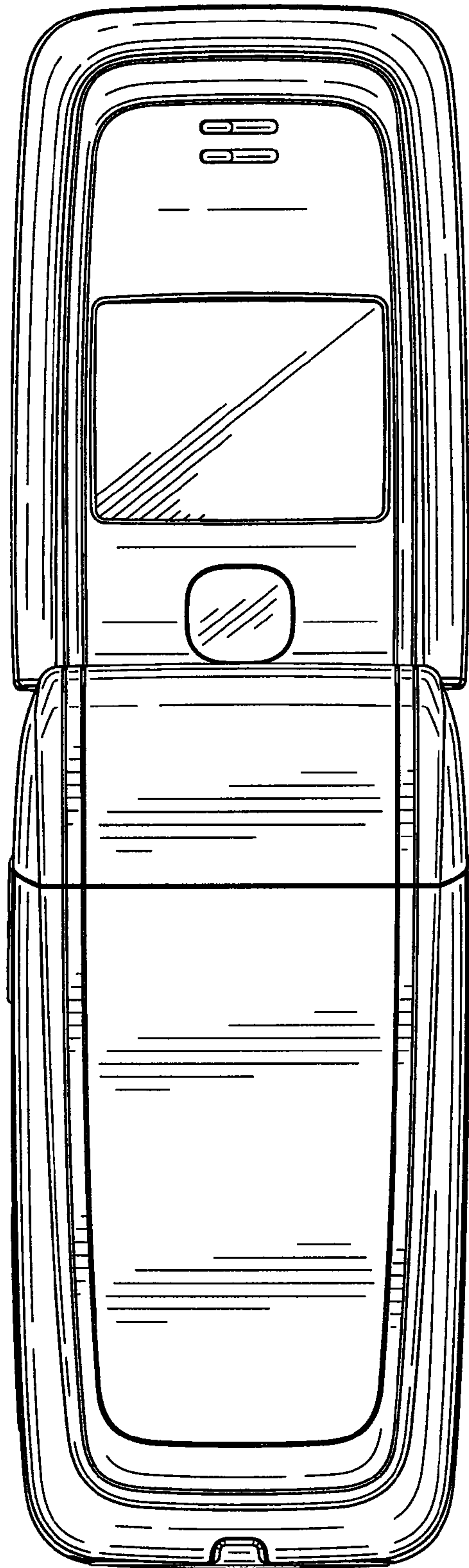

FIG. 12

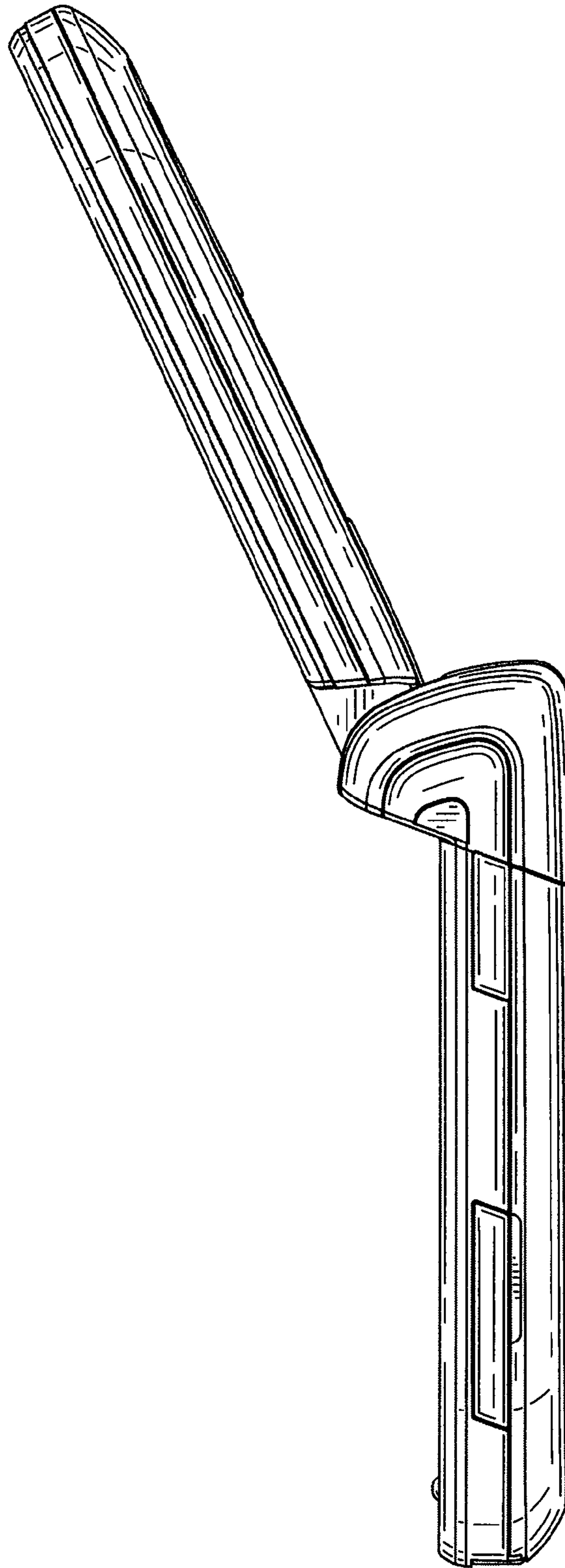

FIG. 13

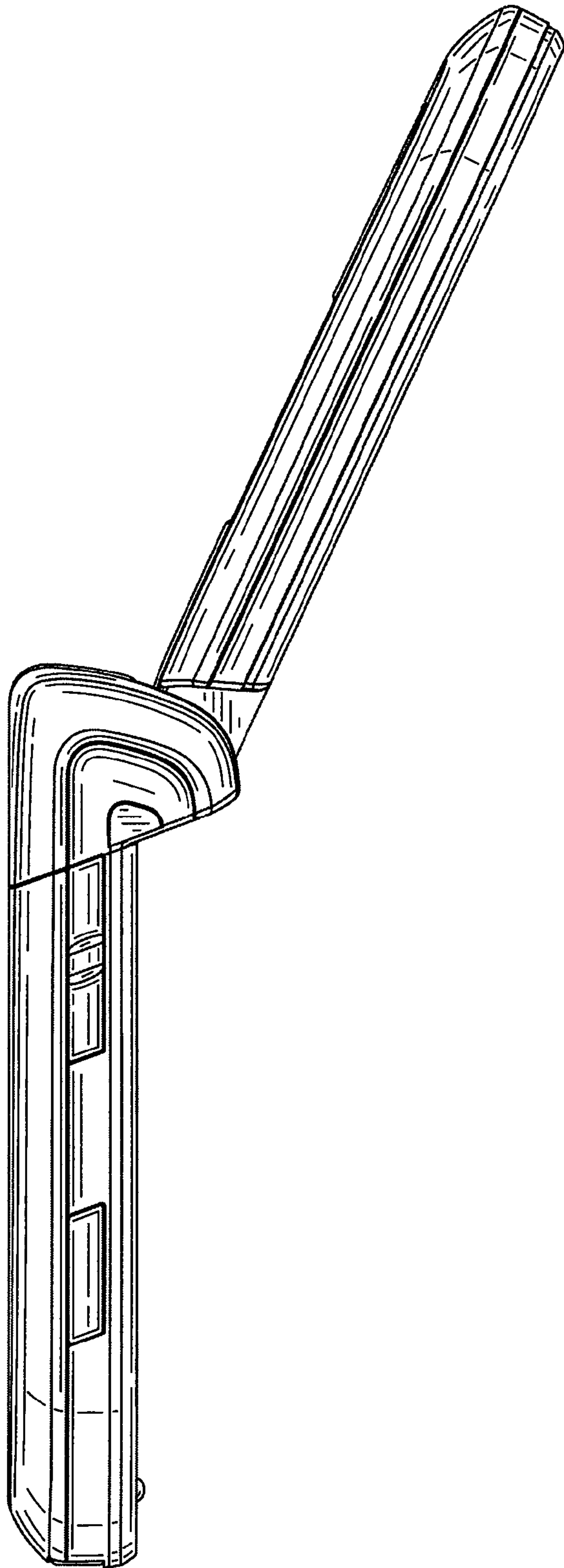

FIG. 14