



US00D559153S

(12) **United States Design Patent** (10) **Patent No.:** **US D559,153 S**
Rabinowitz et al. (45) **Date of Patent:** **** Jan. 8, 2008**

(54) **AUTOMOBILE BODY**

(74) *Attorney, Agent, or Firm*—Ralph E. Smith

(75) Inventors: **Todd M. Rabinowitz**, Farmington, MI (US); **Joseph S. Dehner**, Bloomfield, MI (US); **Mark D. Hall**, Rochester, MI (US)

(57) **CLAIM**

The ornamental design for an automobile body, as shown and described.

(73) Assignee: **Chrysler LLC**, Auburn Hills, MI (US)

DESCRIPTION

(**) Term: **14 Years**

FIG. 1 is a front perspective view of an automobile body showing our new design;

(21) Appl. No.: **29/280,040**

FIG. 2 is a side view thereof;

(22) Filed: **May 15, 2007**

FIG. 3 is a front view thereof;

Related U.S. Application Data

FIG. 4 is a rear view thereof;

(63) Continuation of application No. 29/248,213, filed on Aug. 3, 2006.

FIG. 5 is a rear perspective view thereof;

(51) **LOC (8) Cl.** **12-08**

FIG. 6 is a front perspective view of an automobile body showing a second embodiment of our new design;

(52) **U.S. Cl.** **D12/92**

FIG. 7 is a side view of FIG. 6;

(58) **Field of Classification Search** D12/90–92,
D12/86; 296/181.1, 181.5

FIG. 8 is a front view of FIG. 6;

See application file for complete search history.

FIG. 9 is a rear view of FIG. 6;

(56) **References Cited**

FIG. 10 is a rear perspective view of FIG. 6;

U.S. PATENT DOCUMENTS

FIG. 11 is a front perspective view of an automobile body showing a third embodiment of our new design;

D440,526 S *	4/2001	Dehner et al.	D12/92
D440,527 S *	4/2001	Wagner et al.	D12/92
D455,676 S *	4/2002	Stoddard et al.	D12/92
D490,023 S *	5/2004	Howell et al.	D12/92
D500,000 S *	12/2004	Dyson et al.	D12/92
D543,135 S *	5/2007	Trostle et al.	D12/92

FIG. 12 is a side view of FIG. 11;

FIG. 13 is a front view of FIG. 11;

FIG. 14 is a rear view of FIG. 11; and,

FIG. 15 is a rear perspective view of FIG. 11.

* cited by examiner

It will be understood that the broken lines presented in the drawings are for illustration only, and do not form a part of the claimed design.

Primary Examiner—Melody N. Brown

1 Claim, 12 Drawing Sheets

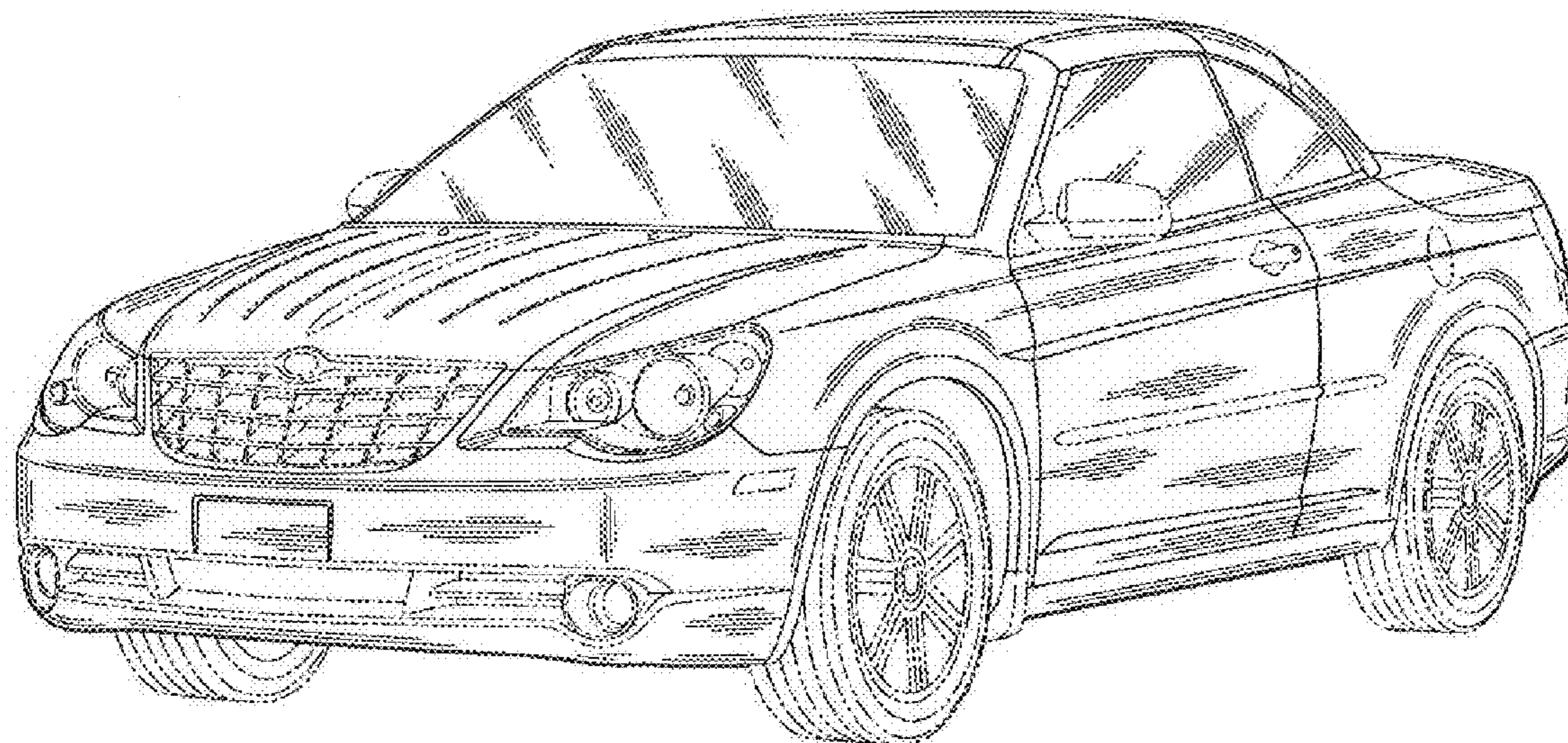

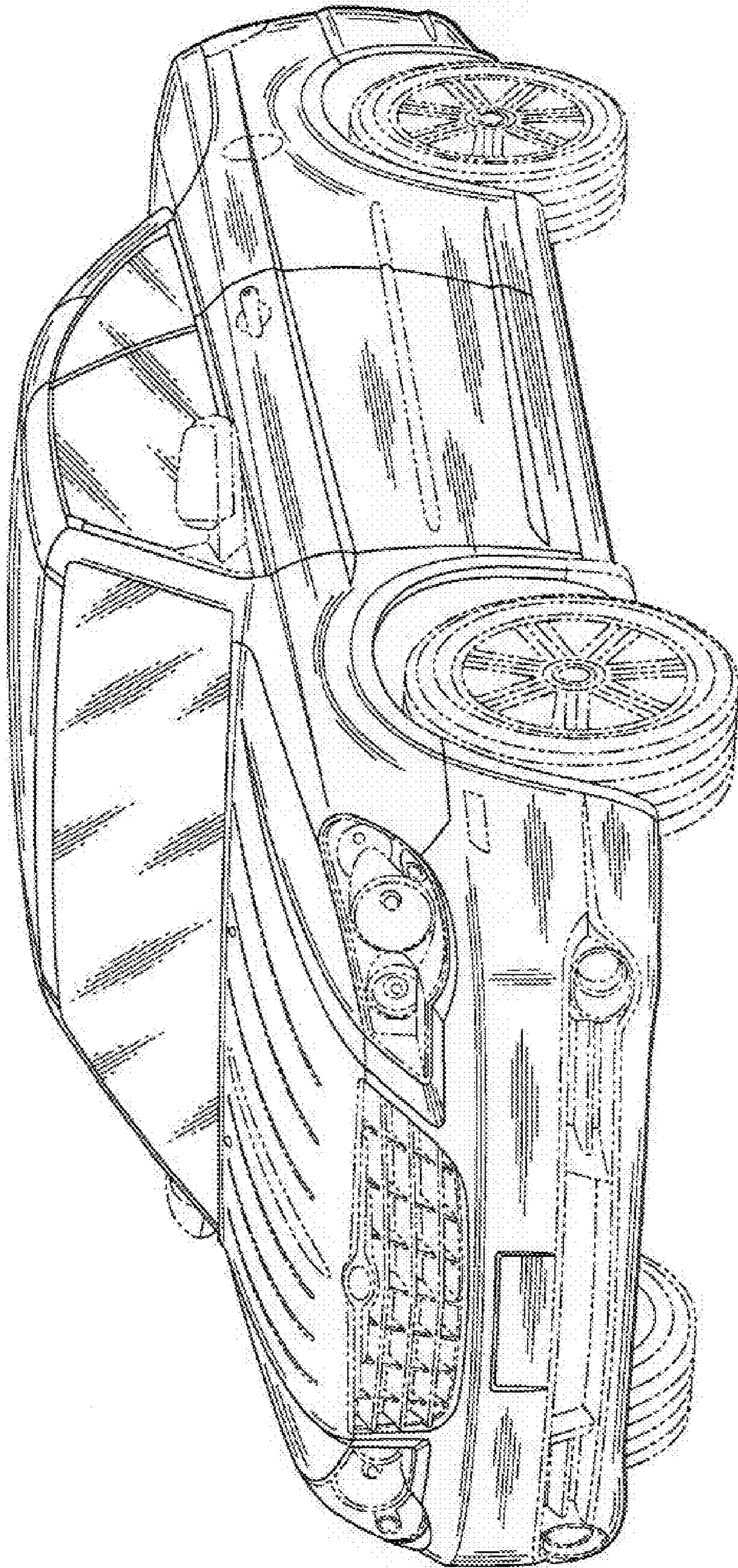

Fig. 1

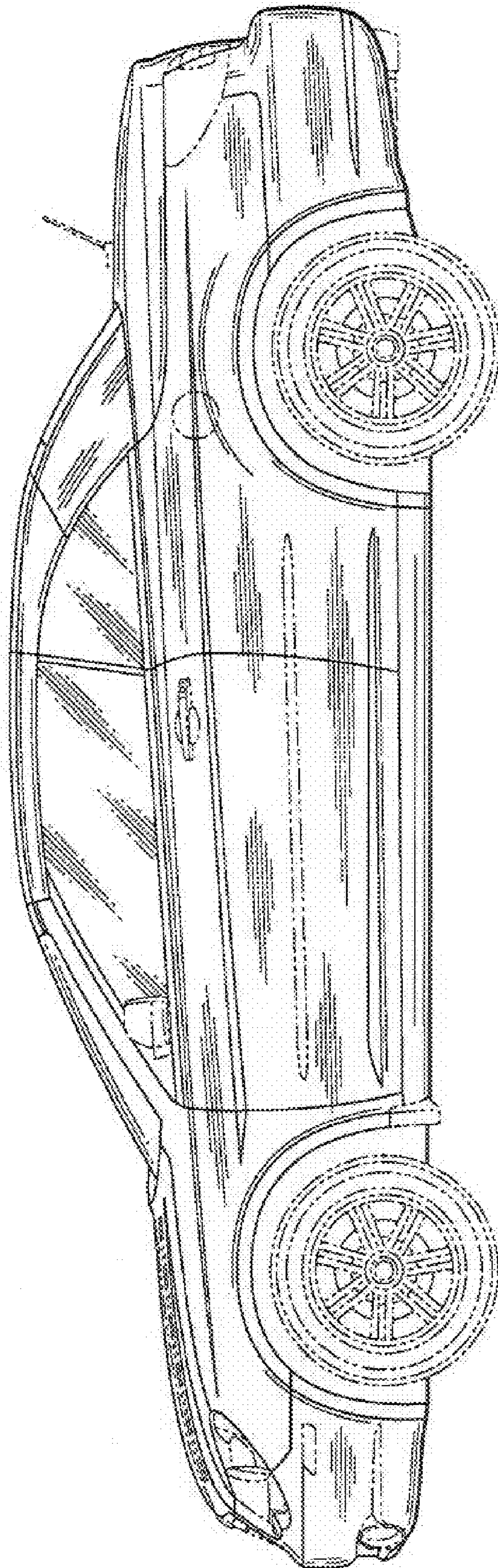

Fig. 2

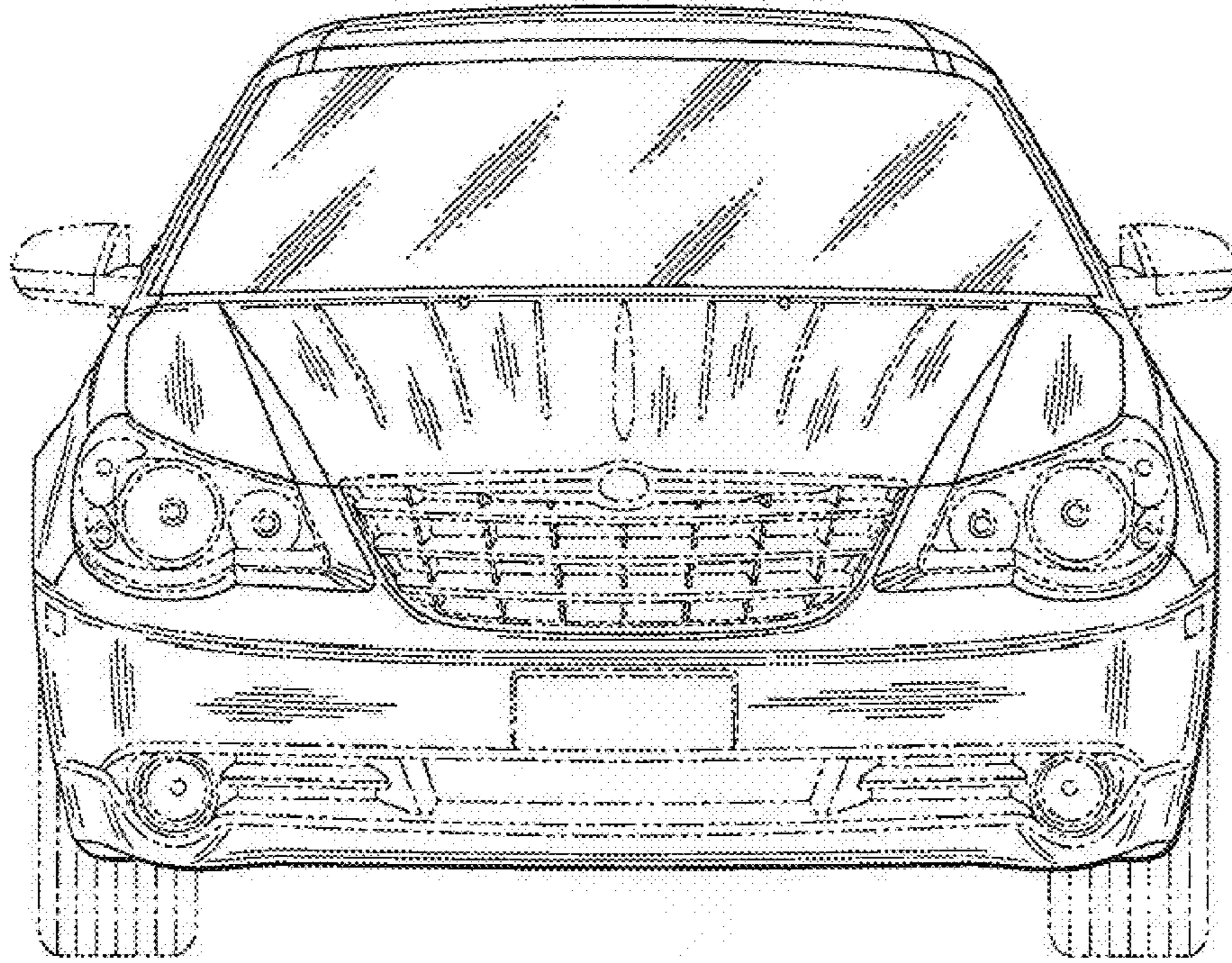

Fig. 3

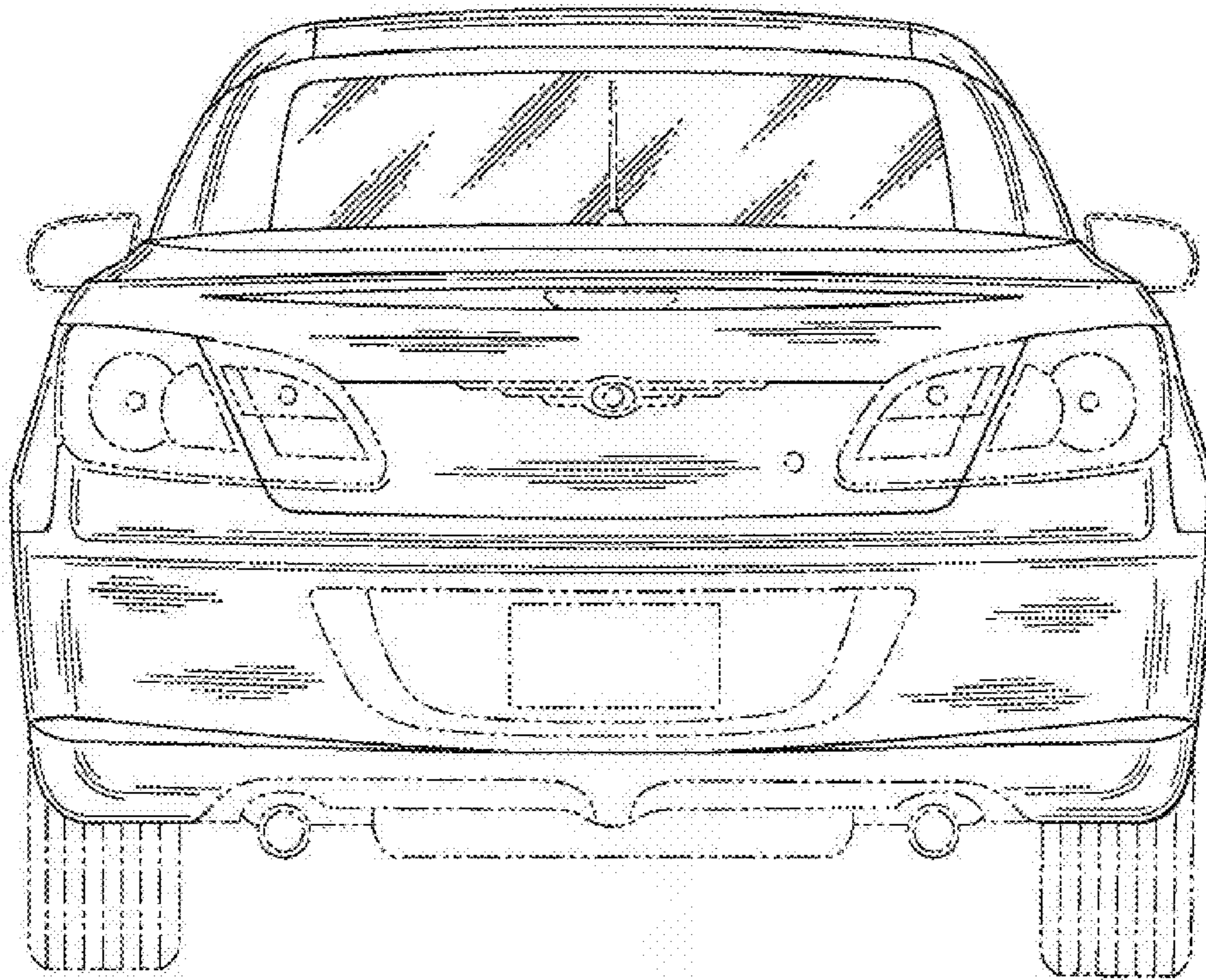

Fig. 4

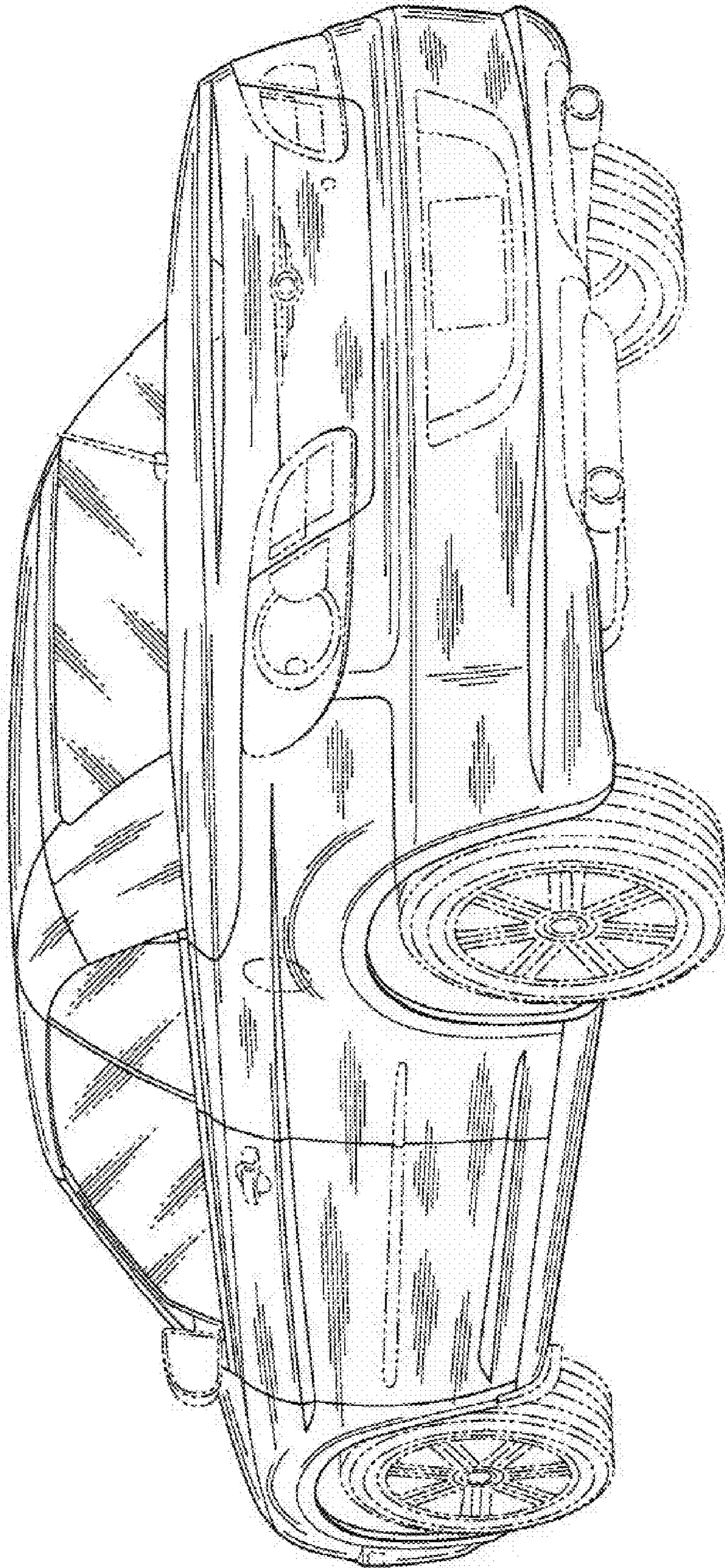

Fig. 5

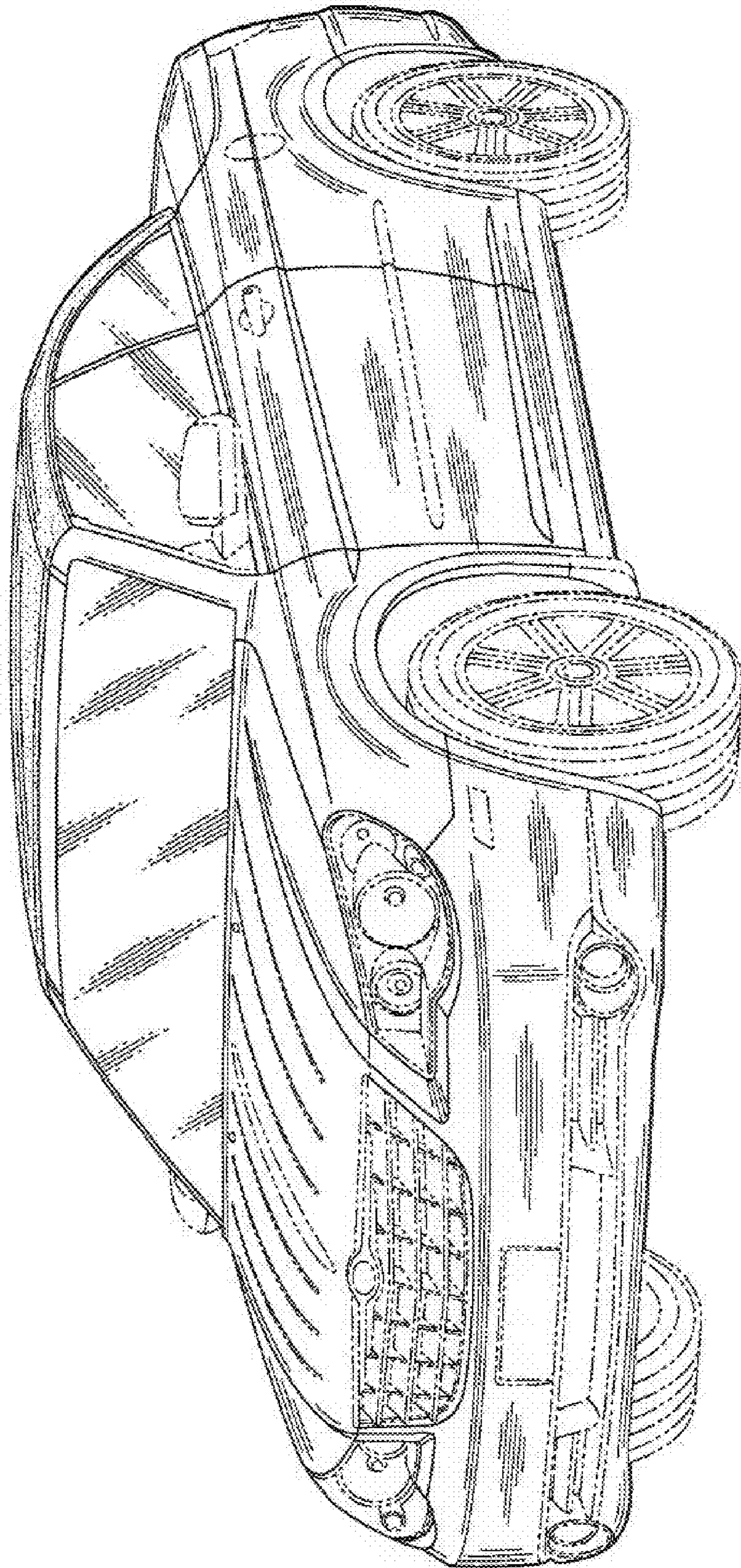

Fig. 6

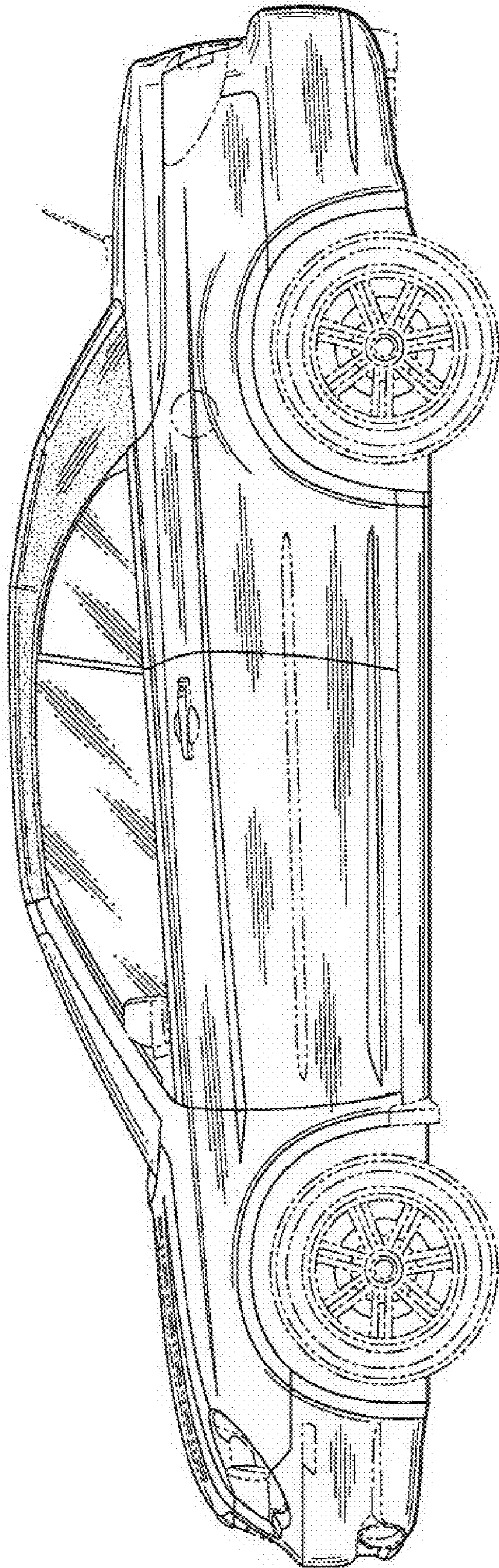

Fig. 7

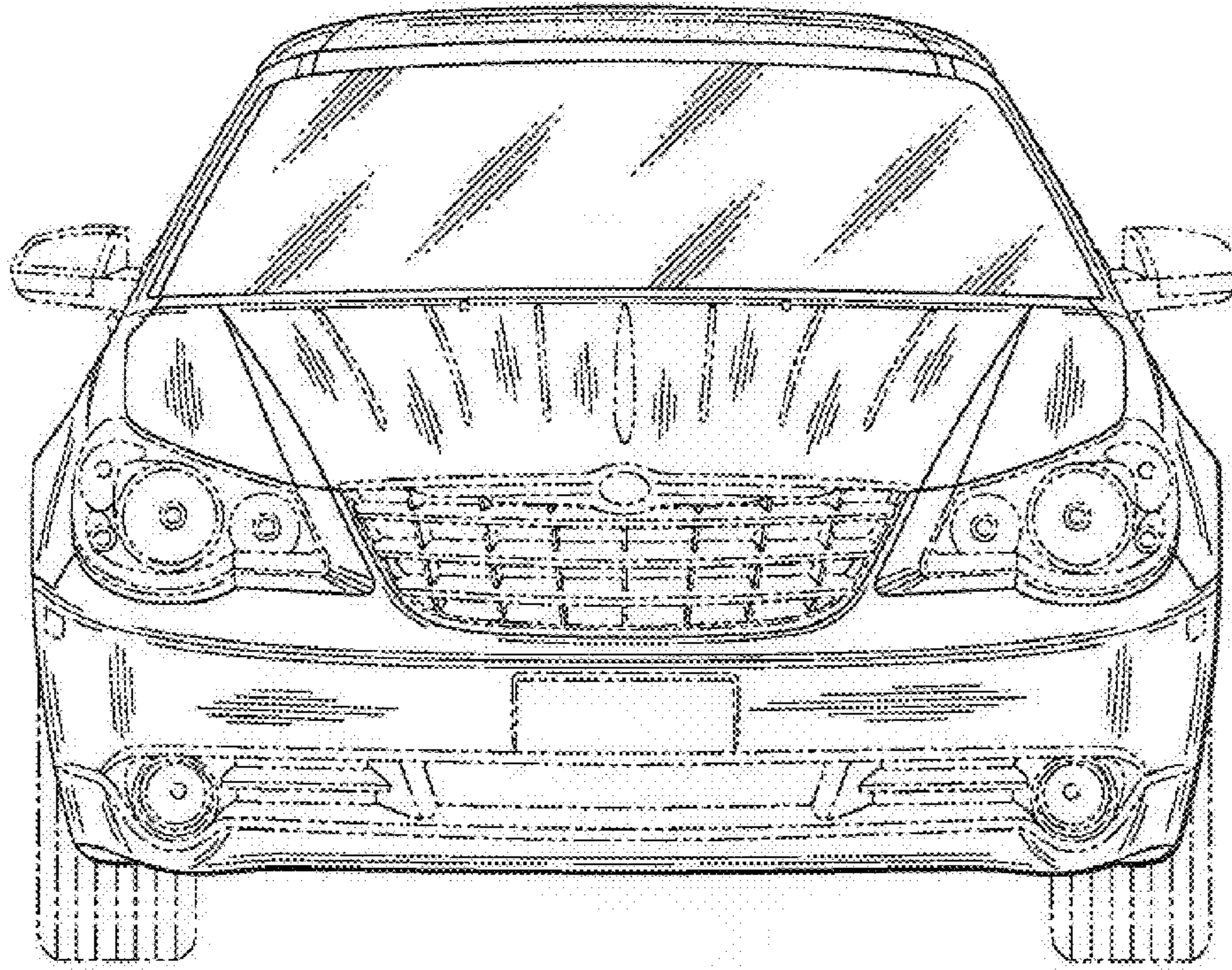

Fig. 8

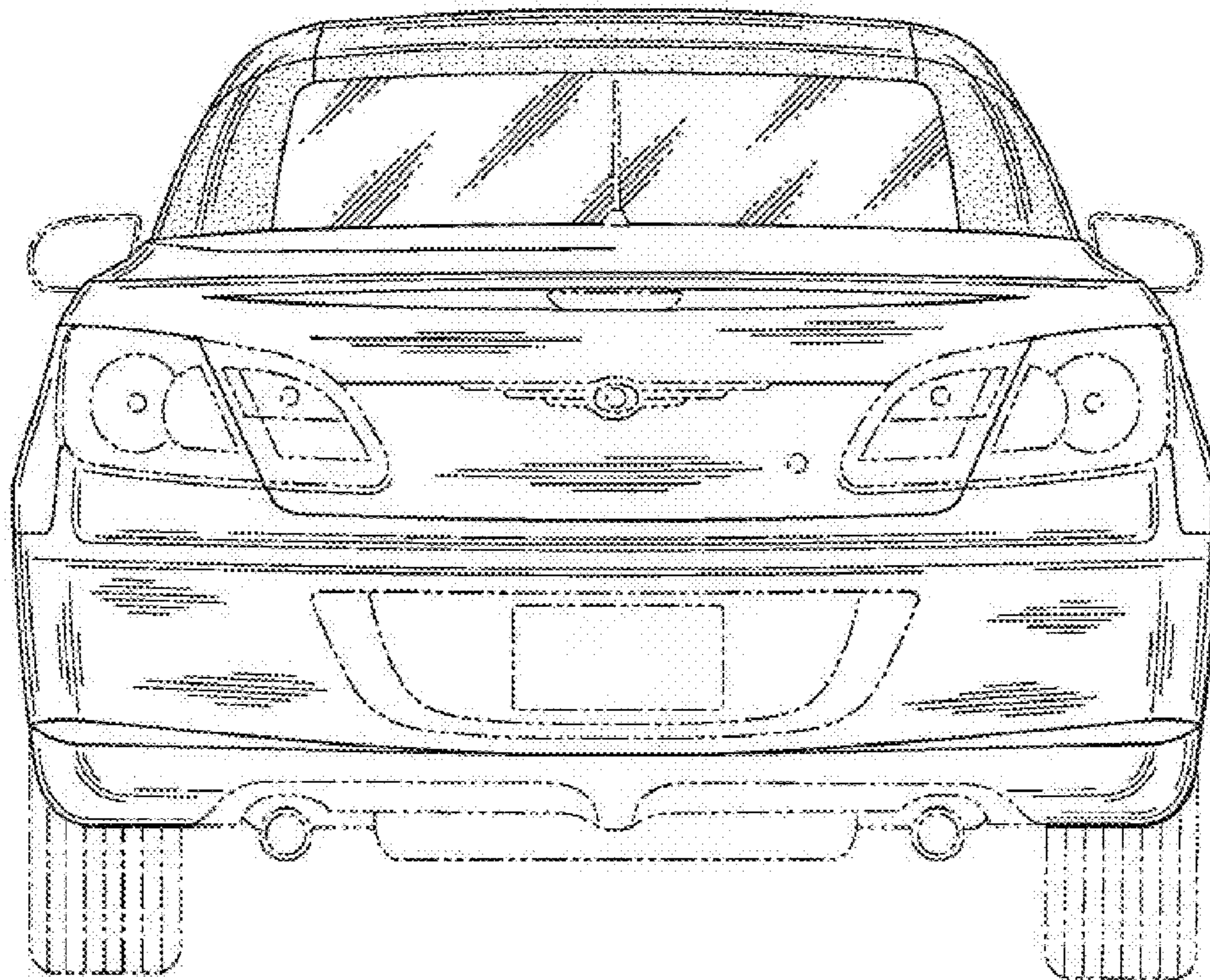

Fig. 9

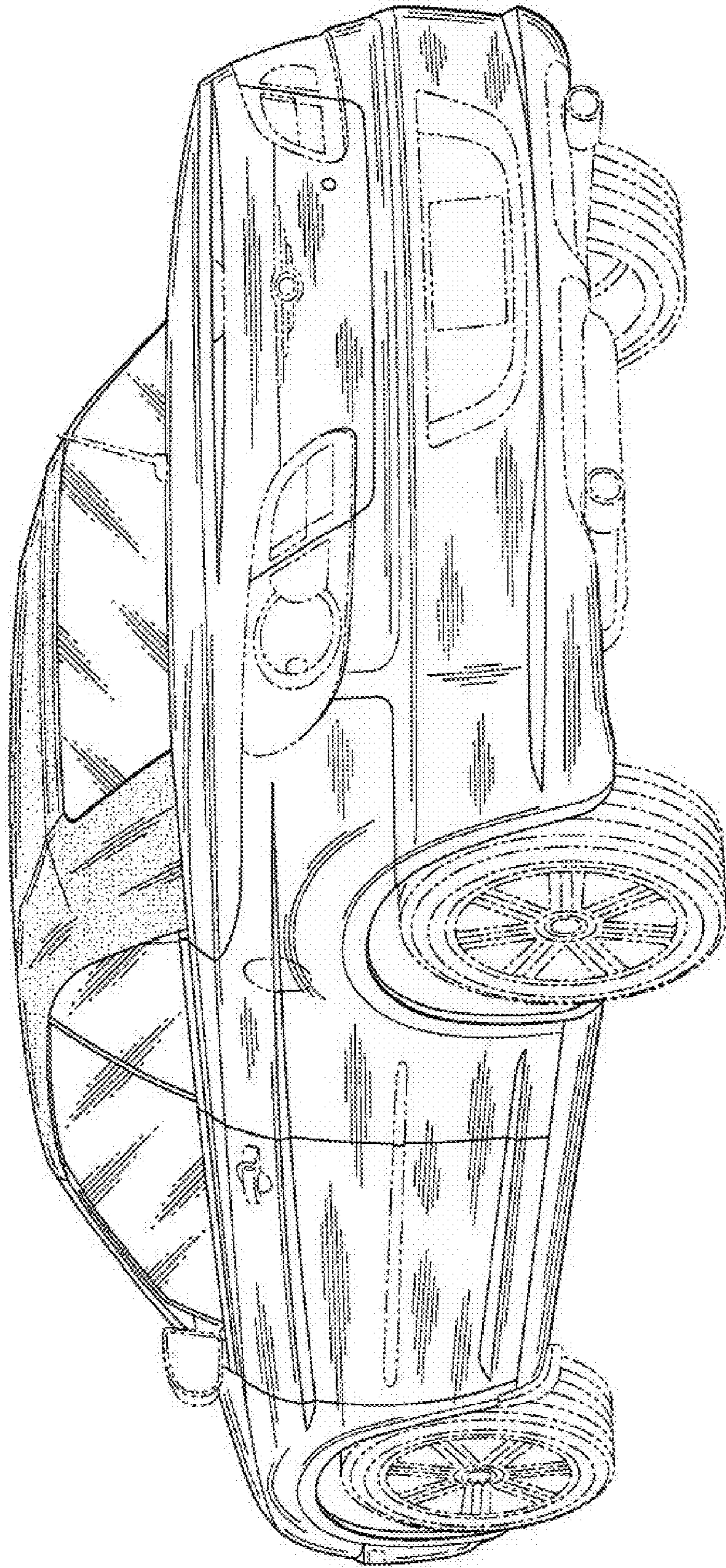

Fig. 10

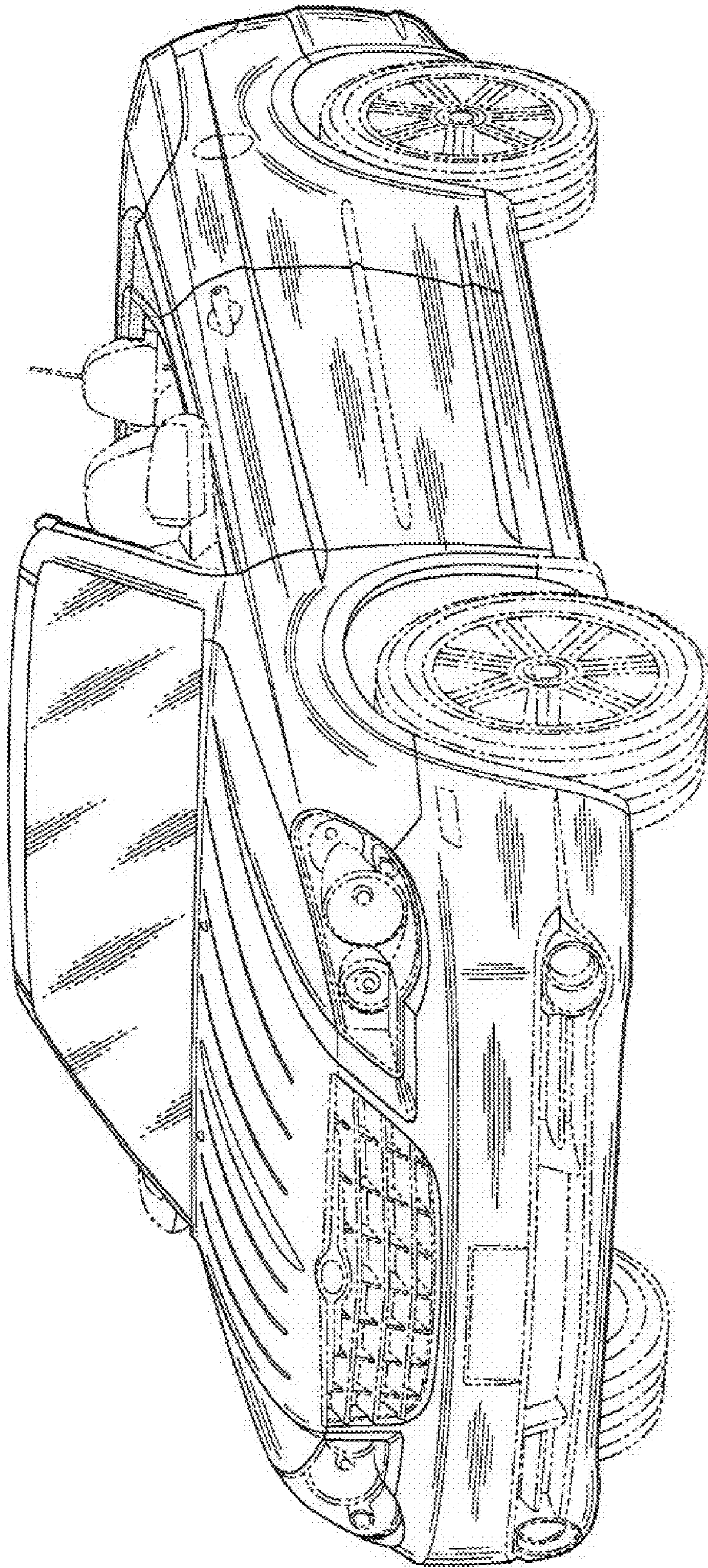

Fig. 11

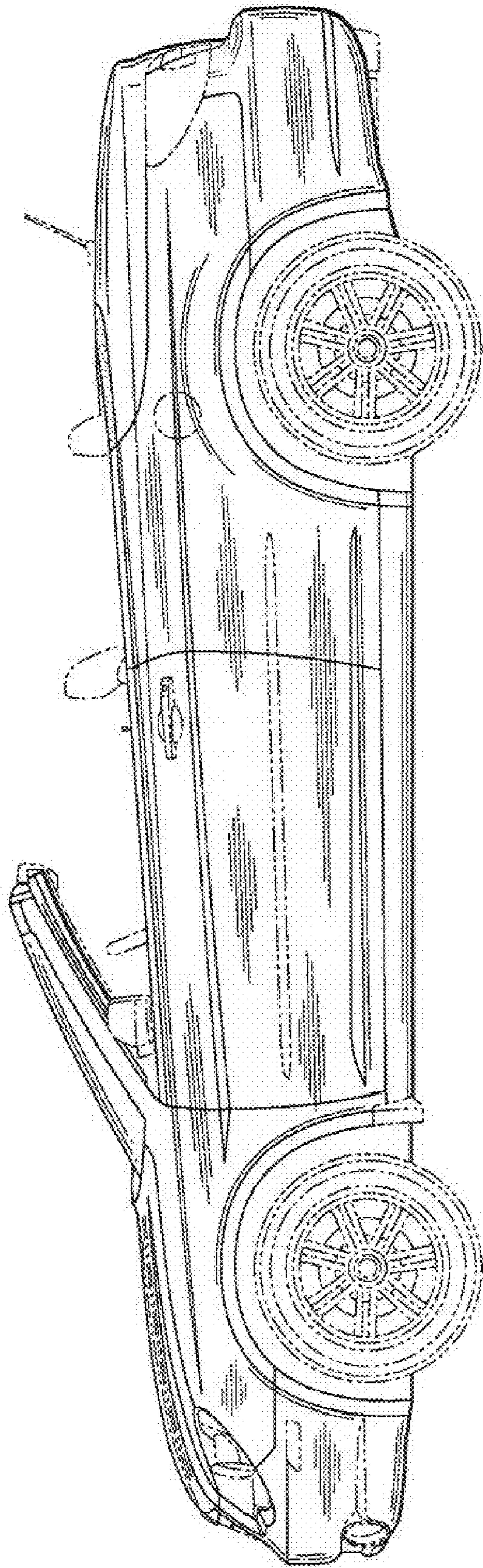

Fig. 12

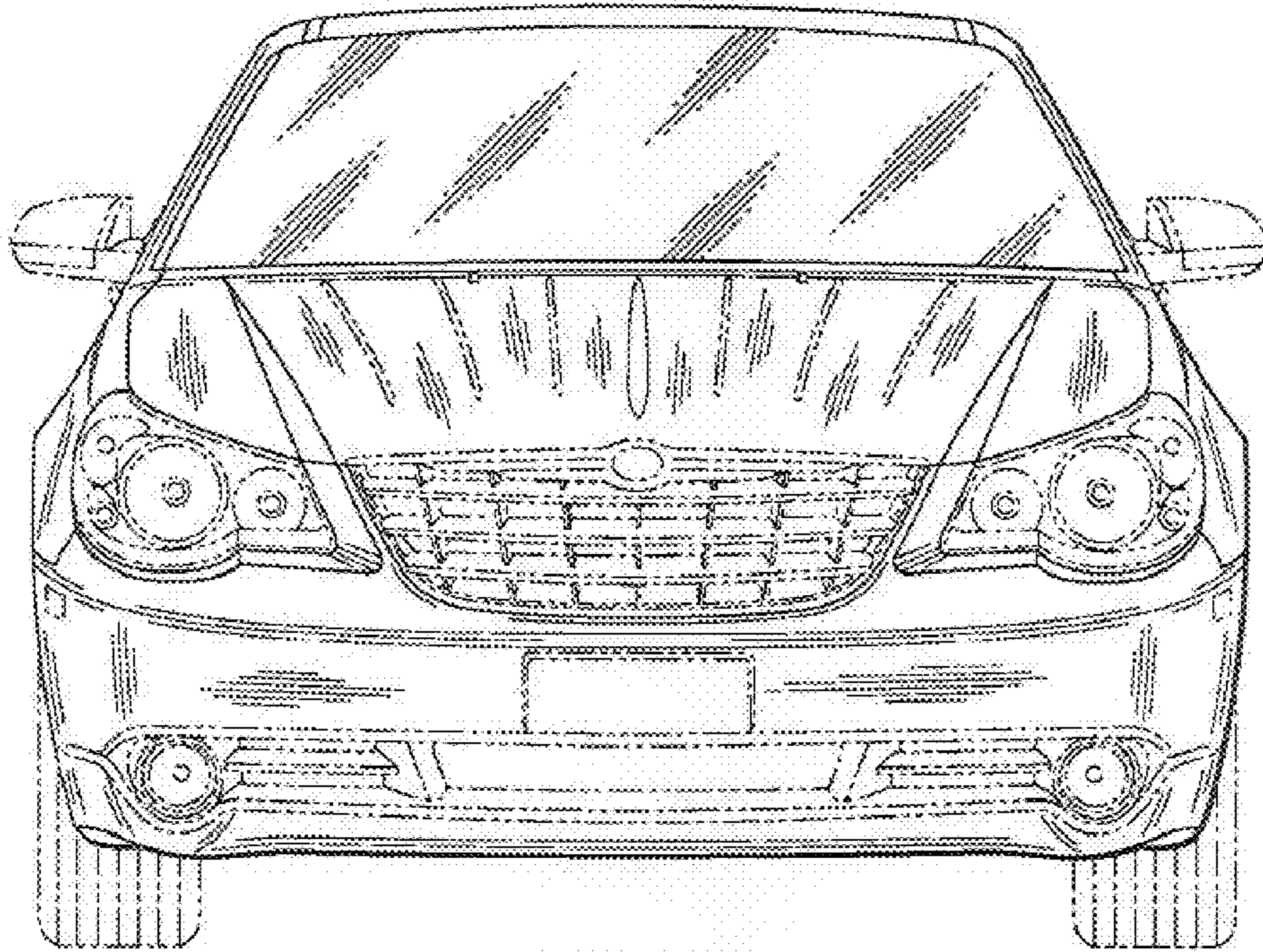

Fig. 13

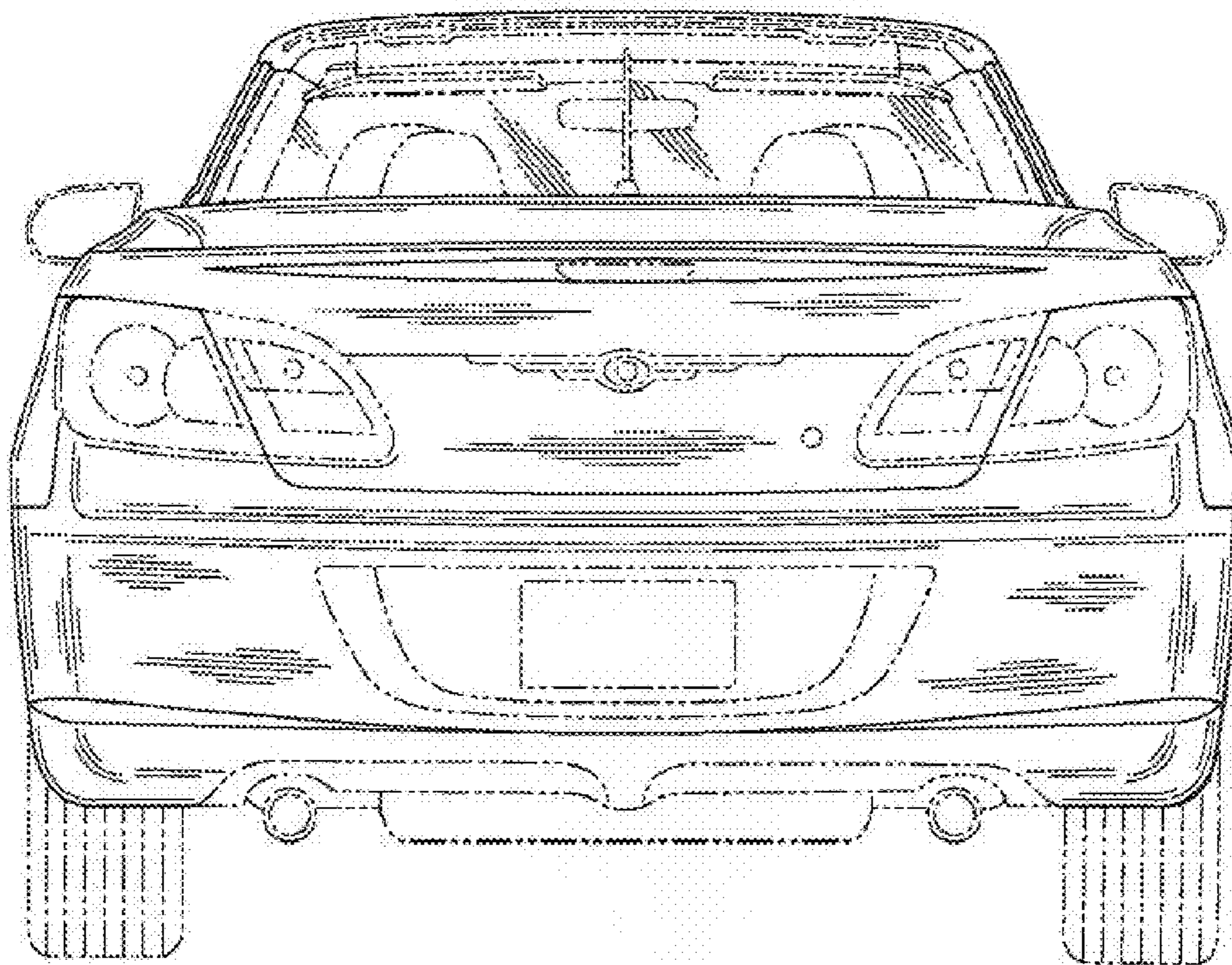

Fig. 14

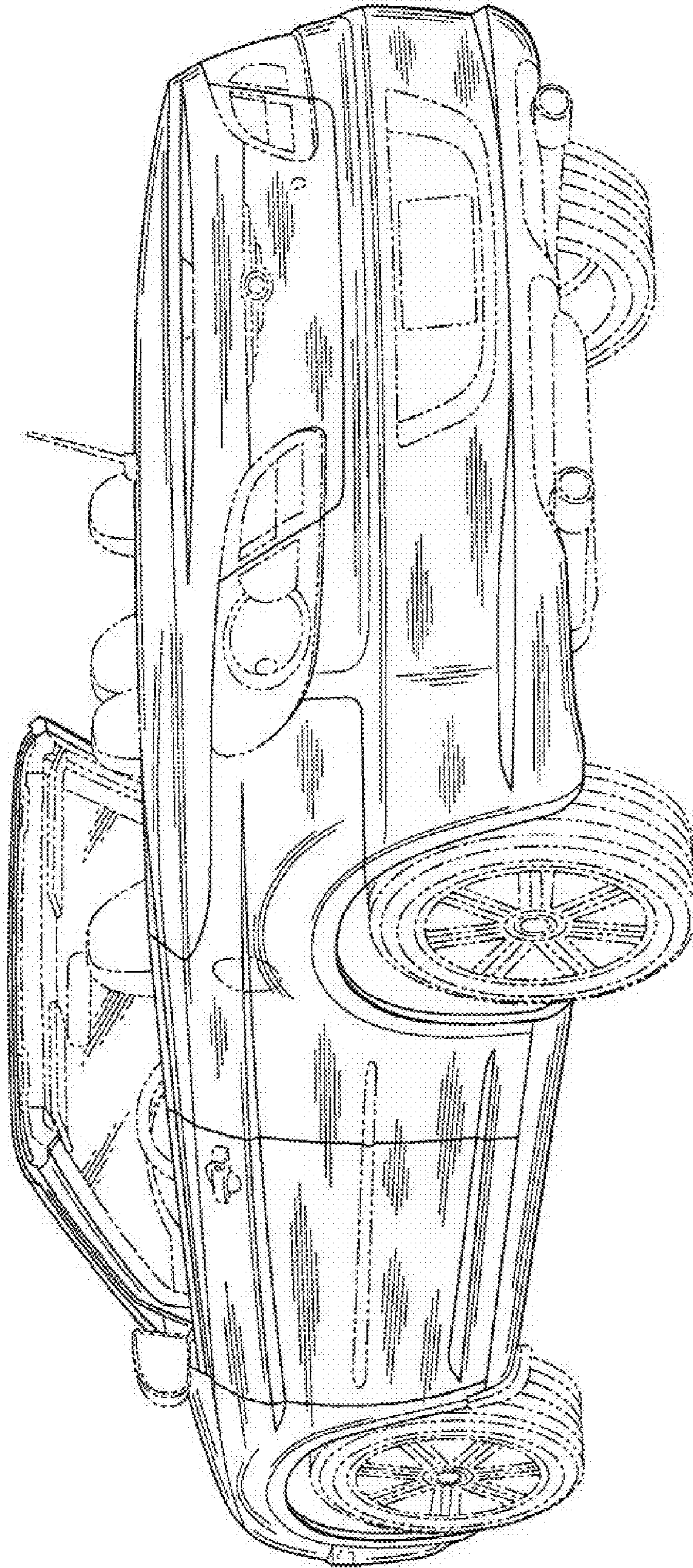

Fig. 15