



US00D559055S

(12) **United States Design Patent**
Axinte et al.

(10) **Patent No.:** **US D559,055 S**

(45) **Date of Patent:** **** Jan. 8, 2008**

(54) **SOLDERING IRON**

(75) Inventors: **Grigore Axinte**, Bellevue, WA (US);
Russell Borgmann, Bellevue, WA
(US); **Jeff Campbell**, Bellevue, WA
(US); **Kevin O'Doherty**, Kowloon Bay
(HK); **Billy Liu**, Kowloon Bay (HK);
John Lu, Renton, WA (US)

(73) Assignee: **Hyperion Innovations Inc.**, Bellevue,
WA (US)

(**) Term: **14 Years**

(21) Appl. No.: **29/269,984**

(22) Filed: **Dec. 11, 2006**

Related U.S. Application Data

(62) Division of application No. 29/215,192, filed on Oct.
13, 2004, now Pat. No. Des. 533,416.

(51) **LOC (8) Cl.** **08-05**

(52) **U.S. Cl.** **D8/30**

(58) **Field of Classification Search** D8/30,
D8/29.1, 29.2; 219/227, 228, 229, 235, 236,
219/238

See application file for complete search history.

(56) **References Cited**

U.S. PATENT DOCUMENTS

D300,200 S *	3/1989	Arehart	D8/30
D305,720 S *	1/1990	Leech et al.	D8/30
D317,704 S *	6/1991	Zaborowski et al.	D8/30
D330,998 S *	11/1992	Watmore et al.	D8/30
D334,695 S *	4/1993	Watmore et al.	D8/30
5,928,536 A *	7/1999	Lee	219/229
D442,447 S *	5/2001	Fujiwara	D8/30
D514,407 S *	2/2006	Lin	D8/30
D516,884 S *	3/2006	Axinte et al.	D8/30

* cited by examiner

Primary Examiner—Philip Hyder
(74) *Attorney, Agent, or Firm*—Perkins Coie LLP

(57) **CLAIM**

The ornamental design for a soldering iron, as shown and described.

DESCRIPTION

FIG. 1 is a top perspective view of a first embodiment of a soldering iron;

FIG. 2 is a bottom perspective view of the soldering iron of FIG. 1;

FIG. 3 is a top view of the soldering iron of FIG. 1;

FIG. 4 is a side elevational view of the soldering iron of FIG. 1;

FIG. 5 is a bottom view of the soldering iron of FIG. 1;

FIG. 6 is a front elevational view of the soldering iron of FIG. 1;

FIG. 7 is a rear elevational view of the soldering iron of FIG. 1;

FIG. 8 is a top perspective view of a second embodiment of a soldering iron;

FIG. 9 is a bottom perspective view of the soldering iron of FIG. 8;

FIG. 10 is a top view of the soldering iron of FIG. 8;

FIG. 11 is a side elevational view of the soldering iron of FIG. 8;

FIG. 12 is a bottom view of the soldering iron of FIG. 8;

FIG. 13 is a front elevational view of the soldering iron of FIG. 8; and,

FIG. 14 is a rear elevational view of the soldering iron of FIG. 8.

The broken line portions of the disclosure illustrate unclaimed structure.

1 Claim, 4 Drawing Sheets

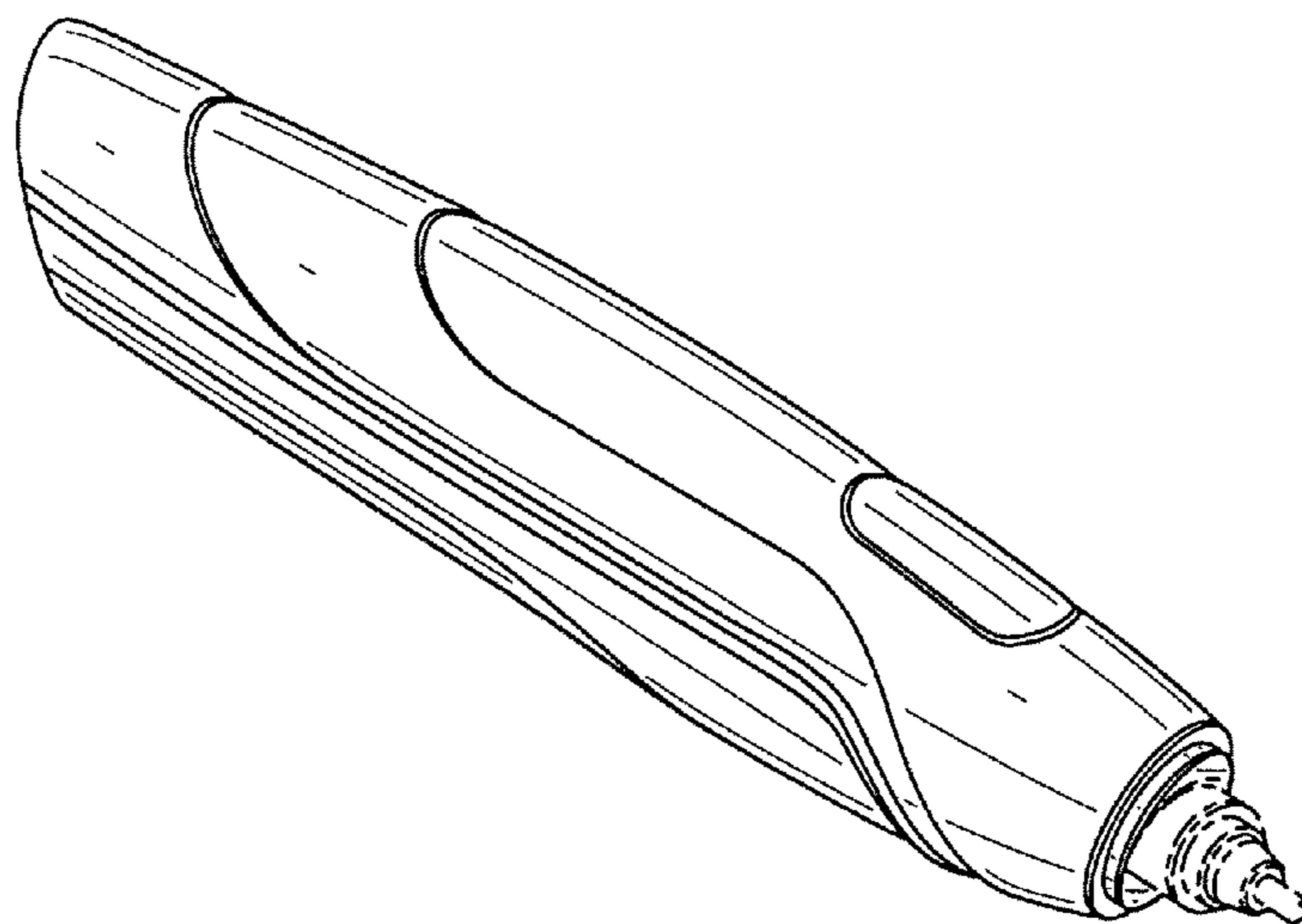

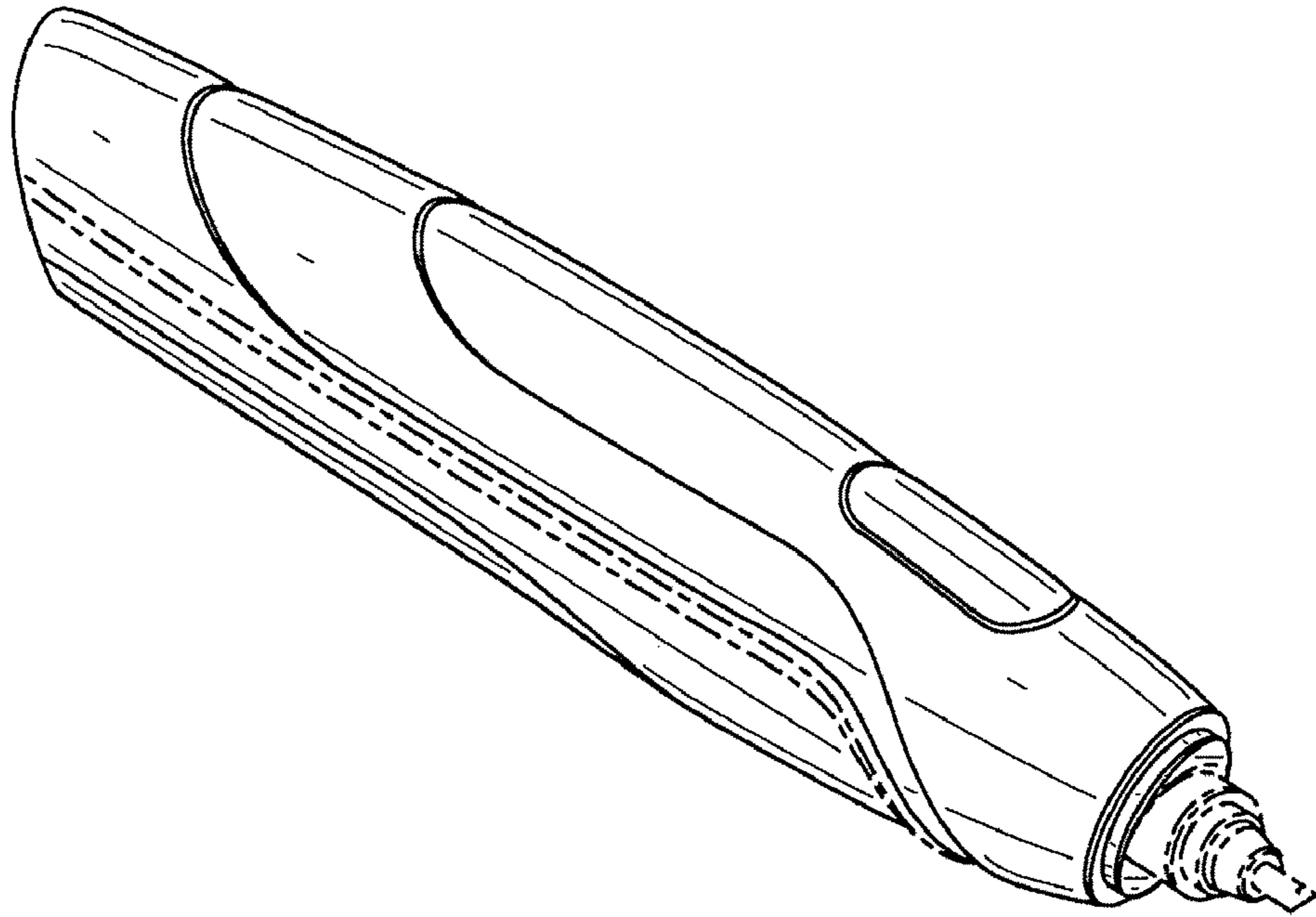

FIG. 1

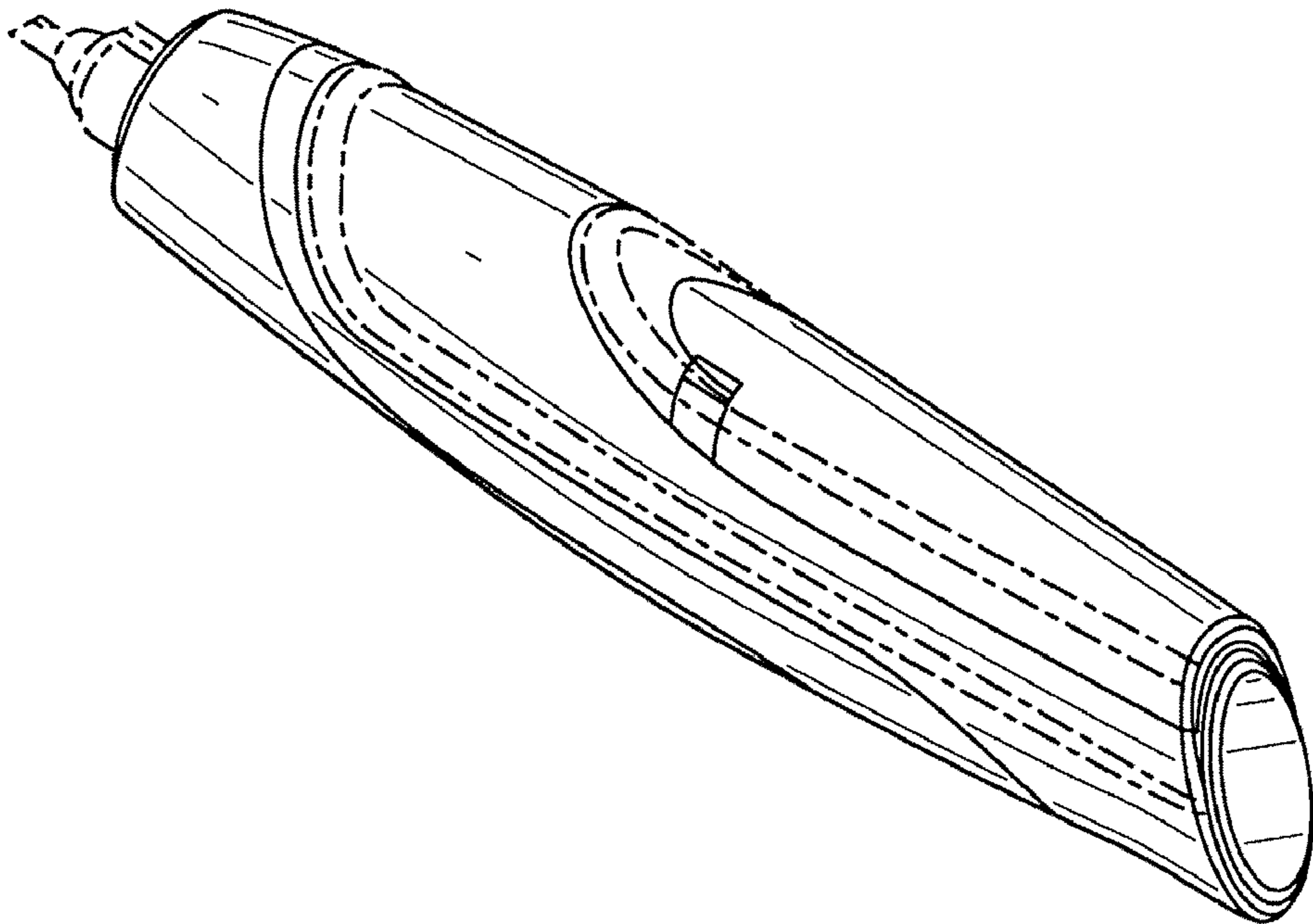

FIG. 2

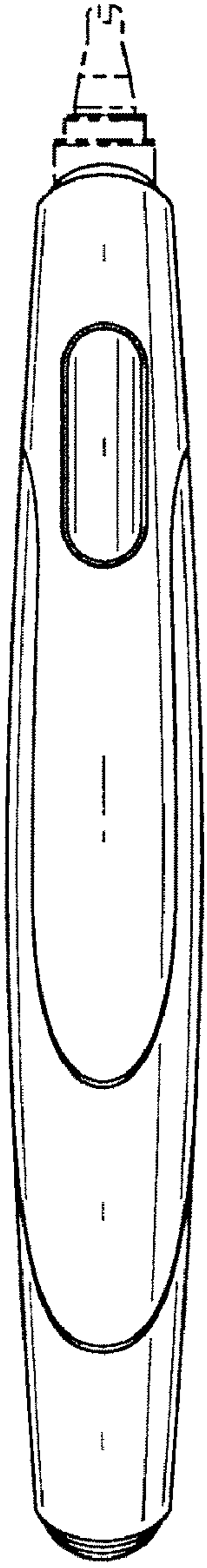

FIG. 3

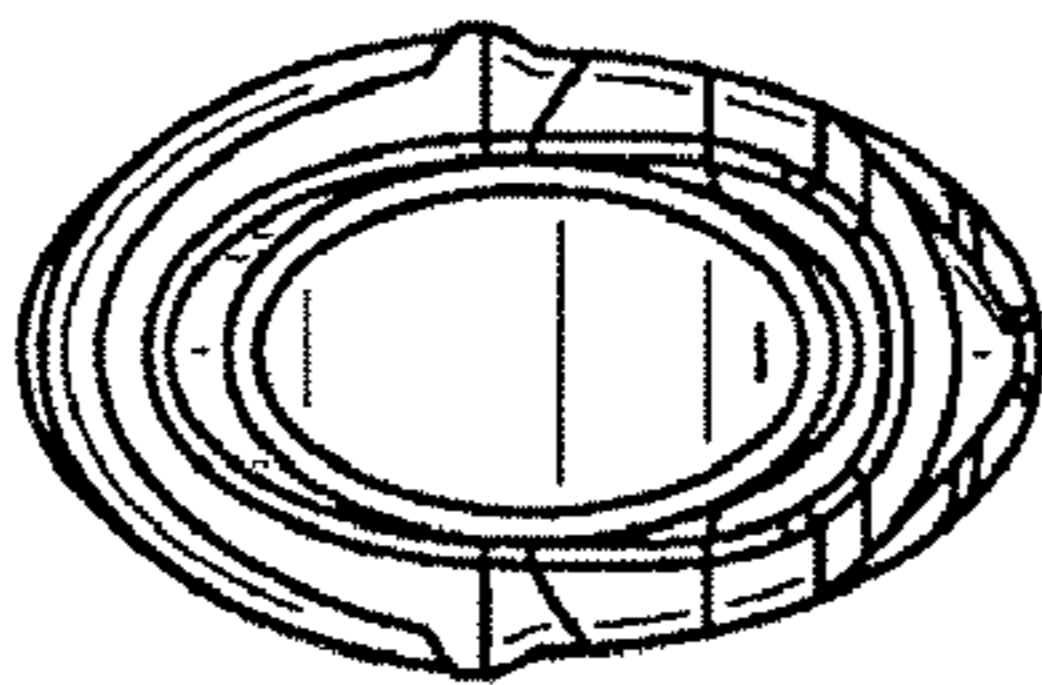

FIG. 6

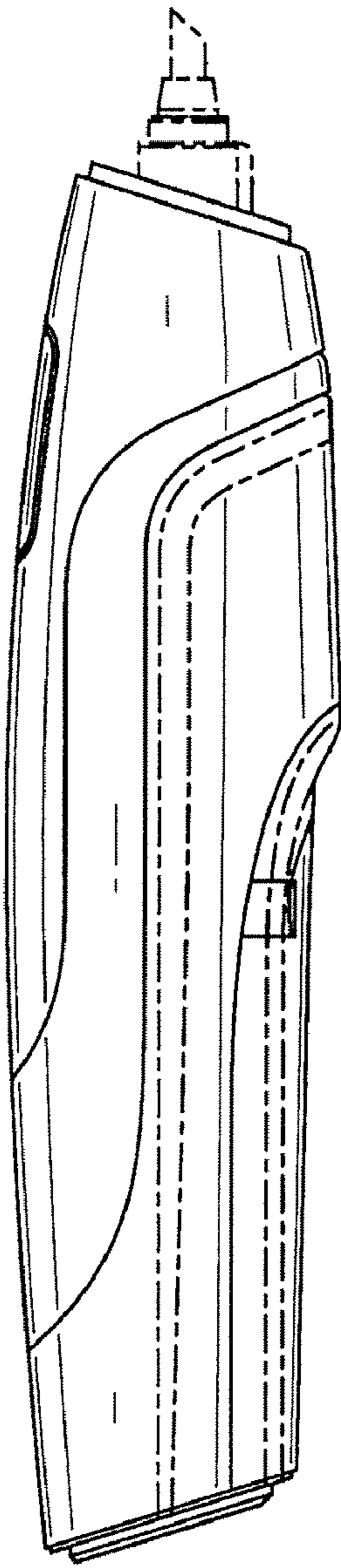

FIG. 4

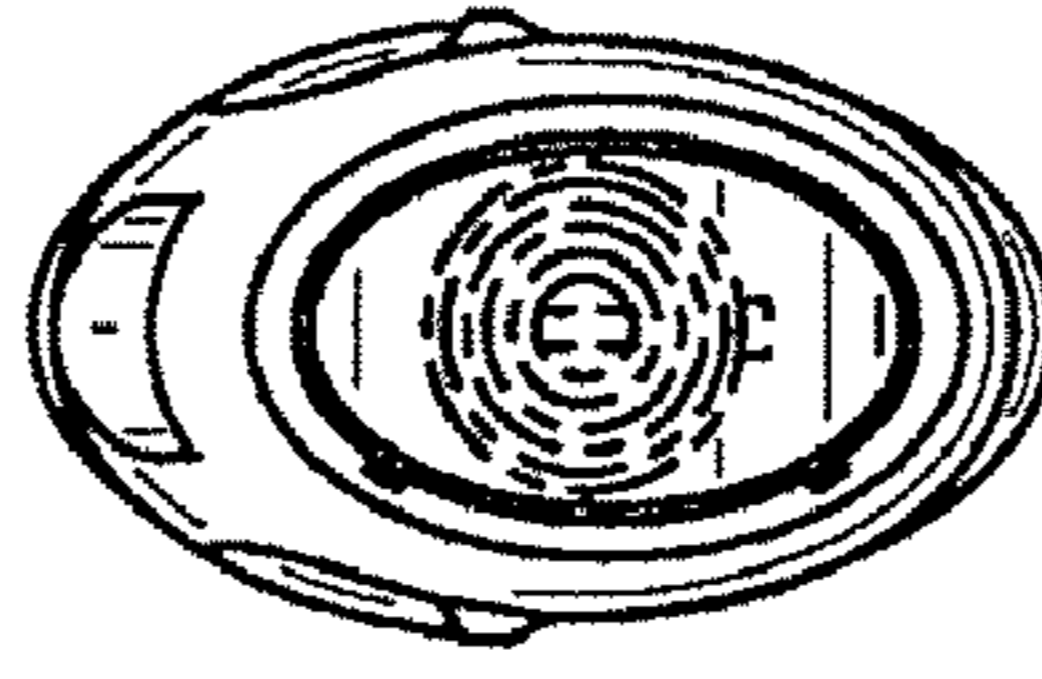

FIG. 7

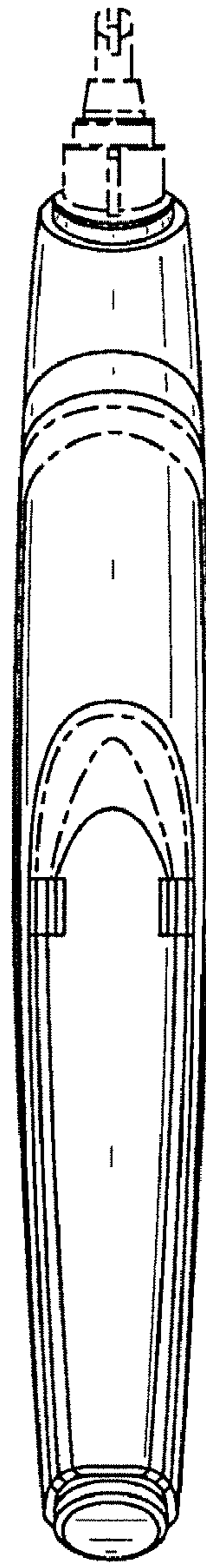

FIG. 5

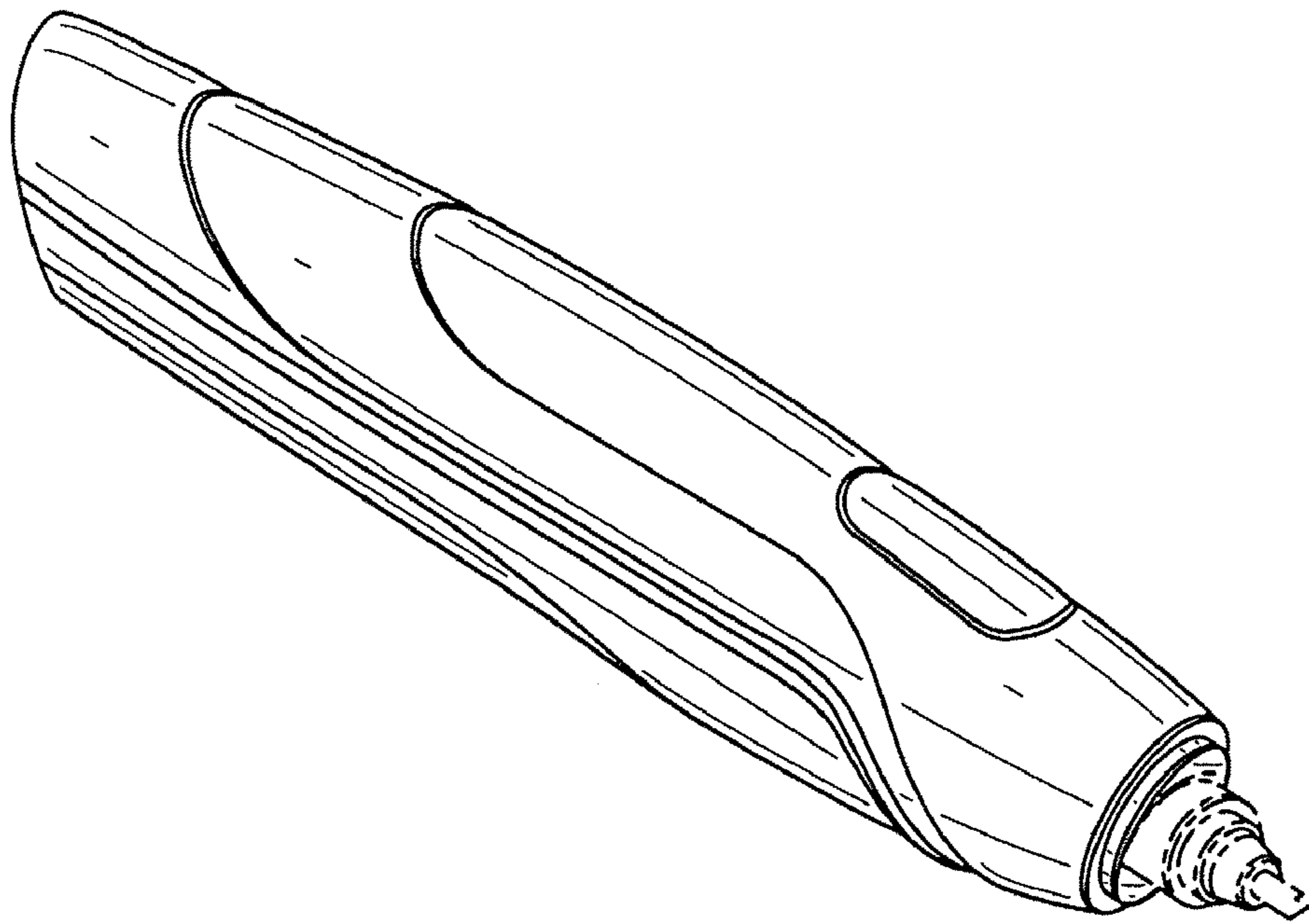

FIG. 8

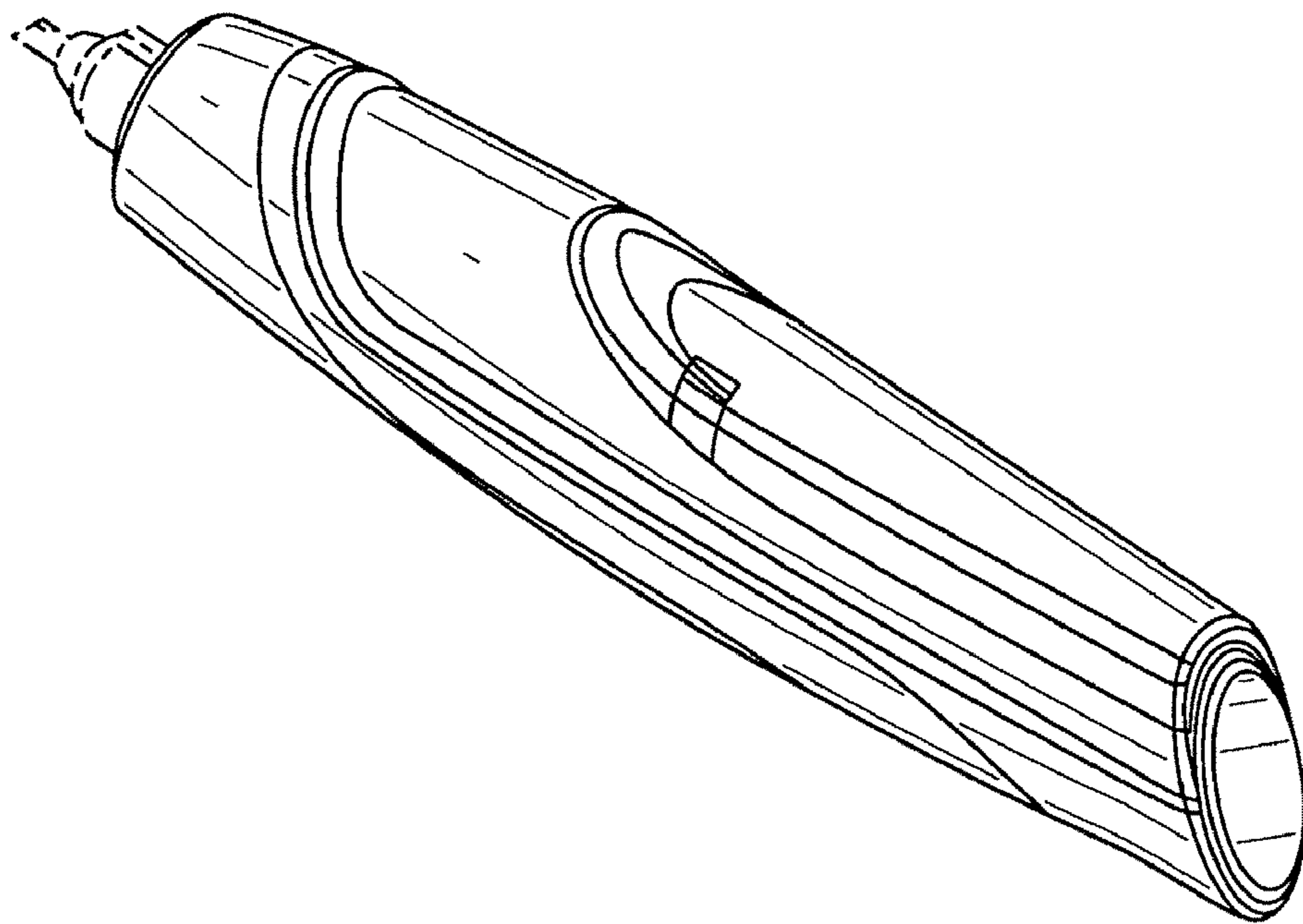

FIG. 9

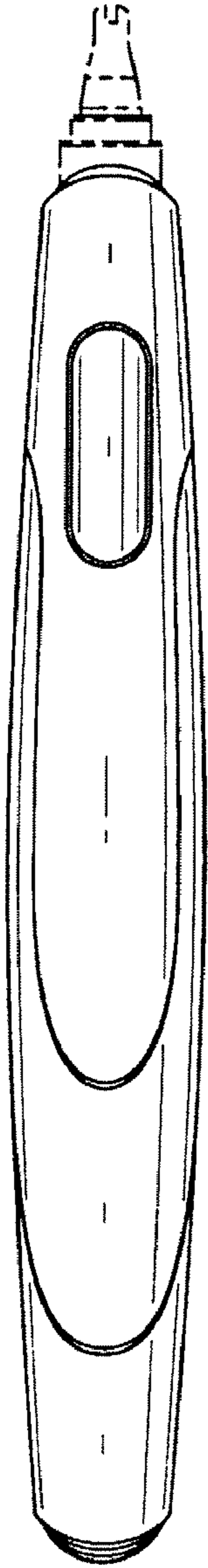

FIG. 10

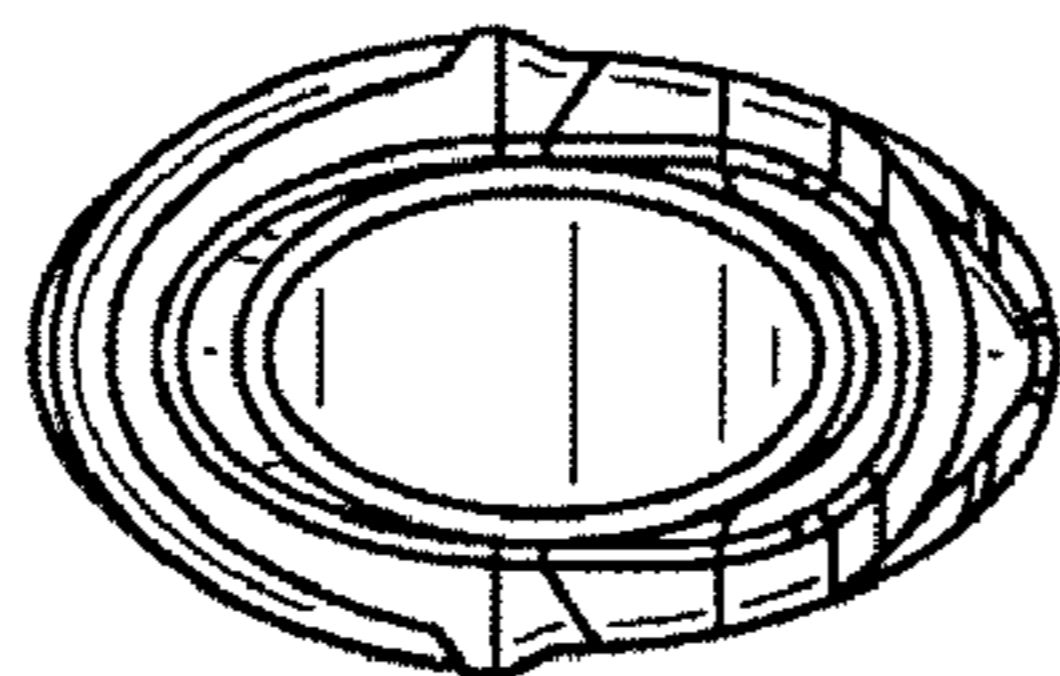

FIG. 13

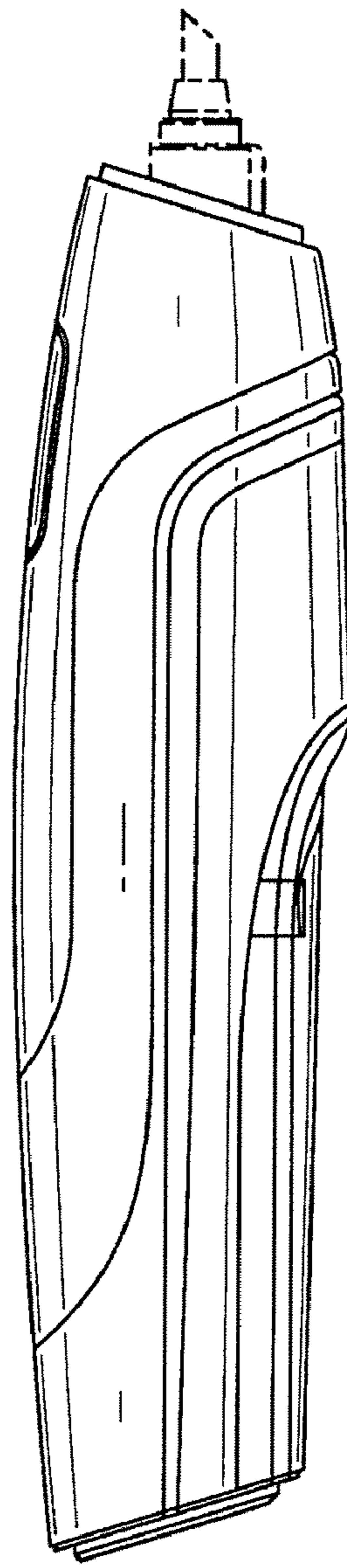

FIG. 11

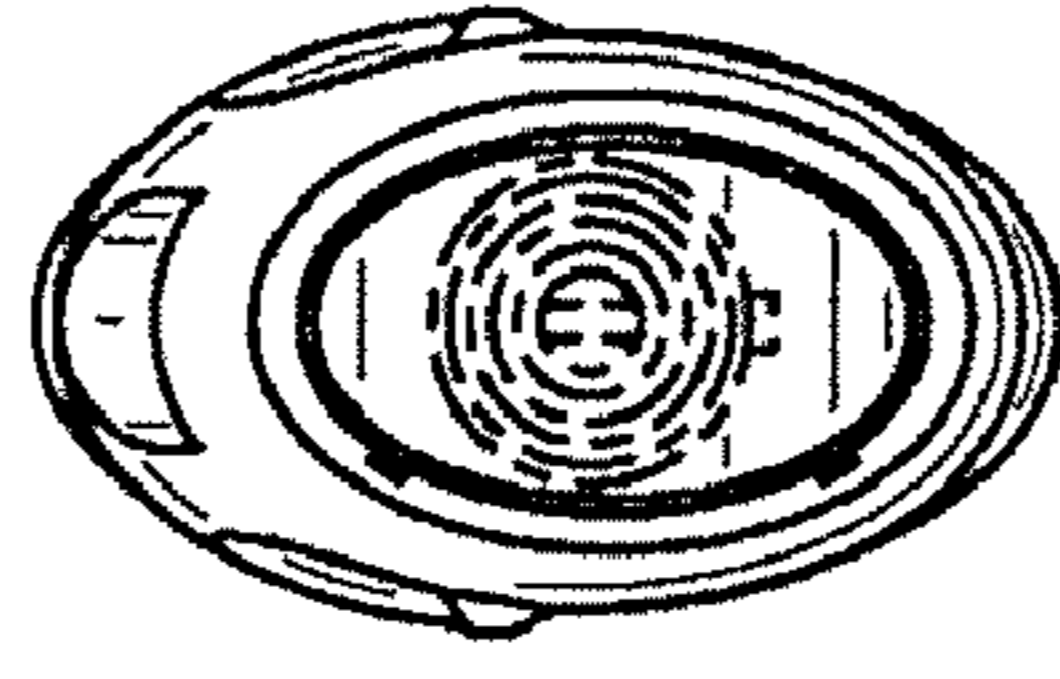

FIG. 14

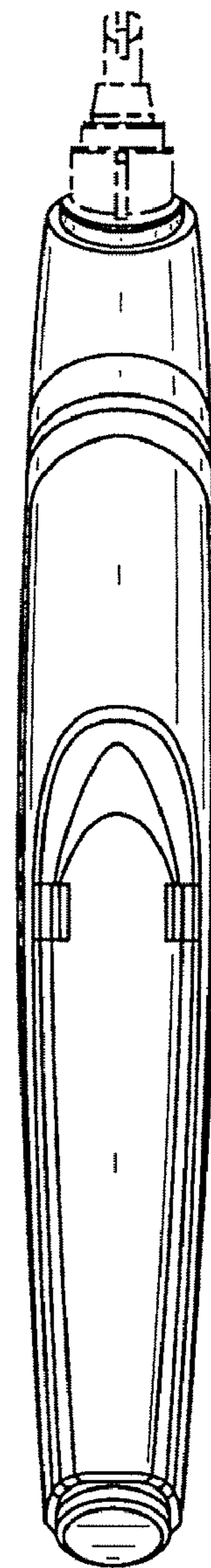

FIG. 12