



US00D559054S

(12) **United States Design Patent**
Tuan Mu

(10) **Patent No.:** **US D559,054 S**
(45) **Date of Patent:** **** Jan. 8, 2008**

(54) **REVERSIBLE RATCHETING WRENCH**

(75) Inventor: **Hsien Chung Tuan Mu**, Taichung (TW)

(73) Assignee: **Lea Way Hand Tool Corporation**, Taichung (TW)

(**) Term: **14 Years**

(21) Appl. No.: **29/278,170**

(22) Filed: **Mar. 21, 2007**

(51) **LOC (8) Cl.** **08-05**

(52) **U.S. Cl.** **D8/25**

(58) **Field of Classification Search** D8/17,
D8/21-29, 105, 107, 52, 55; 81/124.2, 125,
81/125.1, 176.1, 176.2, 177.1, 177.2, 177.3,
81/177.85, 124.3, 124.7, 176.3, 58.3, 300,
81/58.1, 60-63.2, 121.7, 436, 437, 165, 418,
81/166, 168, 169, 170, 179, 160, 3.57, 3.55,
81/58.4, 186, 176.15, 121.1, 489, 490, 22,
81/129, 479, 467, 471, 57.39, 177.9, 185.1;
140/119; 16/422, 429; 7/100, 138, 168,
7/157

See application file for complete search history.

(56) **References Cited**

U.S. PATENT DOCUMENTS

D486,366 S *	2/2004	Tuanmu	D8/25
D488,967 S *	4/2004	Hsien	D8/28
6,886,429 B1 *	5/2005	Lee	81/177.8
D506,372 S *	6/2005	Hsien	D8/27
D506,373 S *	6/2005	Hsien	D8/28
D507,464 S *	7/2005	Hu	D8/25
7,000,507 B1 *	2/2006	Lin	81/177.9
D517,879 S *	3/2006	Hsien	D8/28
D518,342 S *	4/2006	Hsien	D8/28
7,174,815 B1 *	2/2007	Hsieh	81/177.9
D551,042 S *	9/2007	Tuan Mu	D8/28

2003/0015070 A1* 1/2003 Chen 81/177.9
2005/0274234 A1* 12/2005 Lee 81/177.8

* cited by examiner

Primary Examiner—Raphael Barkai

Assistant Examiner—Randall H Gholson

(74) *Attorney, Agent, or Firm*—Grossman, Tucker, Perreault & Pflieger PLLC

(57) **CLAIM**

The ornamental design for a reversible ratcheting wrench, as shown and described.

DESCRIPTION

FIG. 1 is a perspective view of a reversible ratcheting wrench showing the claimed design;

FIG. 2 is a front elevational view thereof;

FIG. 3 is a rear elevational view thereof;

FIG. 4 is a left side elevational view thereof;

FIG. 5 is a right side elevational view thereof;

FIG. 6 is a top plan view thereof; and

FIG. 7 is a bottom plan view thereof.

FIG. 8 is a perspective view of a reversible ratcheting wrench showing a modified embodiment of the claimed design;

FIG. 9 is a front elevational view thereof;

FIG. 10 is a rear elevational view thereof;

FIG. 11 is a left side elevational view thereof;

FIG. 12 is a right side elevational view thereof;

FIG. 13 is a top plan view thereof; and,

FIG. 14 is a bottom plan view thereof.

The broken lines are shown for illustrative purposes and form no part of the claimed design.

1 Claim, 8 Drawing Sheets

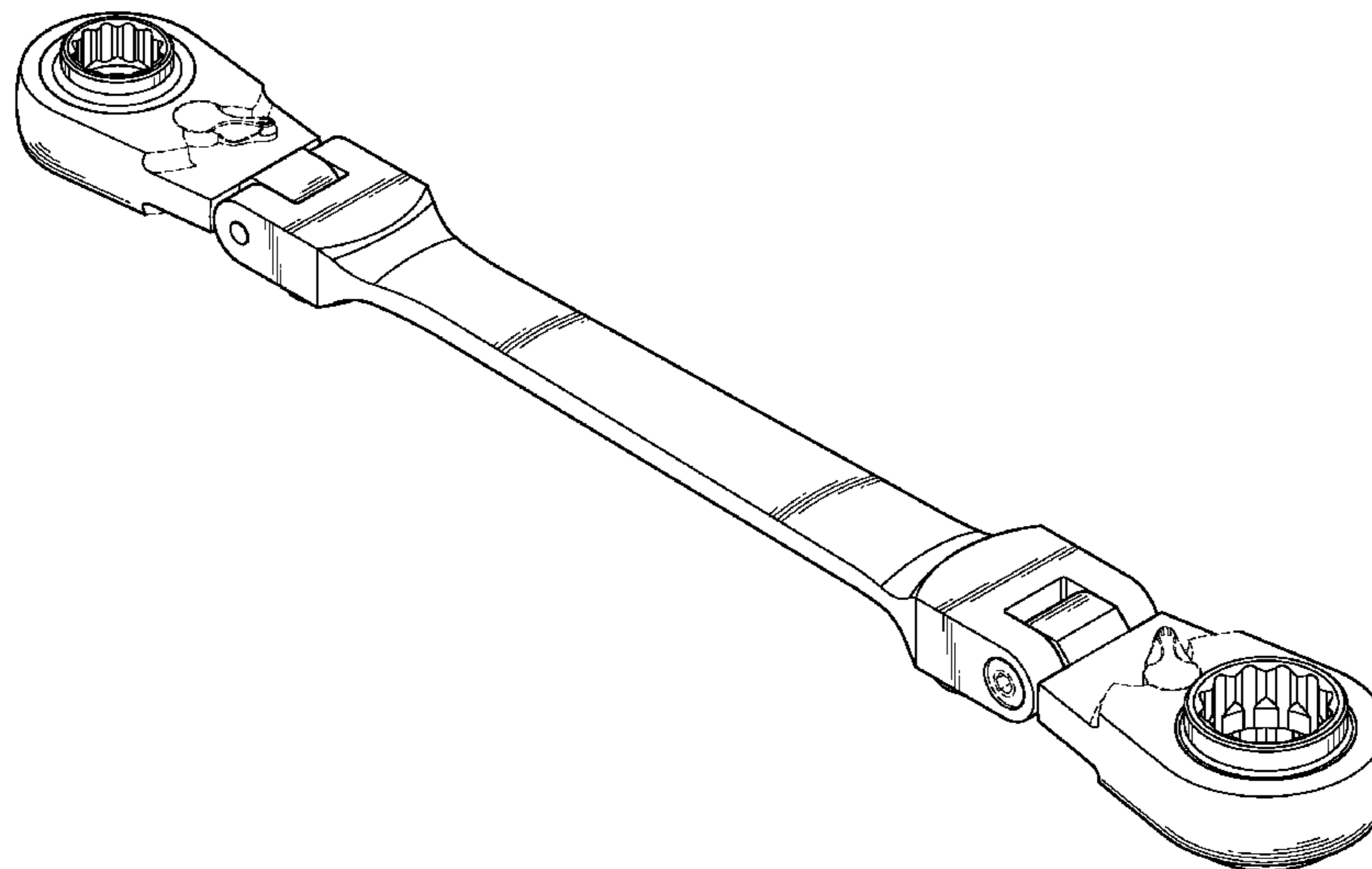

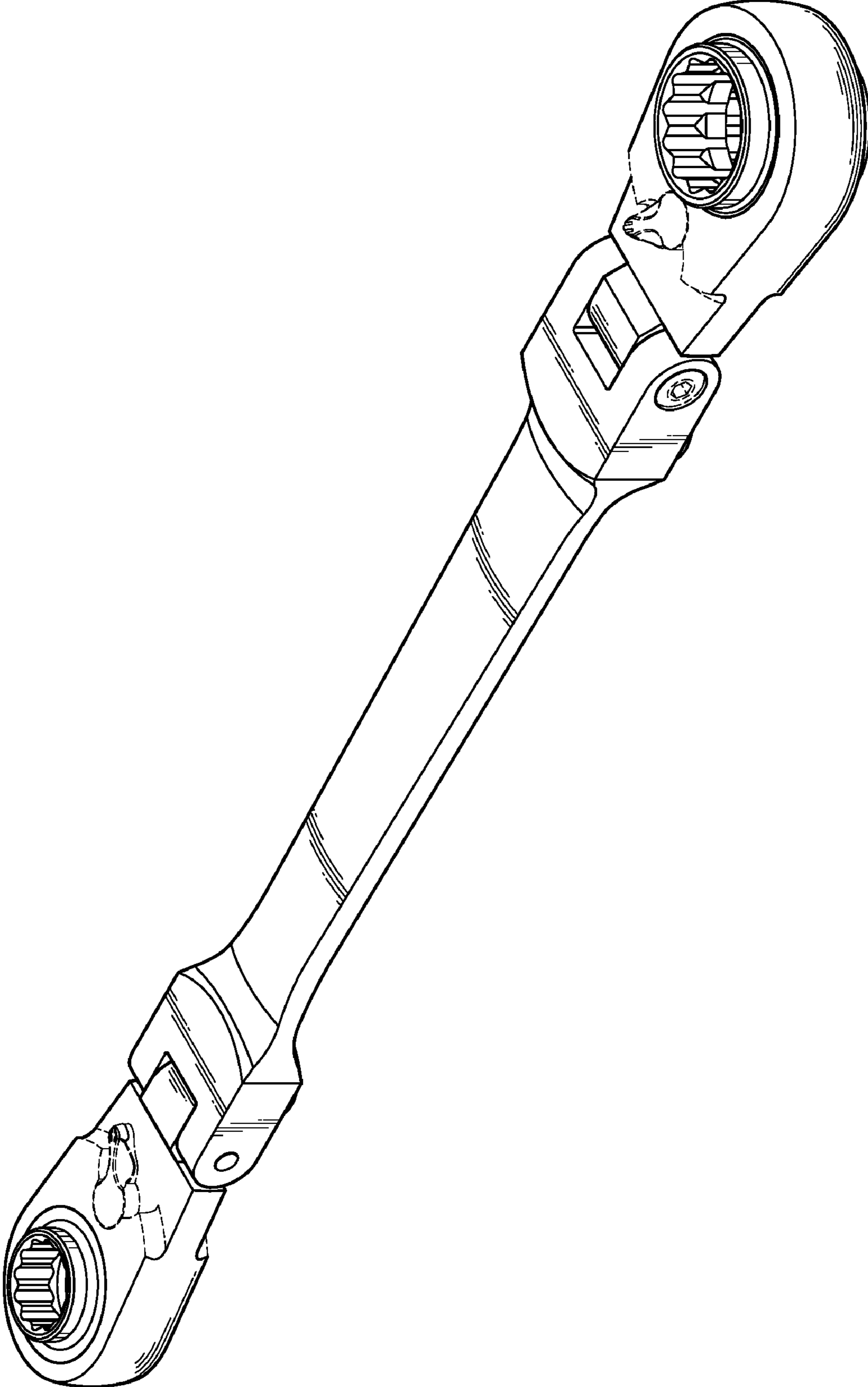

FIG. 1

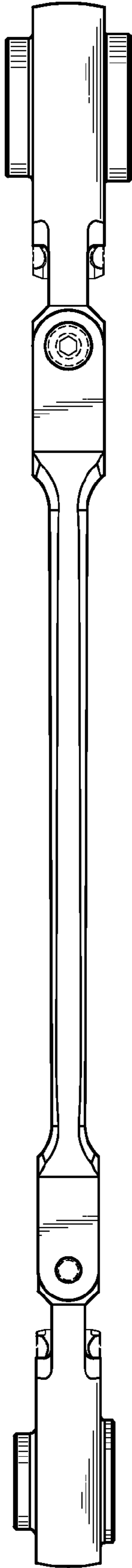

FIG. 2

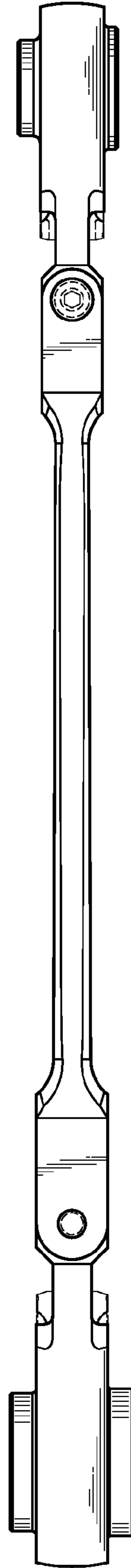

FIG. 3

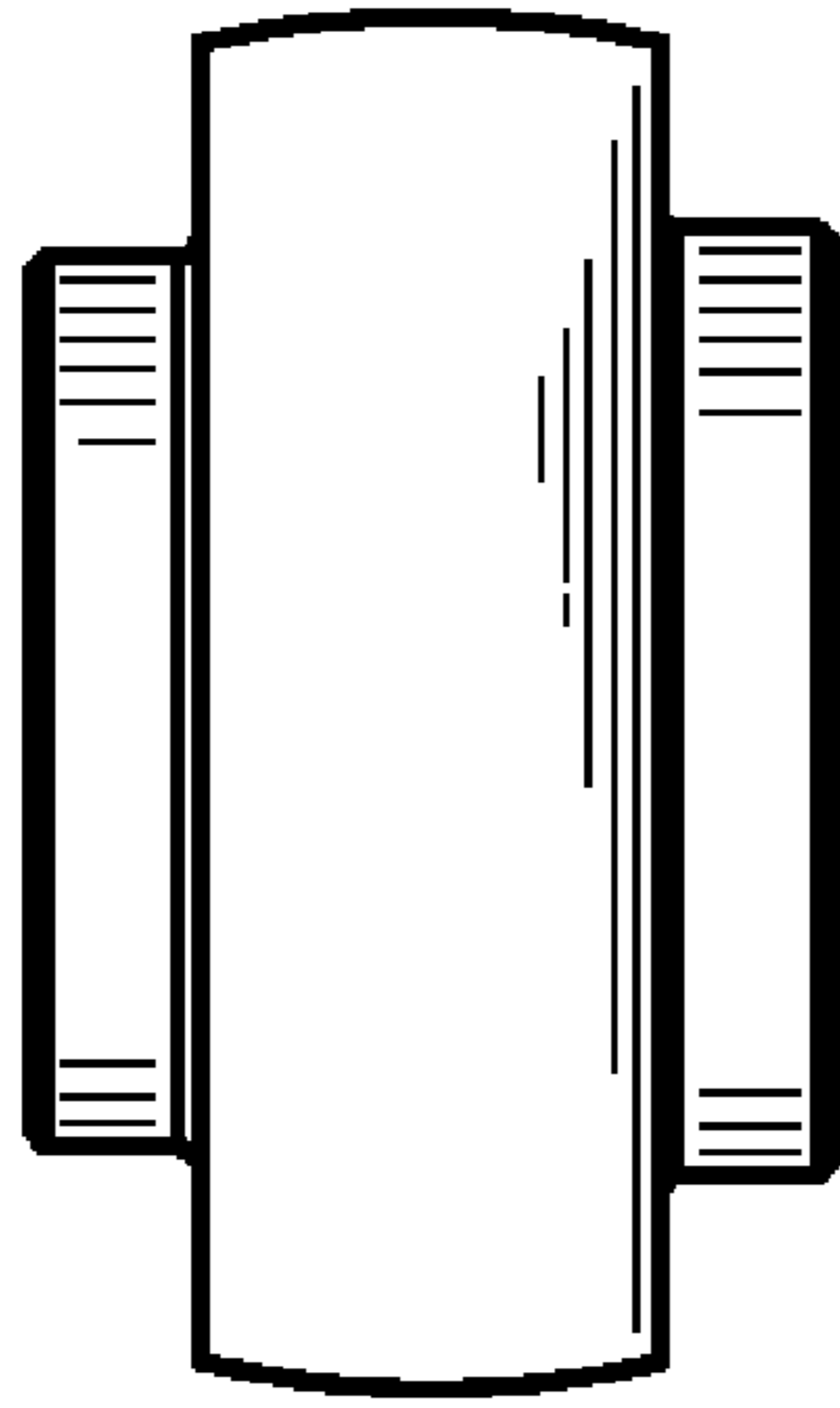

FIG.5

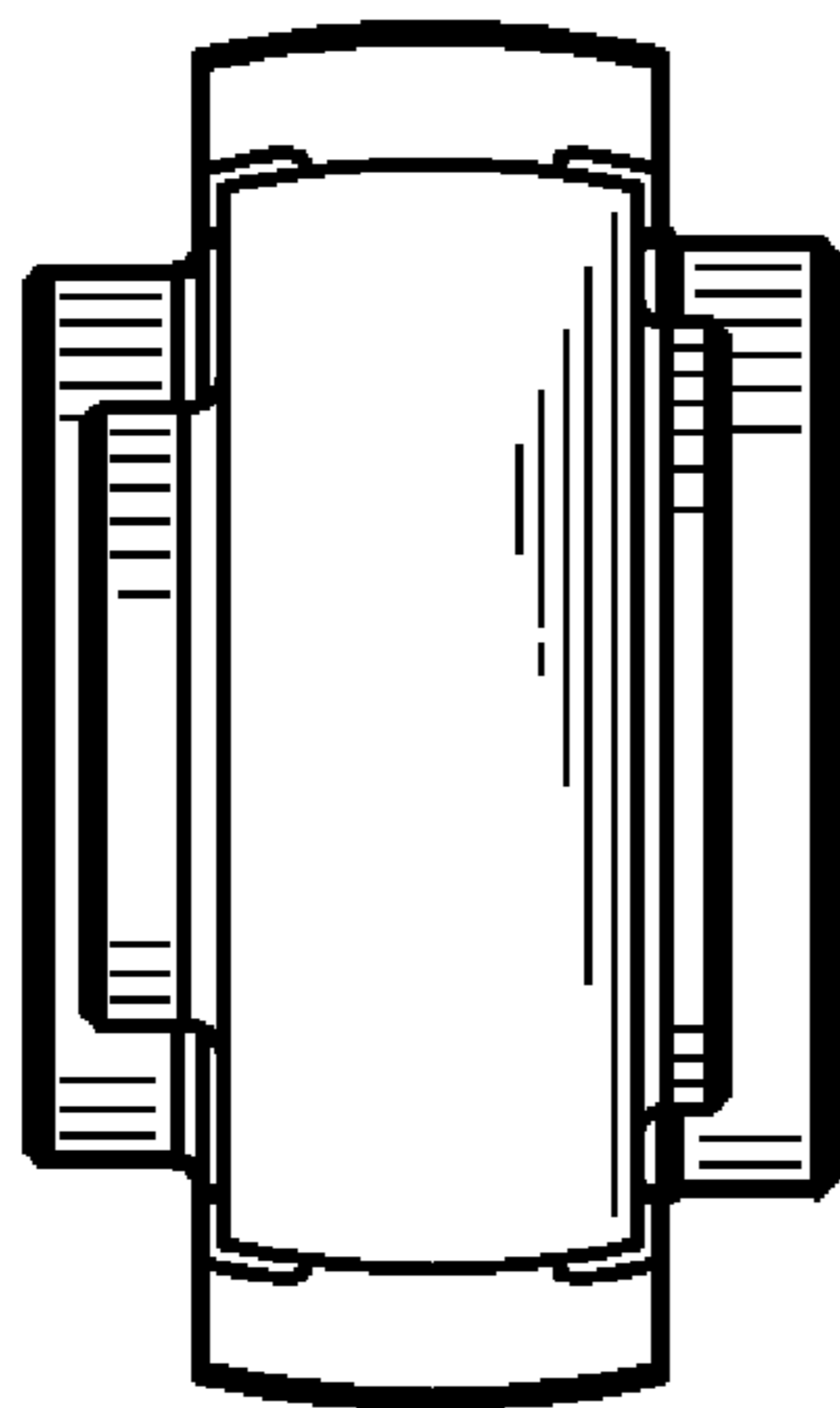

FIG.4

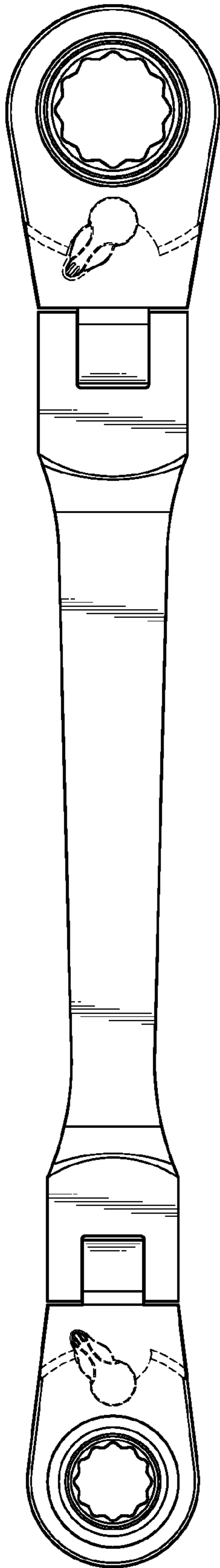

FIG. 6

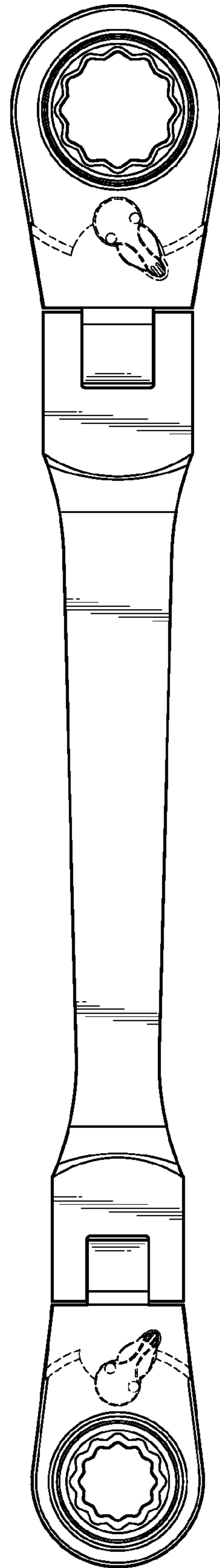

FIG. 7

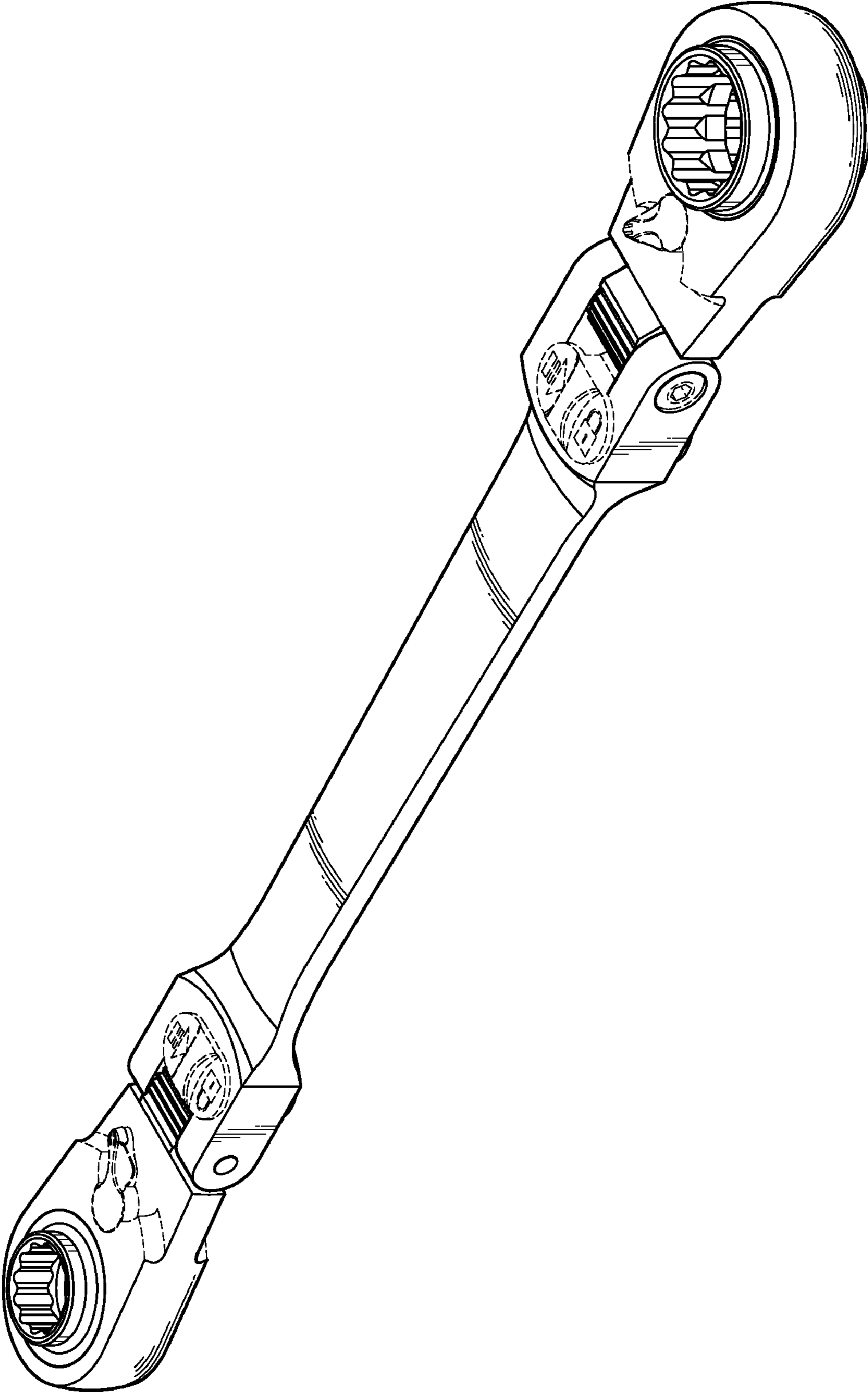

FIG.8

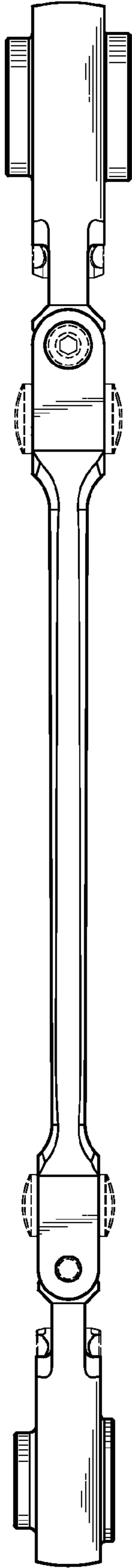

FIG. 9

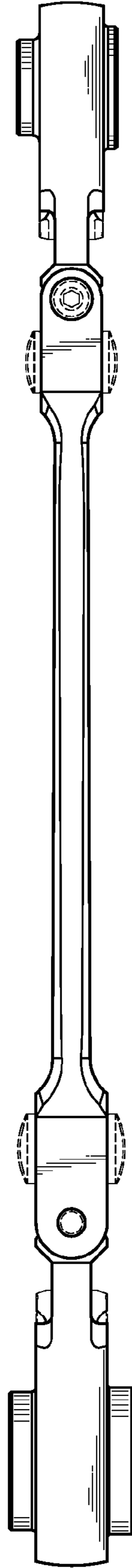

FIG. 10

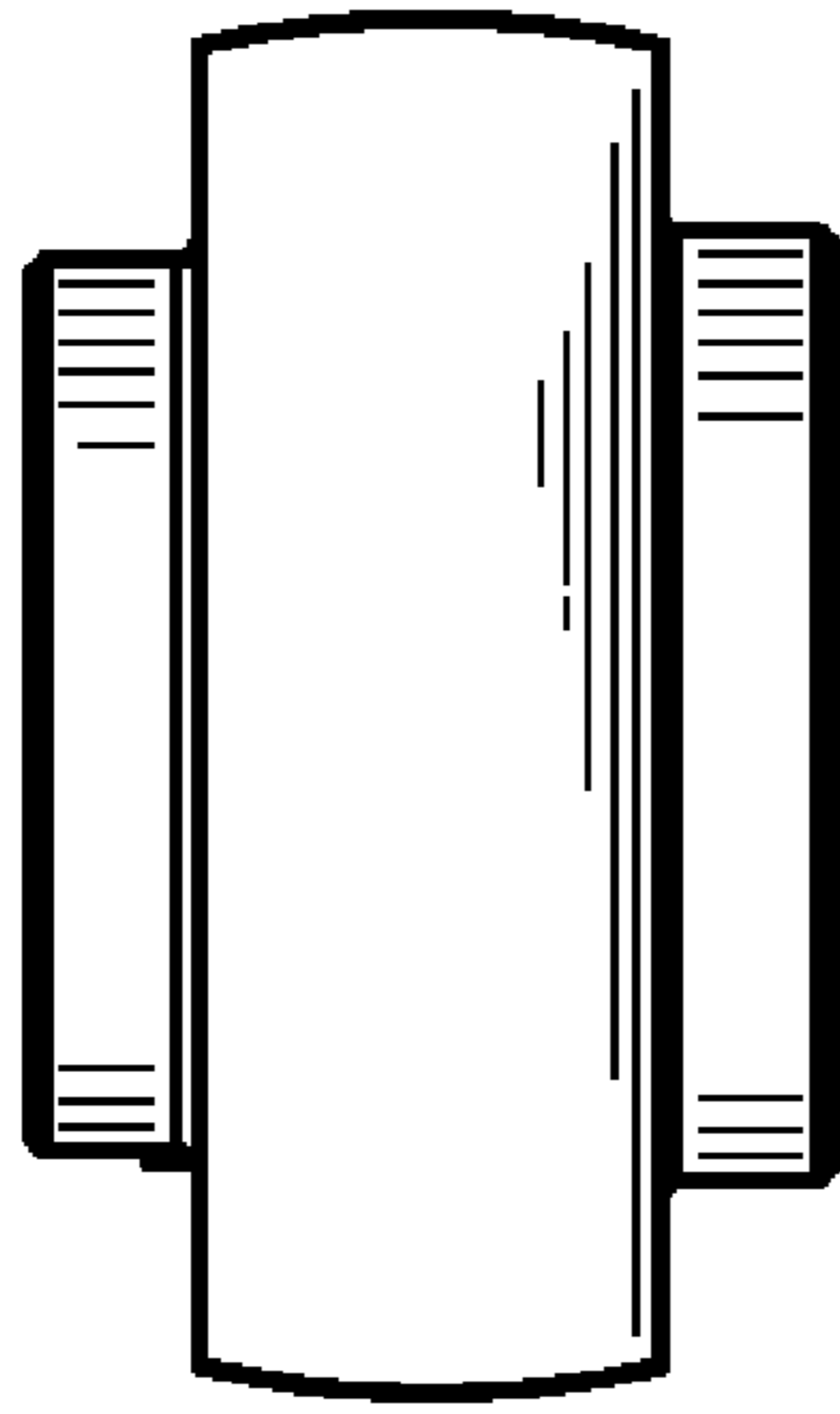

FIG.12

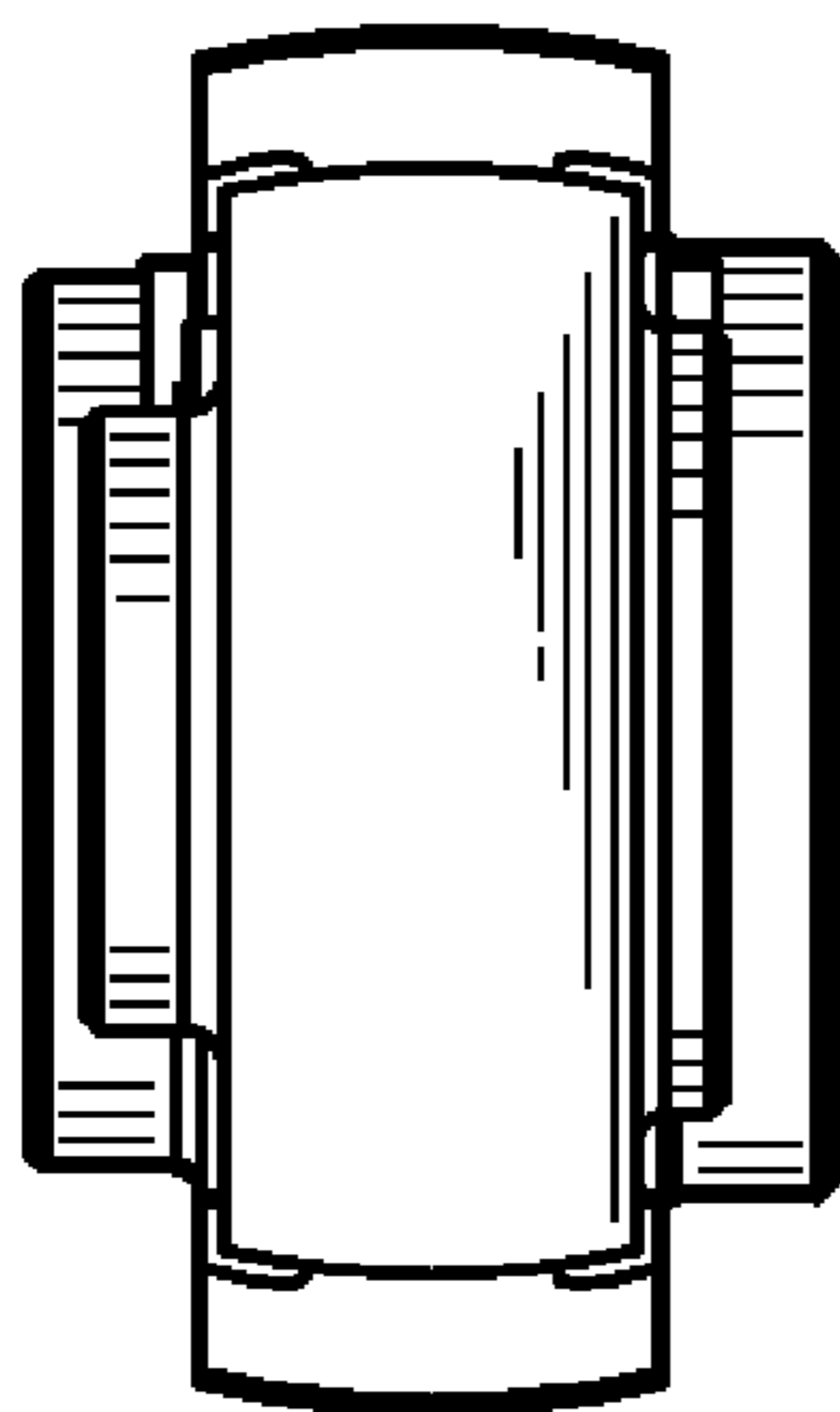

FIG.11

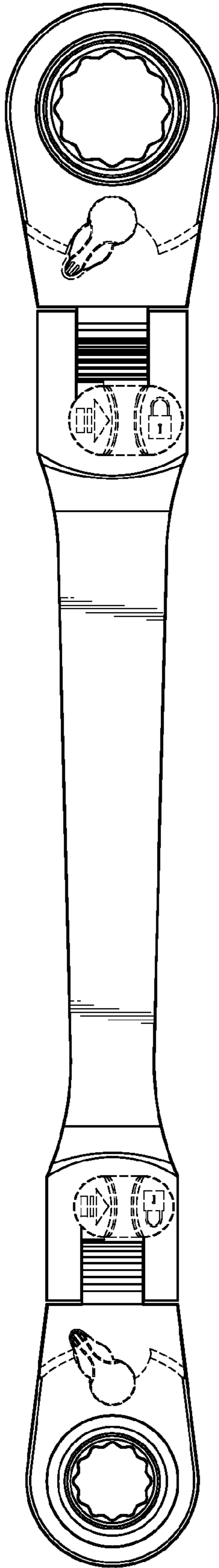

FIG. 13

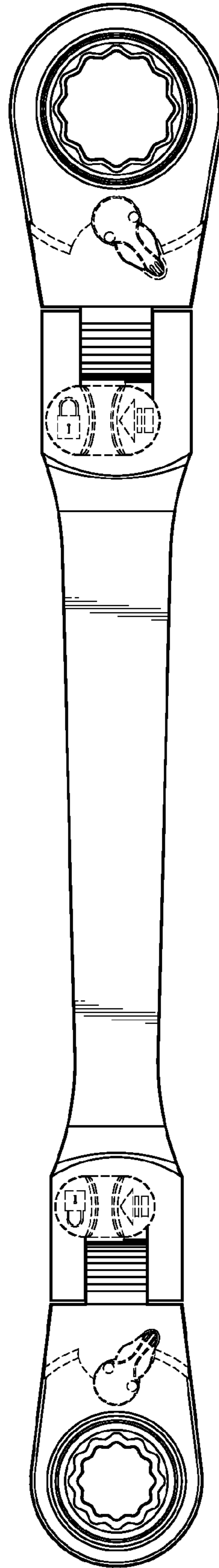

FIG. 14