



US00D559046S

(12) **United States Design Patent**
Onion

(10) **Patent No.:** **US D559,046 S**

(45) **Date of Patent:** **** *Jan. 8, 2008**

- (54) **KNIFE**
- (76) Inventor: **Kenneth J. Onion**, 47 - 501 Hui Kelu St., Kaneohe, HI (US) 96744
- (*) Notice: This patent is subject to a terminal disclaimer.
- (**) Term: **14 Years**
- (21) Appl. No.: **29/257,955**
- (22) Filed: **Apr. 13, 2006**
- (51) **LOC (8) Cl.** **07-03**
- (52) **U.S. Cl.** **D7/649**
- (58) **Field of Classification Search** D4/138;
D7/393, 395, 401.2, 642-646, 649-653, 662-664,
D7/688, 695-696; D8/10, 36, 75, 80, 83,
D8/87, 98, 99, 102, 107, 300, 303; D18/34.9;
D22/118; 30/123.5-123.7, 124-125, 128,
30/142-143, 147-149, 169, 304, 316, 329,
30/340, 342-346, 353, 355, 394
See application file for complete search history.

- D458,511 S * 6/2002 Rorke D7/395
- D460,900 S * 7/2002 Parlowski D7/649
- 6,418,820 B1 7/2002 Lamond et al.
- D462,581 S 9/2002 Parlowski
- D462,582 S 9/2002 Parlowski
- D468,972 S 1/2003 Chen
- D473,430 S * 4/2003 Fedor et al. D7/649
- D479,104 S * 9/2003 Onion D7/649
- D482,426 S 11/2003 Taylor et al.
- D483,625 S 12/2003 Chien
- D483,643 S * 12/2003 Chien D8/107
- D486,718 S * 2/2004 Goddert D8/107
- D494,426 S * 8/2004 Prokop D7/652
- D497,522 S 10/2004 Reichenbach et al.
- D498,985 S * 11/2004 Kerr et al. D7/649
- D507,469 S * 7/2005 Prokop D8/107
- D513,927 S * 1/2006 Chen D7/395
- D524,121 S * 7/2006 Loeb D7/649

(56) **References Cited**

U.S. PATENT DOCUMENTS

- 2,059,414 A * 11/1936 Taylor 30/355
- 2,651,839 A 9/1953 Folland
- D192,916 S 5/1962 Zorn
- D201,377 S 6/1965 Furness
- D218,216 S 7/1970 Hopcraft et al.
- D220,930 S 6/1971 Arlett
- D248,039 S 5/1978 Hoffman
- D287,042 S * 12/1986 Hoffman D22/118
- D302,092 S * 7/1989 Cohen et al. D7/650
- 5,081,770 A * 1/1992 Fierthaler 30/355
- D366,515 S 1/1996 Thompson
- 5,528,834 A 6/1996 Seber et al.
- D372,635 S * 8/1996 Gebhardt D7/401.2
- 5,791,055 A * 8/1998 Mangol 30/340
- D425,365 S 5/2000 Chien
- D439,491 S * 3/2001 Falt D8/98
- D440,125 S * 4/2001 Barker, II D7/651
- 6,213,055 B1 4/2001 Willinger et al.
- D447,015 S * 8/2001 Chien D7/649
- D448,253 S 9/2001 Staib, Jr. et al.
- D458,510 S * 6/2002 Haataja D7/395

OTHER PUBLICATIONS

The UK Patent Office—Designs Register Enquiry, Designs Full Detail for UK Registered Design Patent No. 3004234, granted Sep. 17, 2002, <http://webdb4patent.gov.uk/designs?csbdesign=3004234>, download date of Jul. 25, 2006.

* cited by examiner

Primary Examiner—Caron D. Veynar
Assistant Examiner—Ricky Pham
(74) *Attorney, Agent, or Firm*—Seed IP Law Group PLLC

(57) **CLAIM**

The ornamental design for the knife, as shown.

DESCRIPTION

FIG. 1 is a back-side perspective view of a knife showing my new design.
FIG. 2 is a front elevational view thereof.
FIG. 3 is a rear elevational view thereof.
FIG. 4 is a top plan view thereof.
FIG. 5 is a left side elevational view thereof.
FIG. 6 is a bottom plan view thereof; and,
FIG. 7 is a right side elevational view thereof.

1 Claim, 3 Drawing Sheets

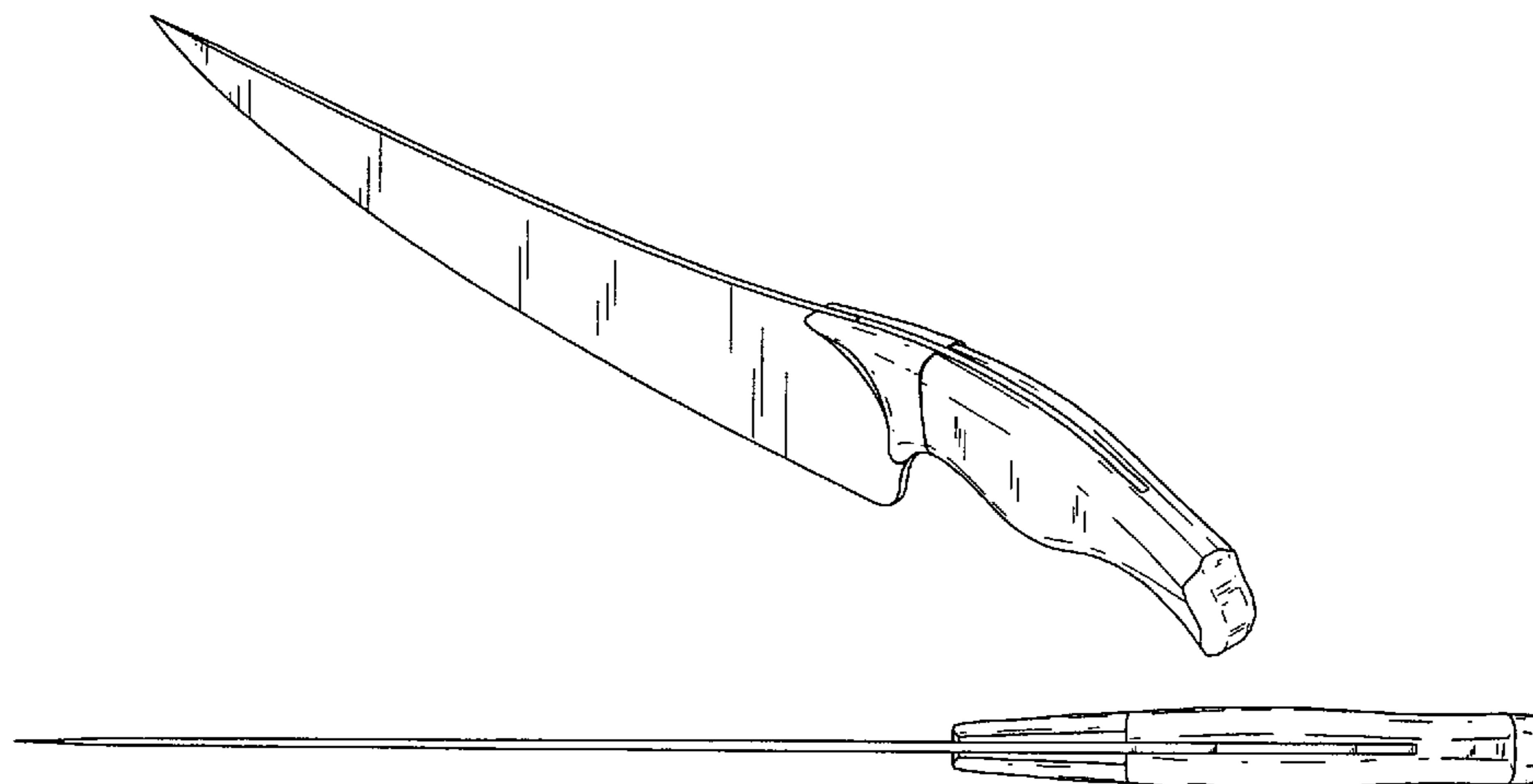

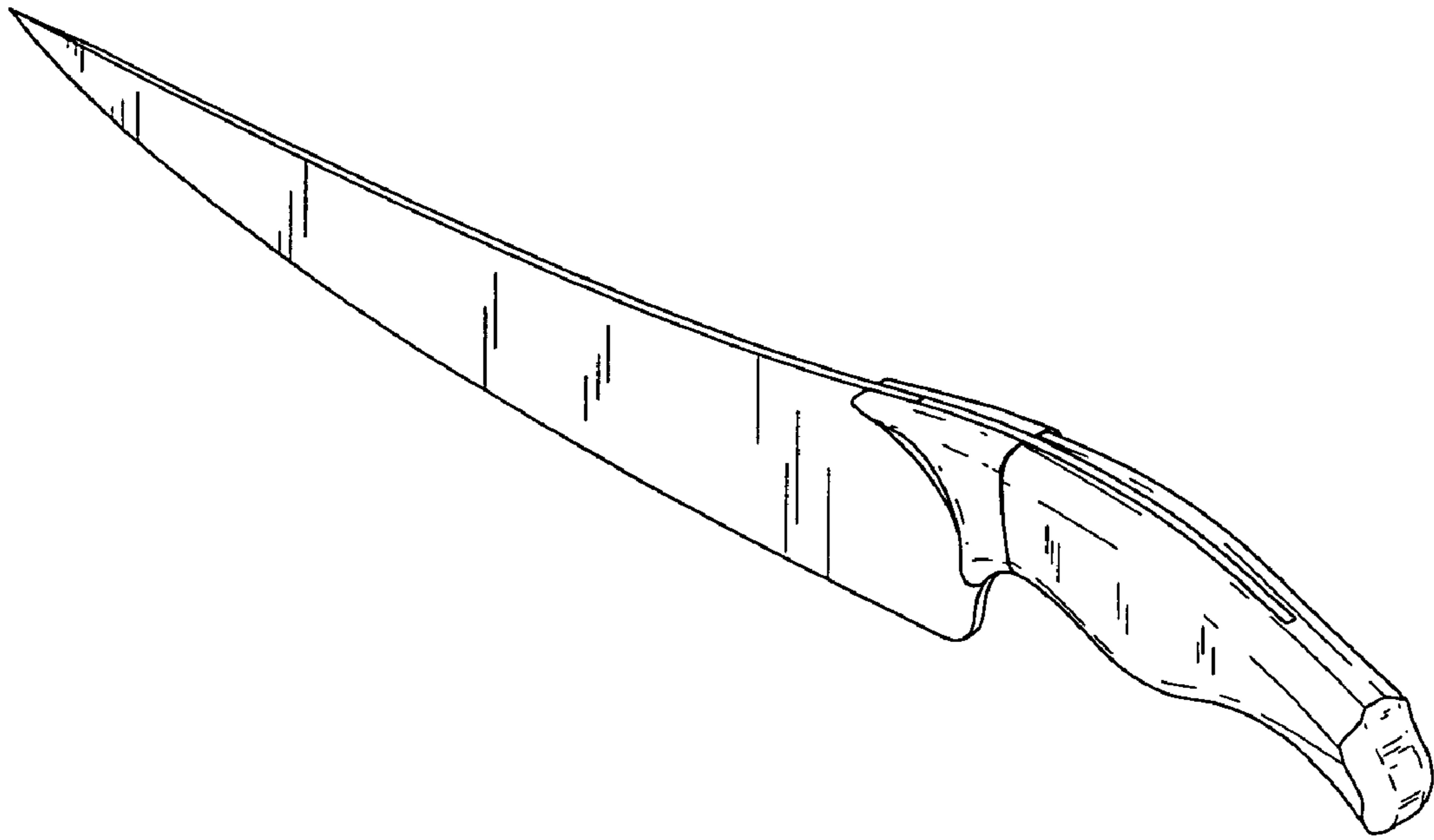

FIG. 1

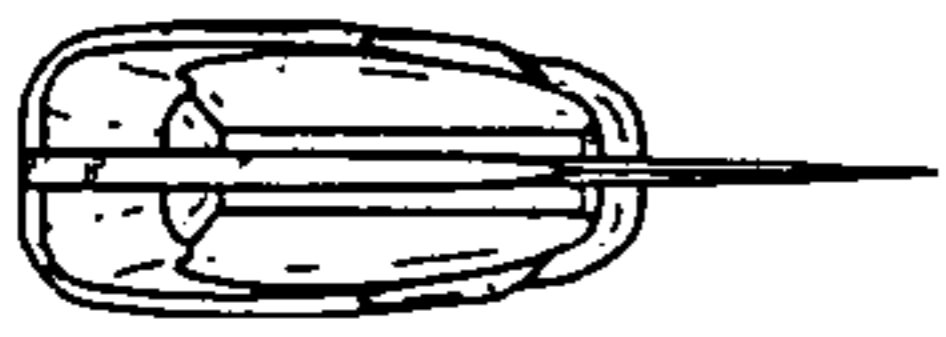

FIG. 2



FIG. 3

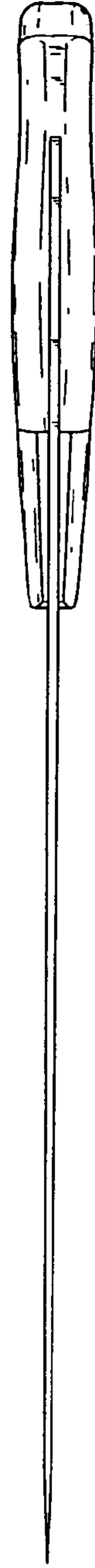

FIG. 4

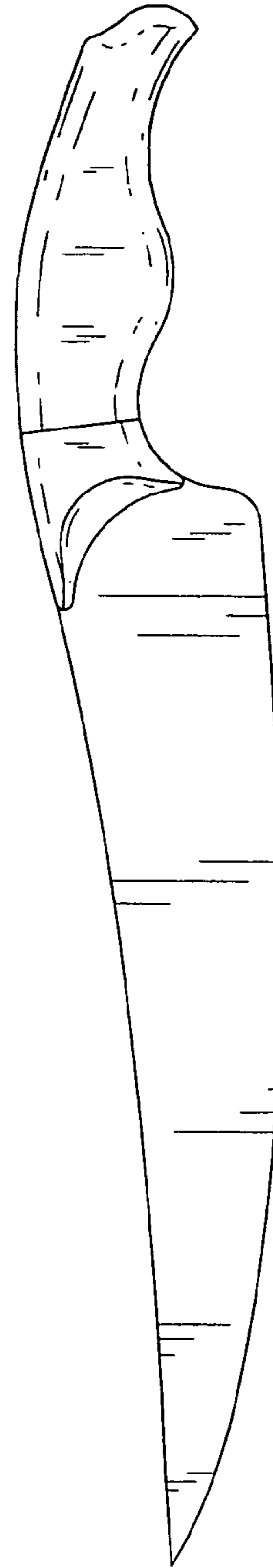

FIG. 5

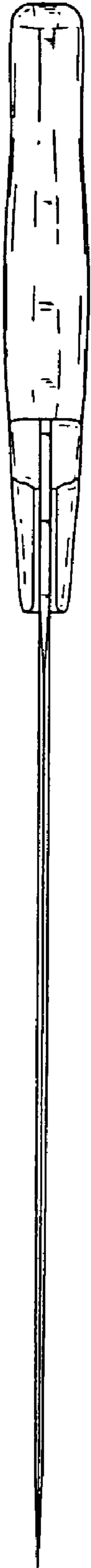

FIG. 6

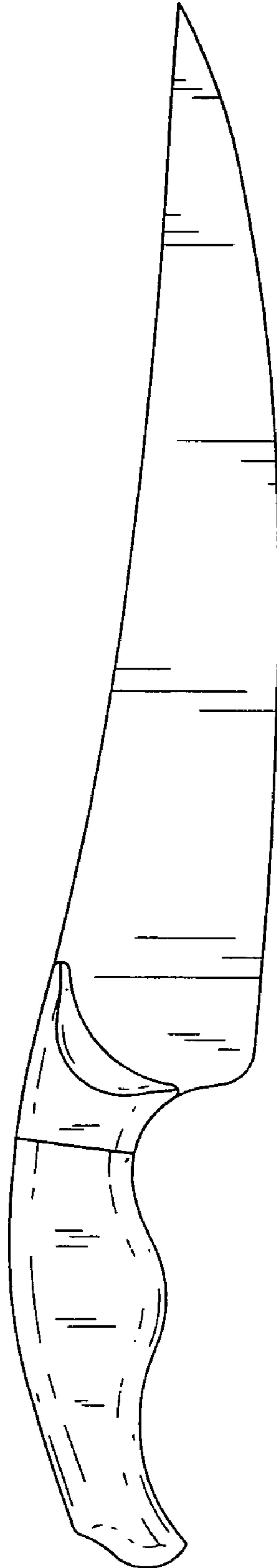

FIG. 7