



US00D559008S

(12) **United States Design Patent**
Knight

(10) **Patent No.:** **US D559,008 S**

(45) **Date of Patent:** **** Jan. 8, 2008**

(54) **STAND**

(75) Inventor: **Nancy L. Knight**, San Rafael, CA (US)

(73) Assignee: **Smith & Hawkins, Ltd.**, Novato, CA (US)

(**) Term: **14 Years**

(21) Appl. No.: **29/274,041**

(22) Filed: **Mar. 21, 2007**

Related U.S. Application Data

(62) Division of application No. 29/245,300, filed on Dec. 20, 2005, now Pat. No. Des. 542,054.

(51) **LOC (8) Cl.** **11-02**

(52) **U.S. Cl.** **D6/403**

(58) **Field of Classification Search** D6/403,
D6/404, 556-558; D7/515, 518, 521, 523,
D7/549, 554.3, 562, 564; D11/143-149,
D11/152-156; D19/77, 80-82, 84, 85; D26/9,
D26/16; 47/32.7, 33, 39, 41.01, 41.1, 41.12-41.15,
47/44-47, 65.5, 66.1, 66.6, 66.7, 67-71
See application file for complete search history.

(56) **References Cited**

U.S. PATENT DOCUMENTS

D63,046 S * 9/1923 Stuck D6/403

D81,436 S * 6/1930 Dew et al. D6/403
4,102,323 A * 7/1978 Pritz D11/143
D372,137 S * 7/1996 Hollinger D6/403
D434,247 S * 11/2000 Rosenberg D6/403
D478,735 S * 8/2003 Sellers D6/403
D497,494 S * 10/2004 Tseng D6/403

* cited by examiner

Primary Examiner—Robert M. Spear

Assistant Examiner—Garth Rademaker

(74) *Attorney, Agent, or Firm*—Manatt, Phelps and Phillips

(57) **CLAIM**

The ornamental design for a stand, as shown and described.

DESCRIPTION

FIG. 1 is a perspective view of a stand according to the present invention;

FIG. 2 is a front elevation view thereof;

FIG. 3 is a rear elevation view thereof;

FIG. 4 is a right side elevation view thereof;

FIG. 5 is a top plan view thereof; and,

FIG. 6 is a bottom plan view thereof.

1 Claim, 5 Drawing Sheets

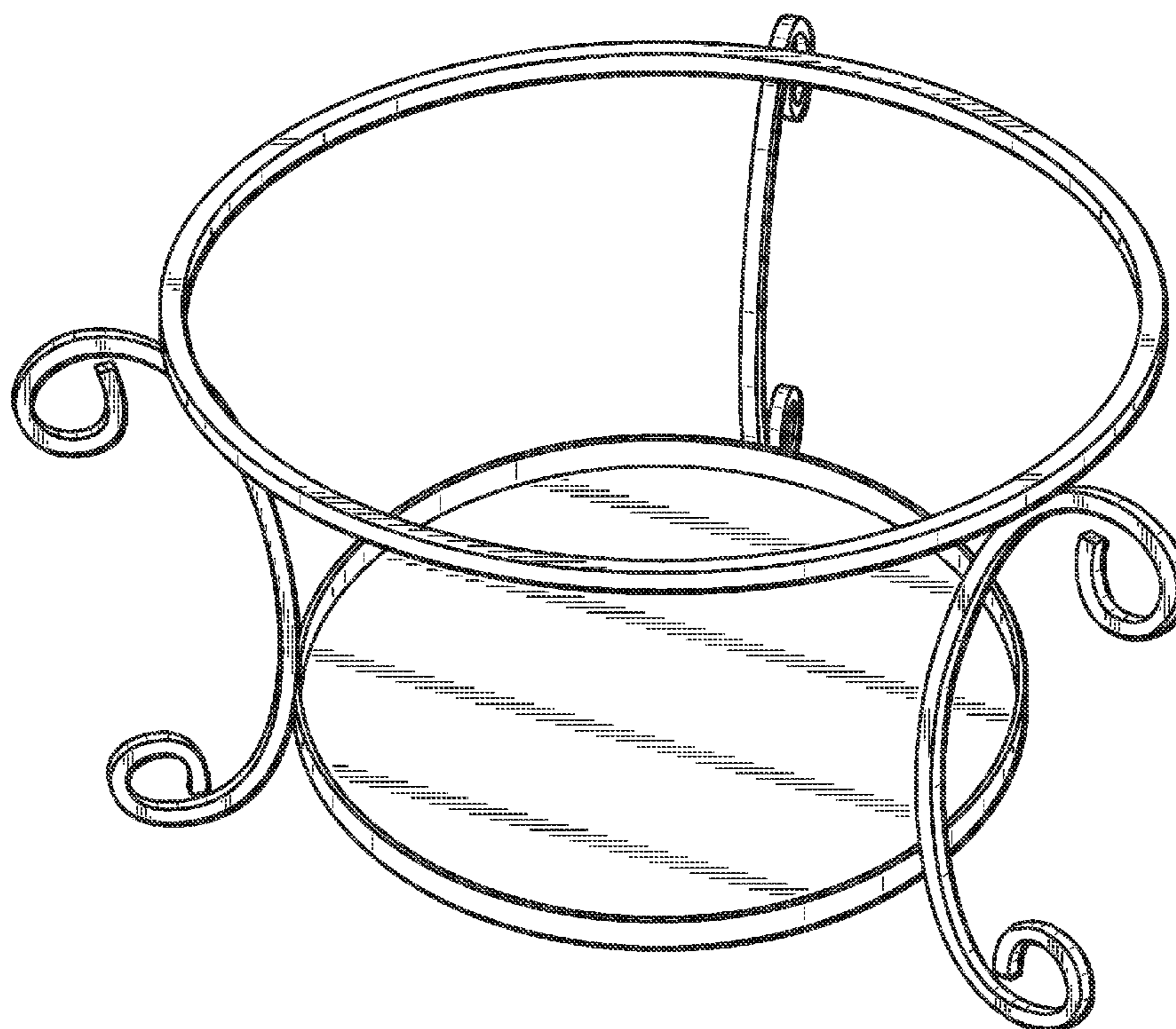

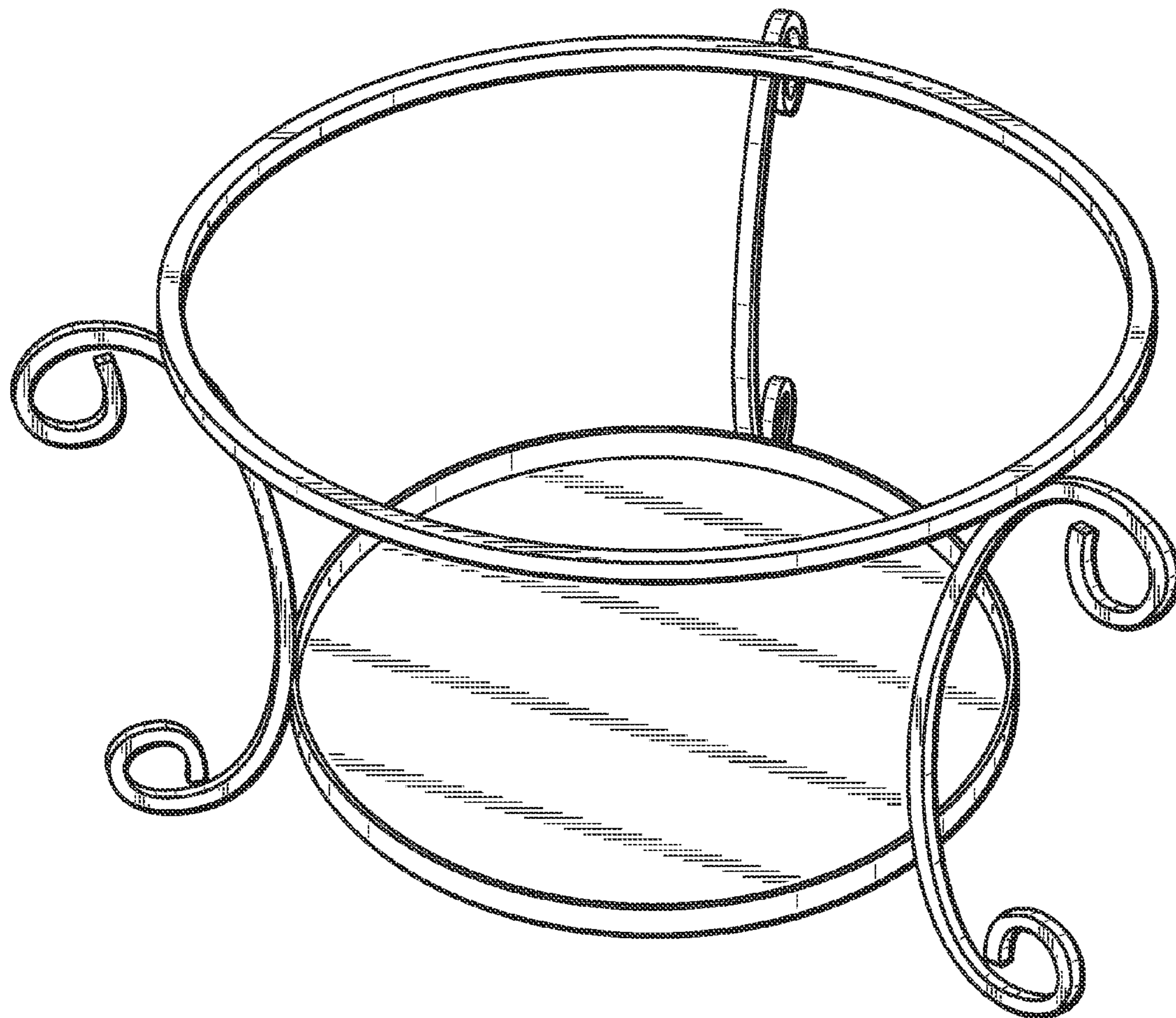

FIG. 1

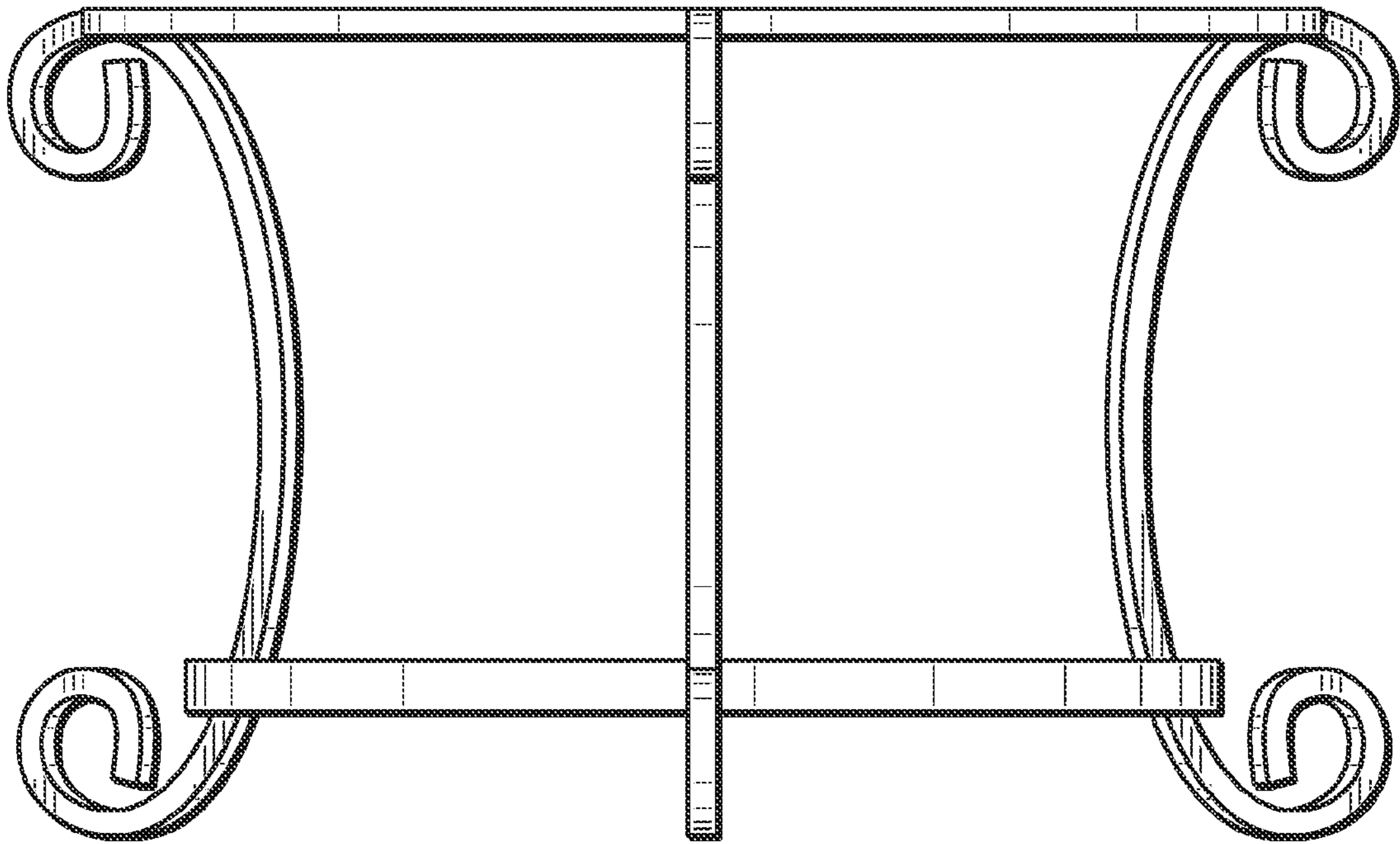

FIG. 2

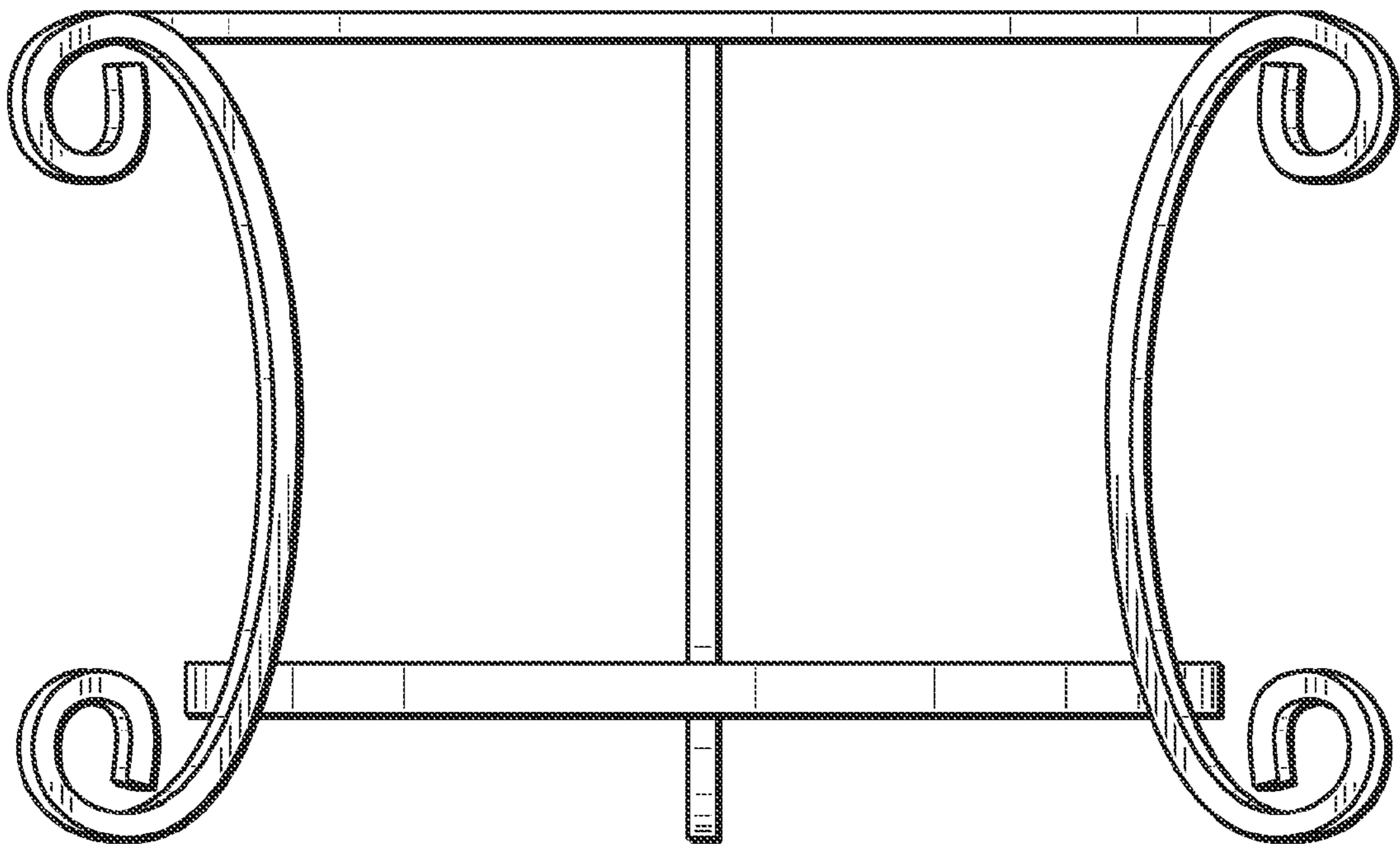

FIG. 3

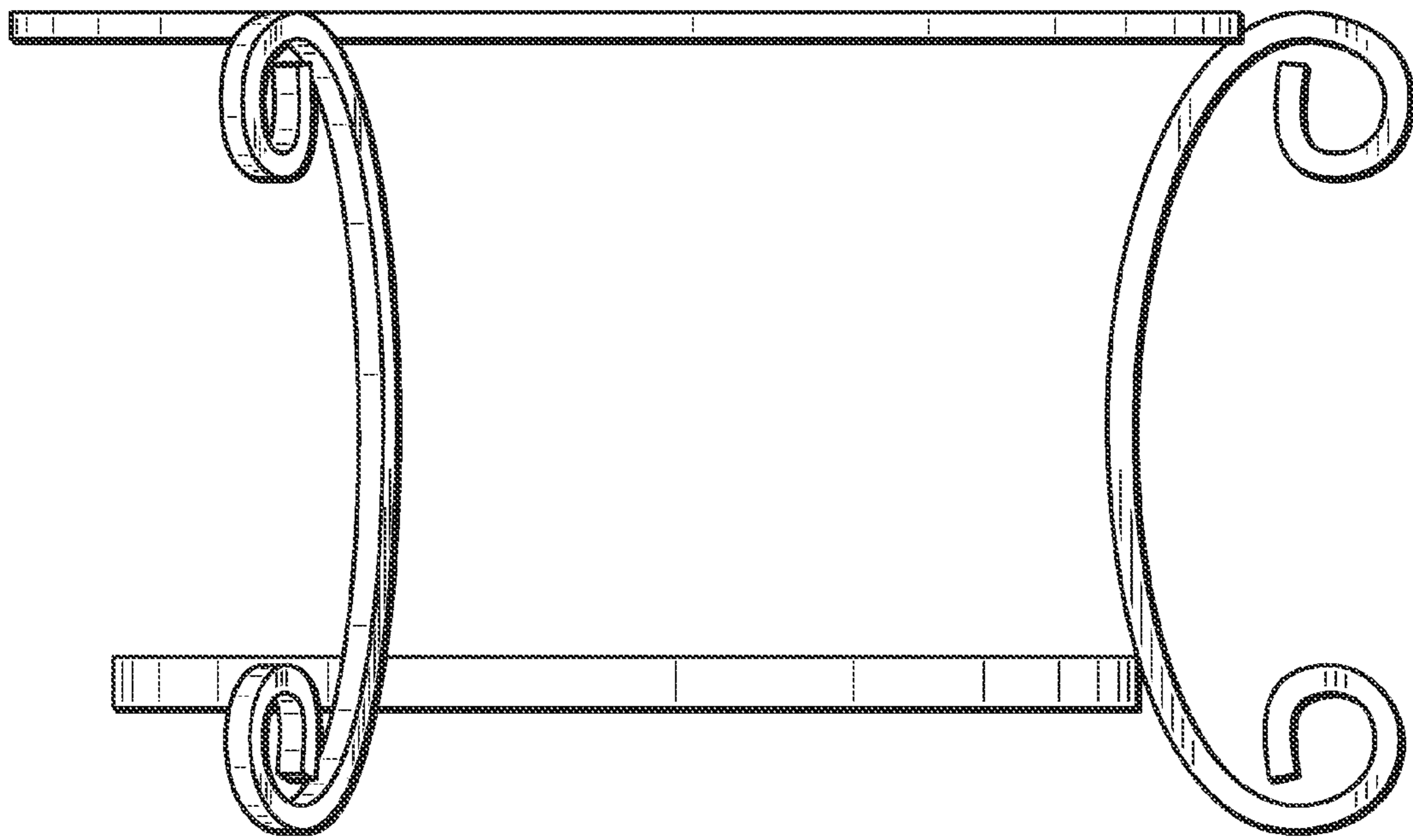

FIG. 4

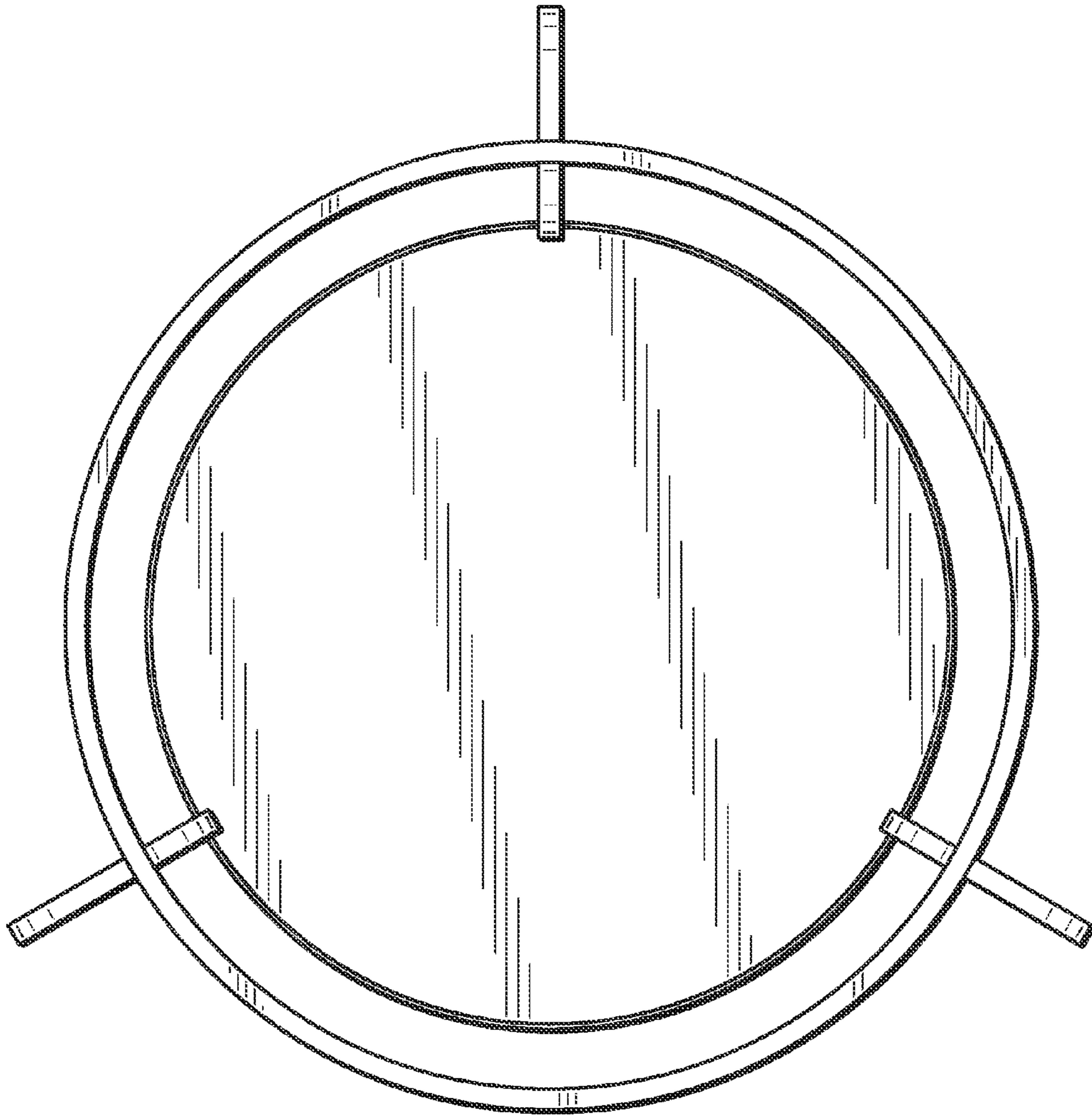

FIG. 5

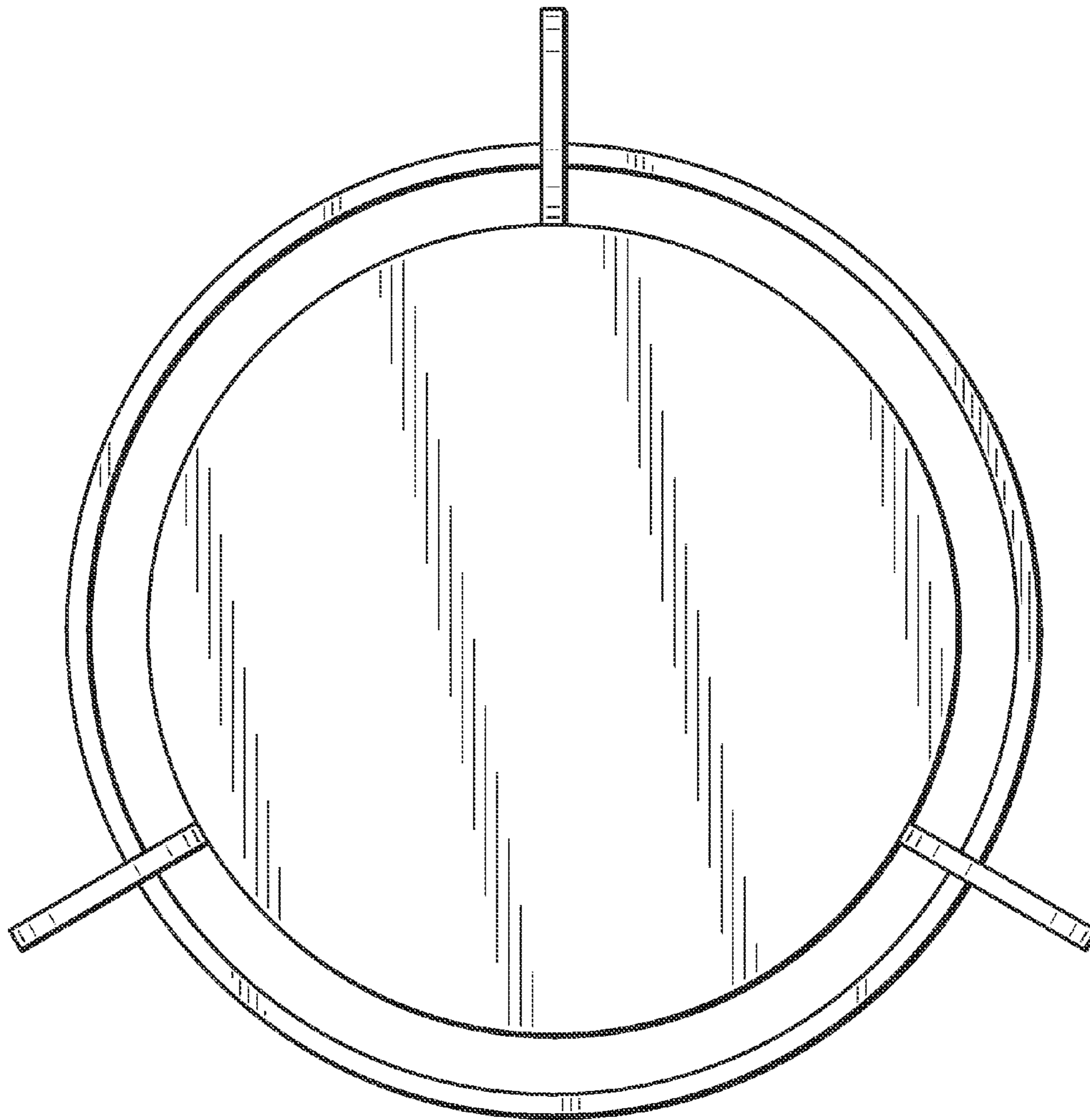

FIG. 6