



US00D559005S

(12) **United States Design Patent**
Ricci

(10) **Patent No.:** **US D559,005 S**
(45) **Date of Patent:** **** Jan. 8, 2008**

(54) **SEAT**

(75) Inventor: **Luca Ricci**, Bertinoro-Fc (IT)
(73) Assignee: **DeCoro Limited**, Hong Kong (HK)
(**) Term: **14 Years**

(21) Appl. No.: **29/262,274**
(22) Filed: **Jun. 28, 2006**

(30) **Foreign Application Priority Data**
Apr. 21, 2006 (CN) 2006 3 0014217
(51) **LOC (8) Cl.** **06-01**
(52) **U.S. Cl.** **D6/381**
(58) **Field of Classification Search** D6/334-336,
D6/361, 371, 381, 500-502, 492; 297/445.1,
297/446.1, 232, 248; 5/12.1
See application file for complete search history.

(56) **References Cited**

U.S. PATENT DOCUMENTS

D487,992 S * 4/2004 Natuzzi D6/381
D493,631 S * 8/2004 Nastri D6/381
D528,817 S * 9/2006 Nastri D6/381
D530,111 S * 10/2006 Nastri D6/381

OTHER PUBLICATIONS

Natuzzi sofa #778, International Home Furnishings Market, High Point, NC, Oct. 1990, 1 pg.*

* cited by examiner

Primary Examiner—Sandra Snapp
(74) *Attorney, Agent, or Firm*—Ropes & Gray LLP

(57) **CLAIM**

I claim the ornamental design for a seat, as shown and described.

DESCRIPTION

FIG. 1 is a front view of one embodiment of my new seat design in the form of a sofa.

FIG. 2 is a side view of this embodiment of the seat.

FIG. 3 is a perspective view of this embodiment of the seat.

FIG. 4 is a rear view of this embodiment of the seat.

FIG. 5 is a side view of this embodiment of the seat.

FIG. 6 is a top view of this embodiment of the seat.

FIG. 7 is a front view of a further embodiment of my new seat design in the form of a chair.

FIG. 8 is a side view of this further embodiment of the seat.

FIG. 9 is a perspective view of this further embodiment of the seat.

FIG. 10 is a rear view of this further embodiment of the seat.

FIG. 11 is a side view of this further embodiment of the seat.

FIG. 12 is a top view of this further embodiment of the seat; and,

FIG. 13 is a perspective view of this further embodiment of the seat, showing the seat in a reclined position.

As shown in the drawings herein, broken (dotted) lines are used to indicate stitching, and dashed lines in FIG. 13 are used to show mechanical elements which are not part of the design.

1 Claim, 13 Drawing Sheets

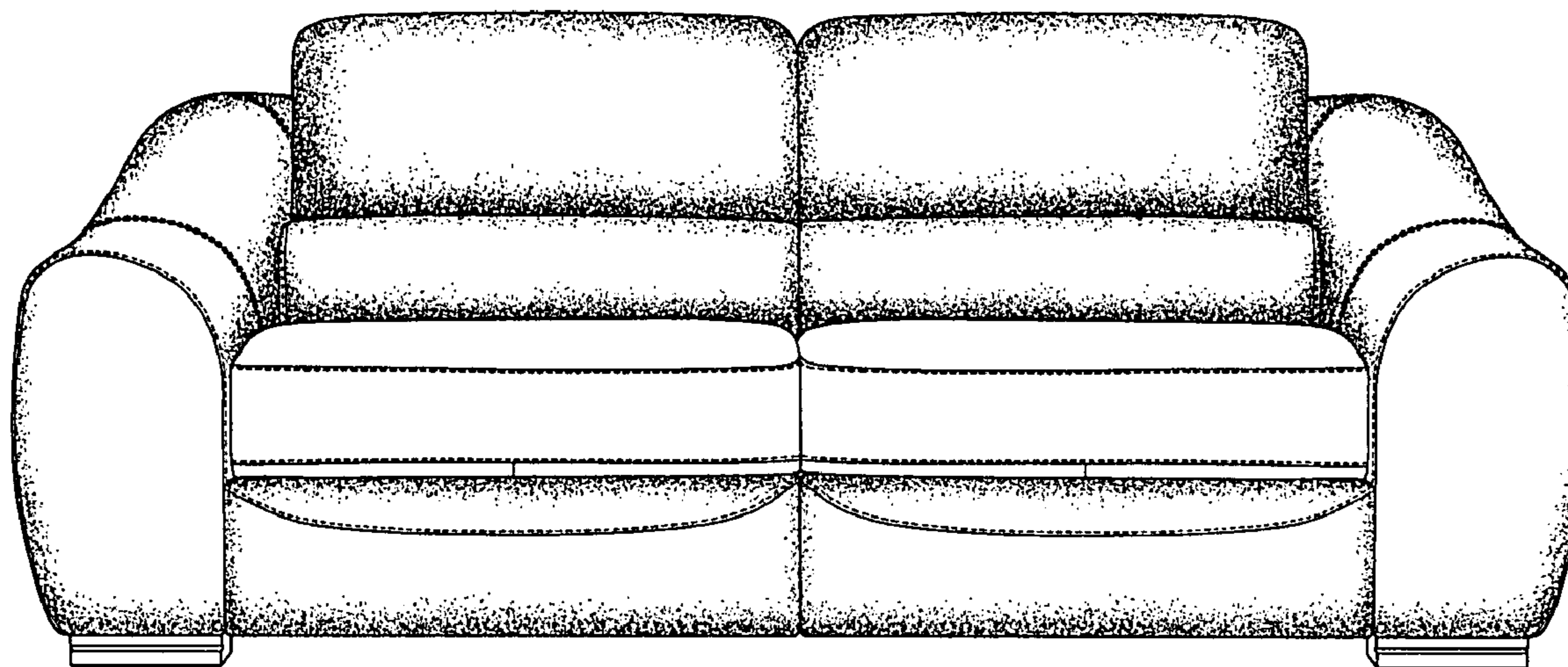

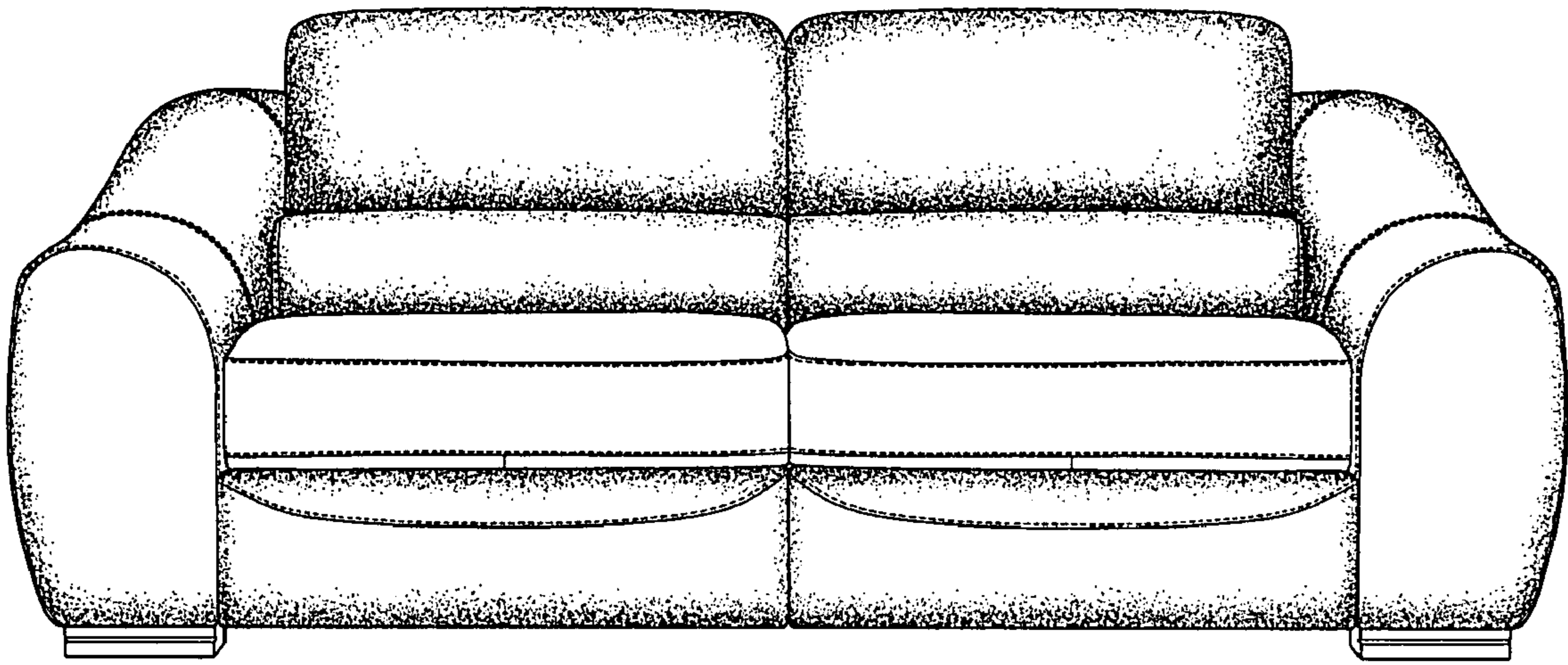

FIGURE 1

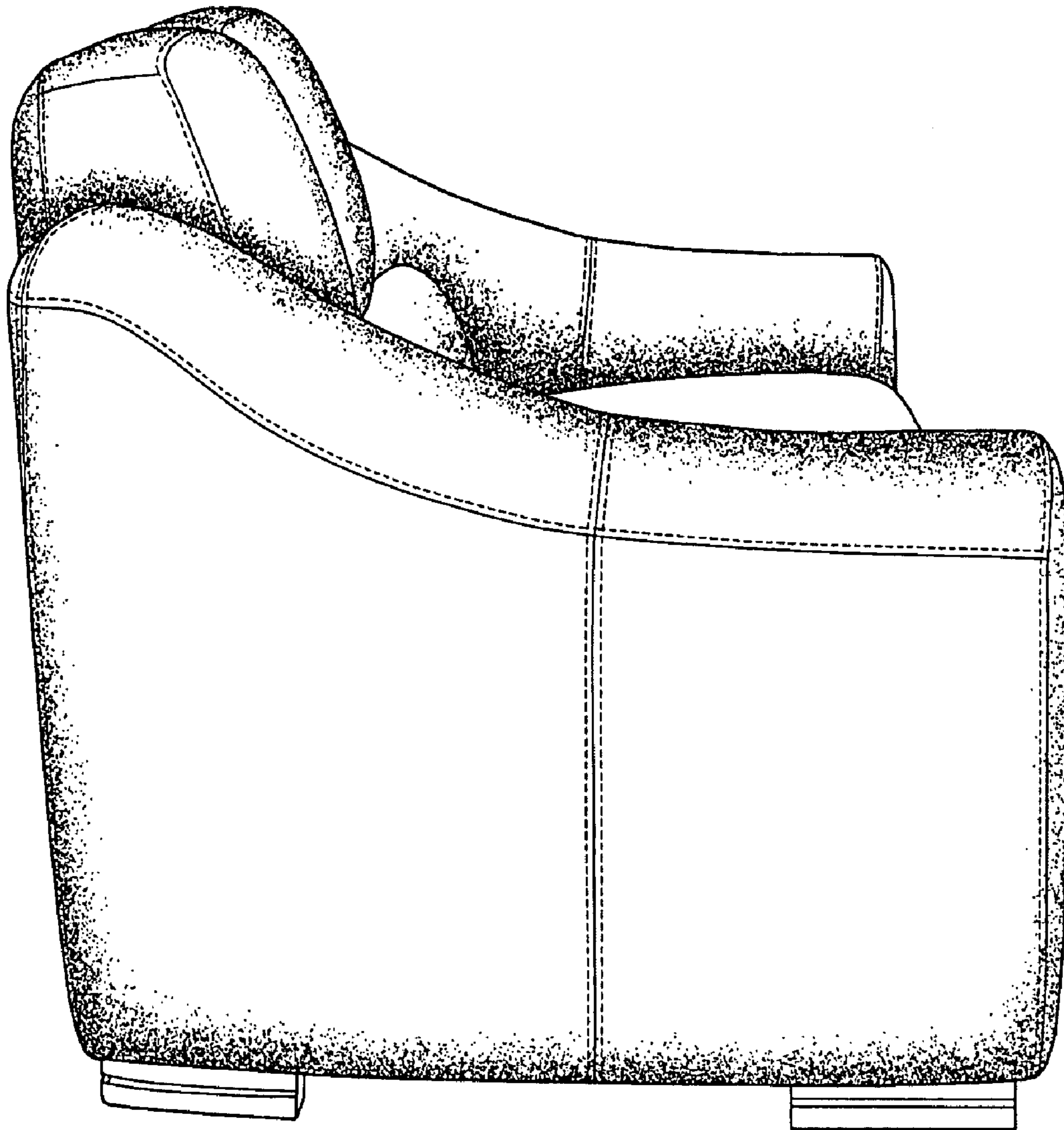

FIGURE 2

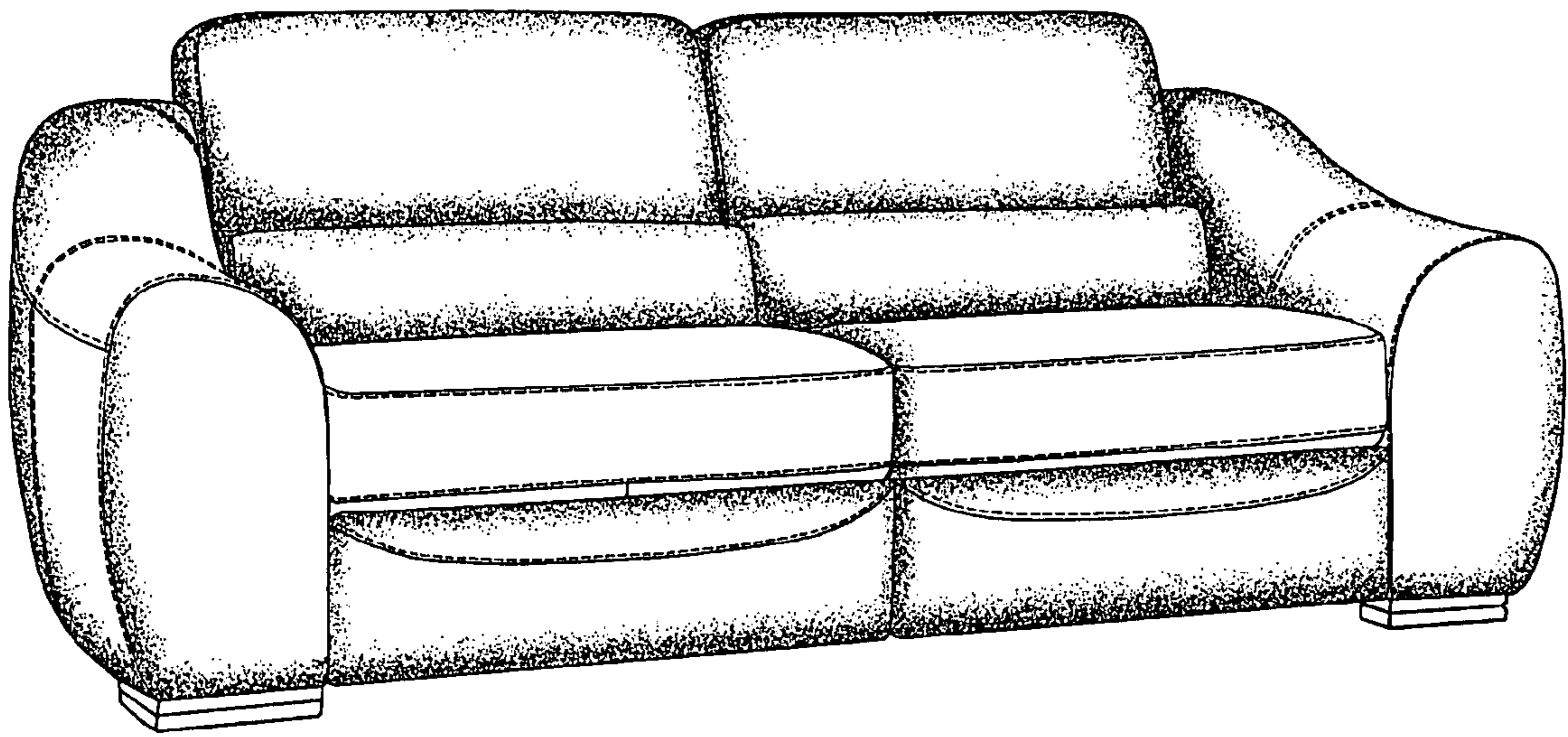

FIGURE 3

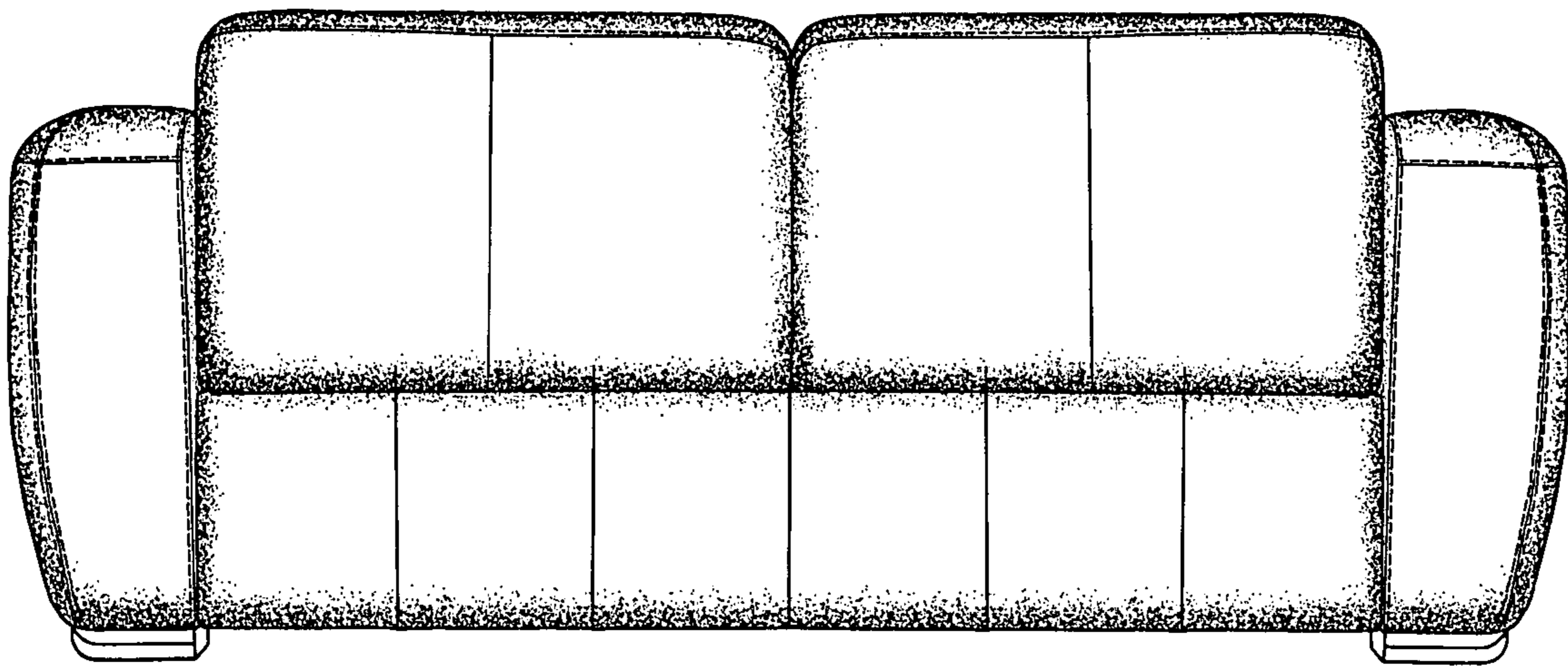

FIGURE 4

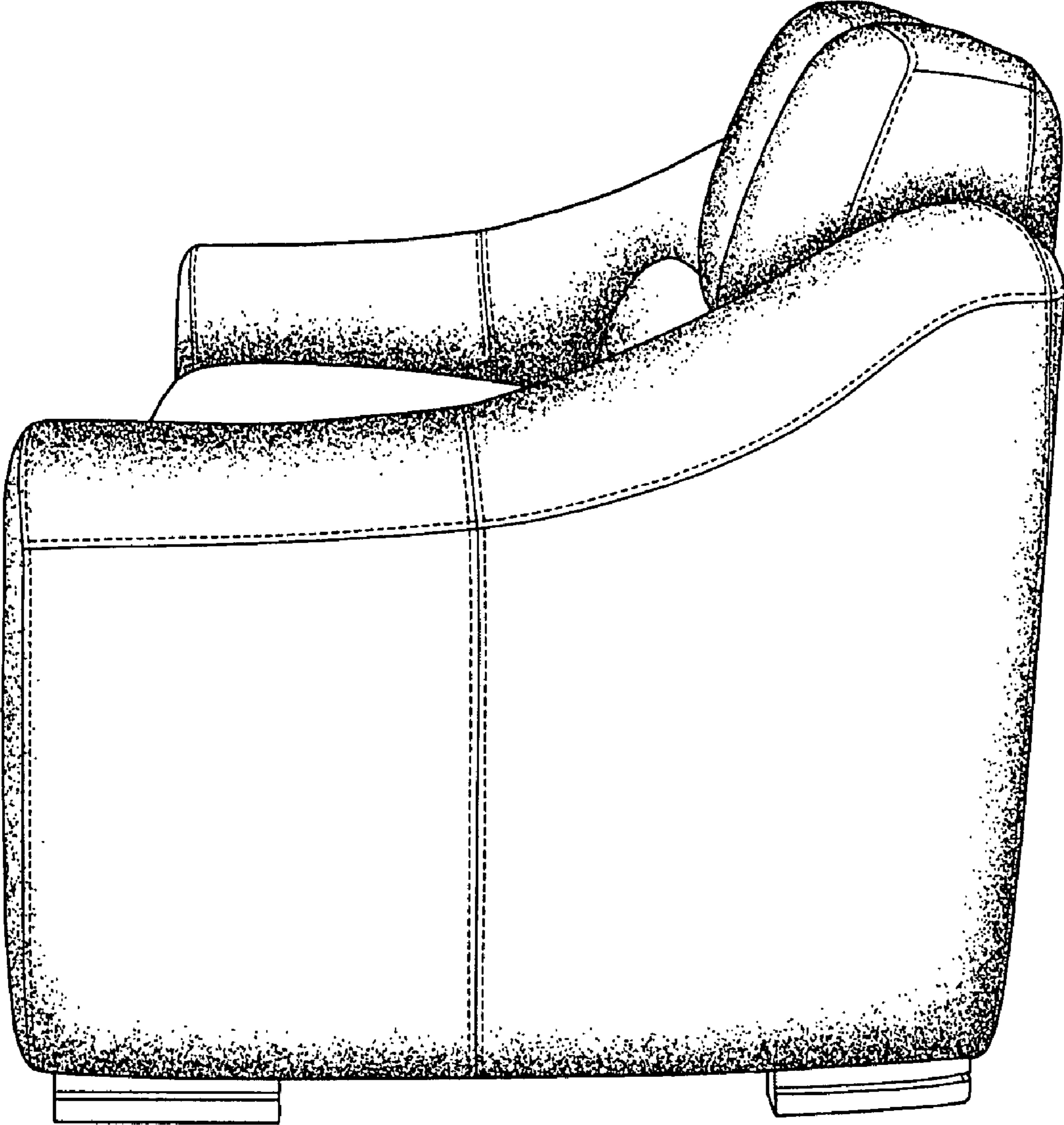

FIGURE 5

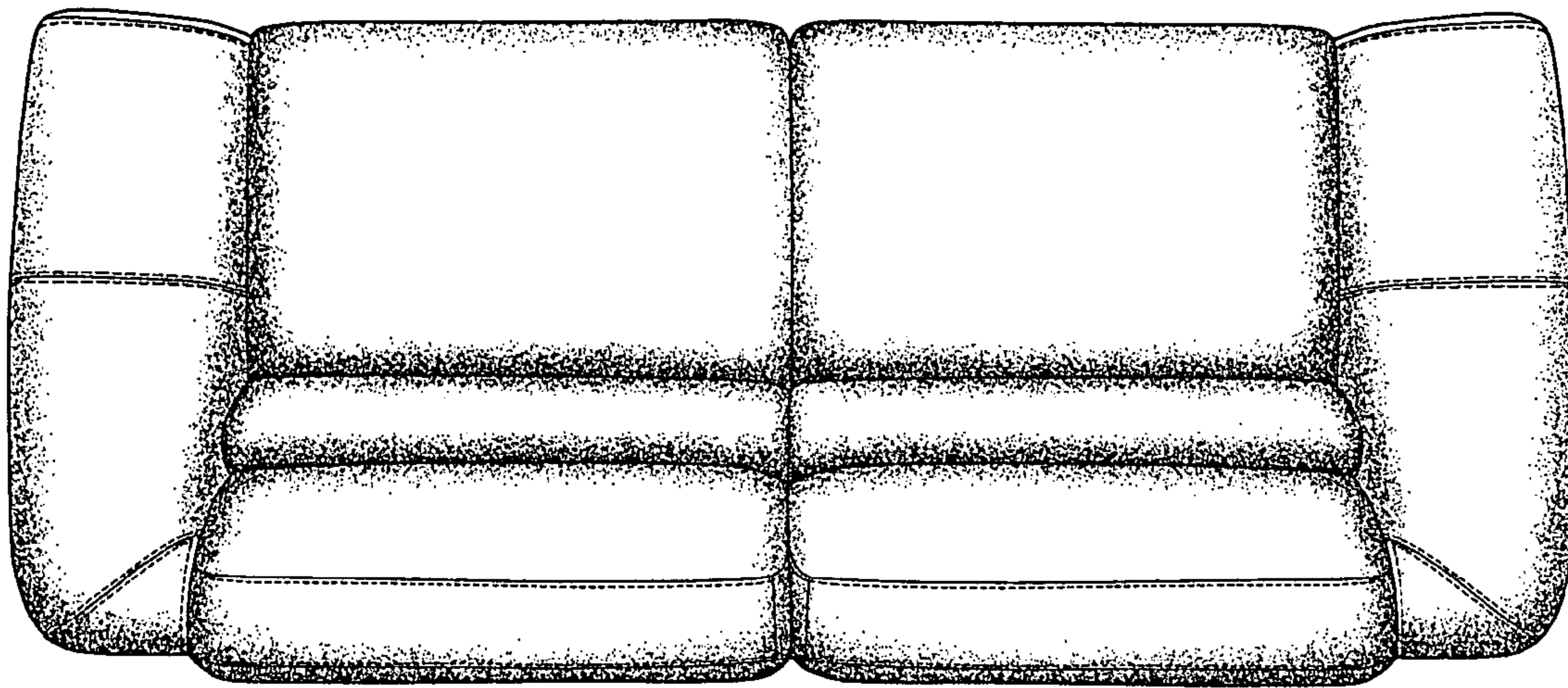

FIGURE 6

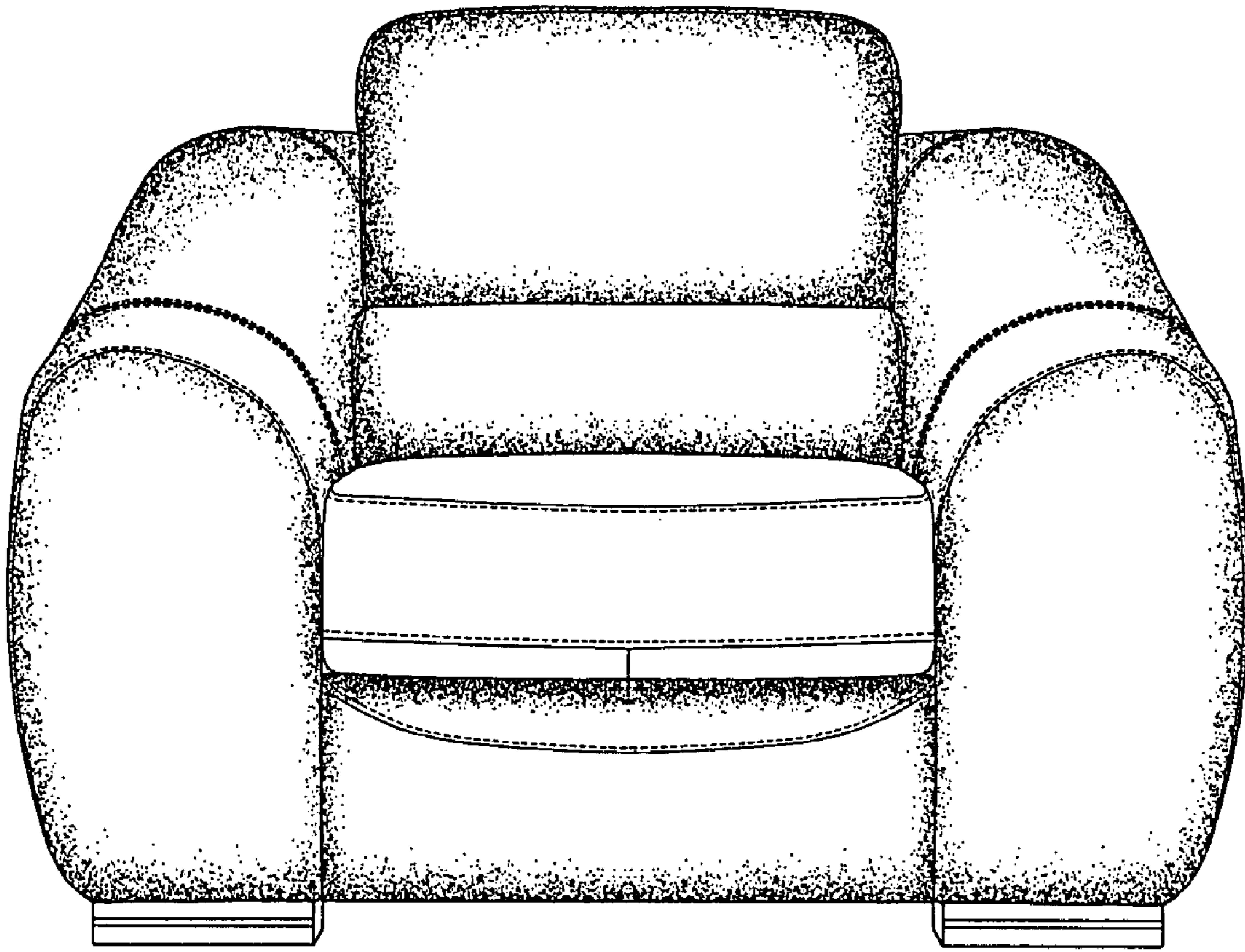

FIGURE 7

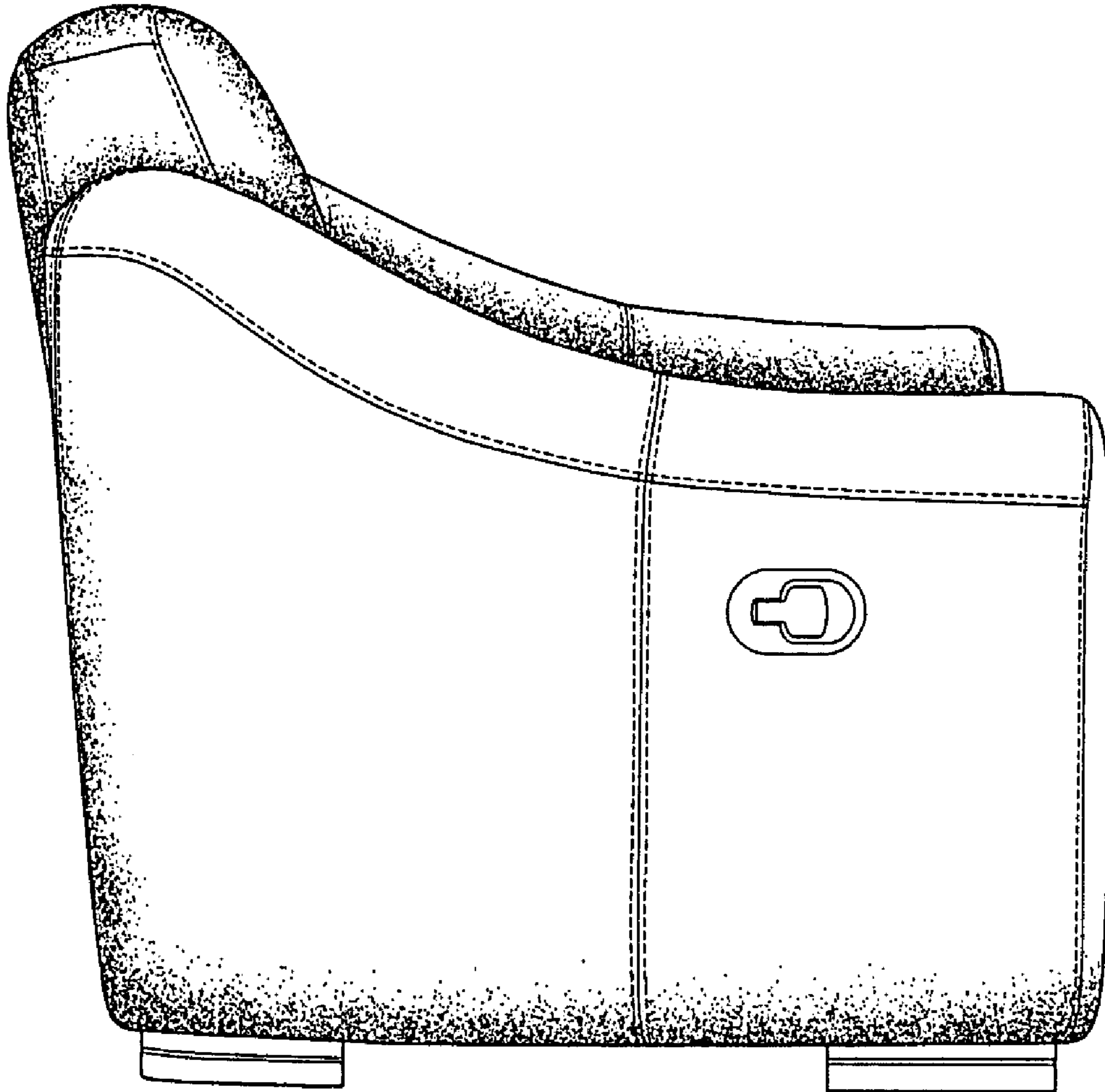

FIGURE 8

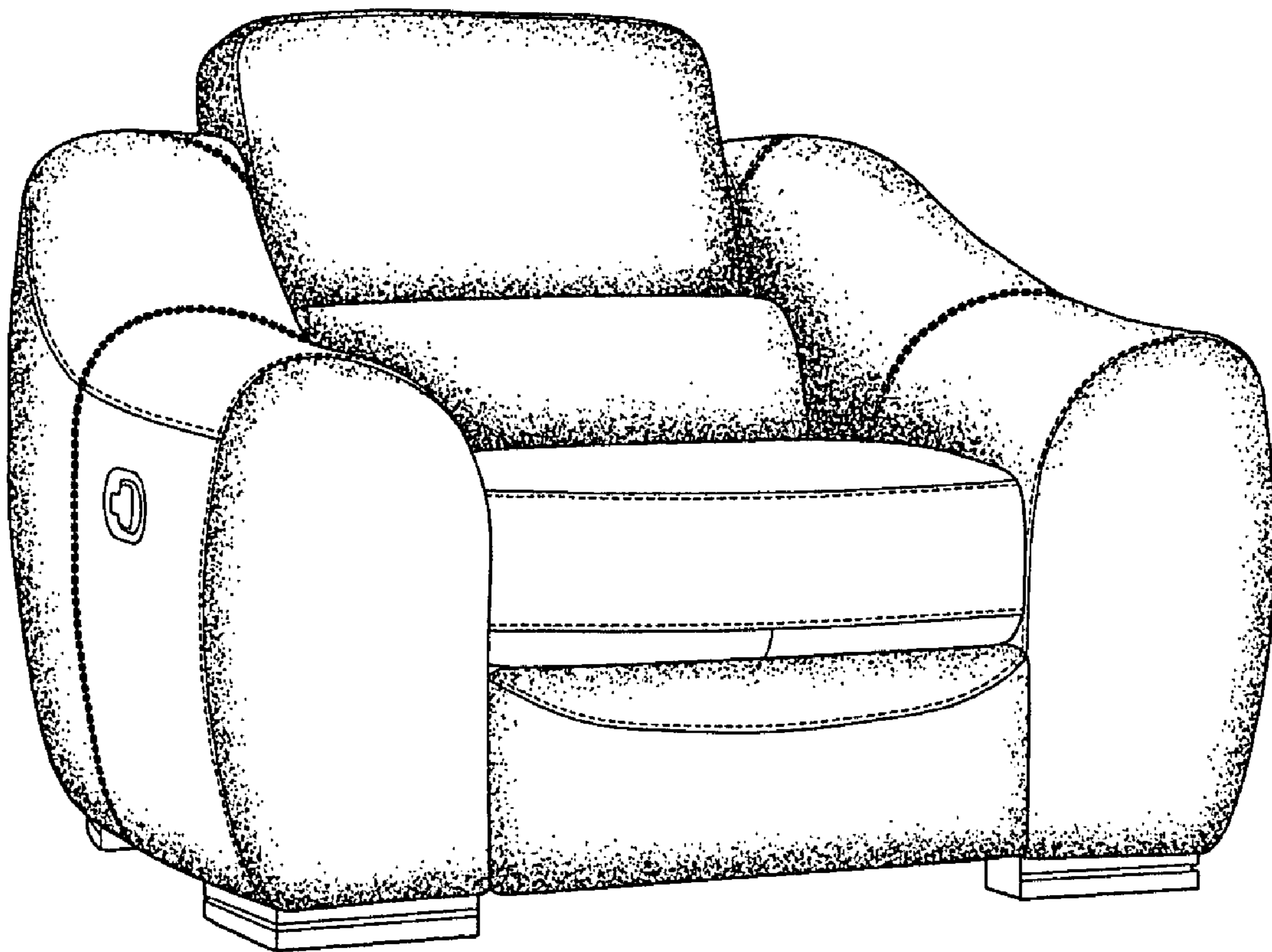

FIGURE 9

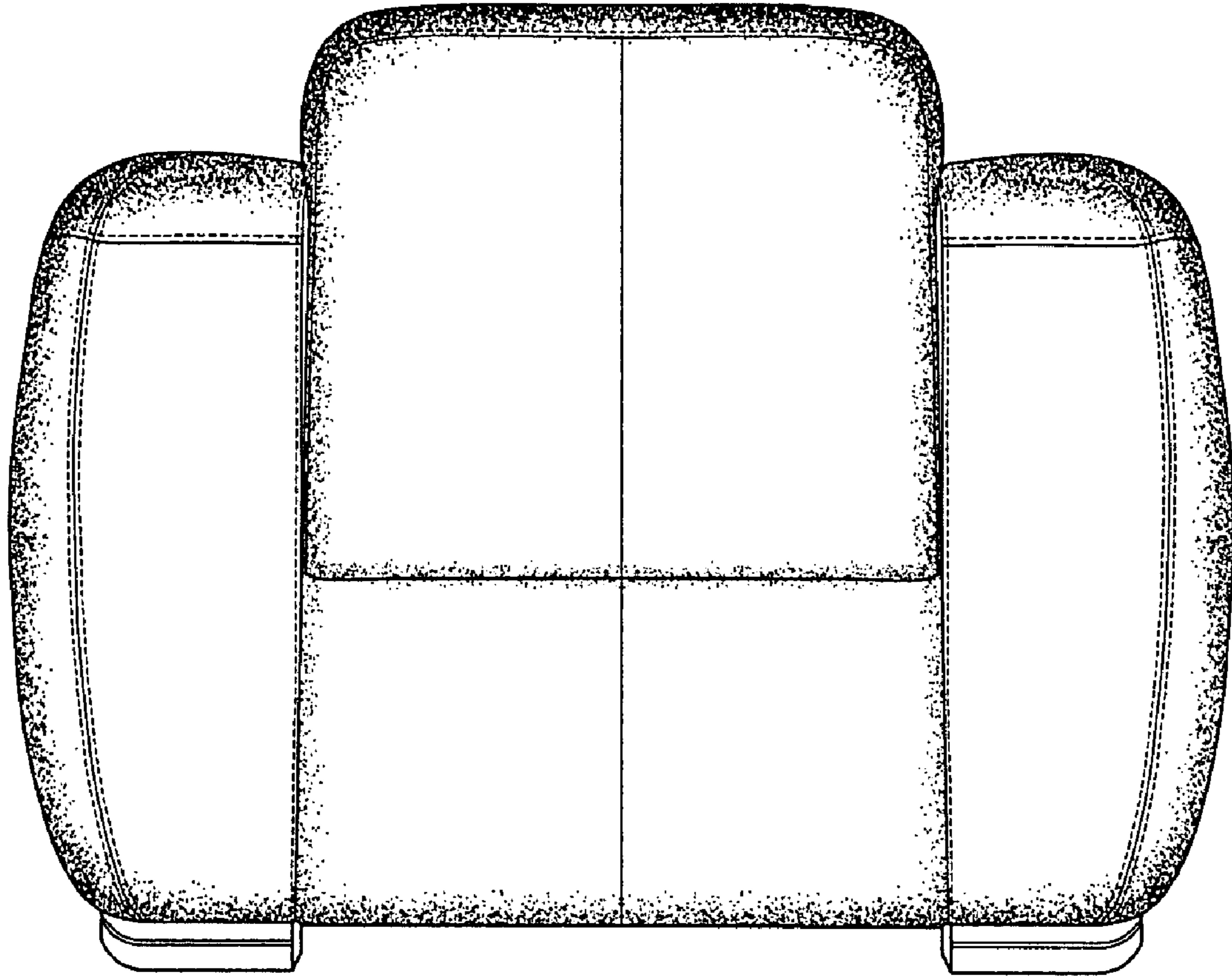

FIGURE 10

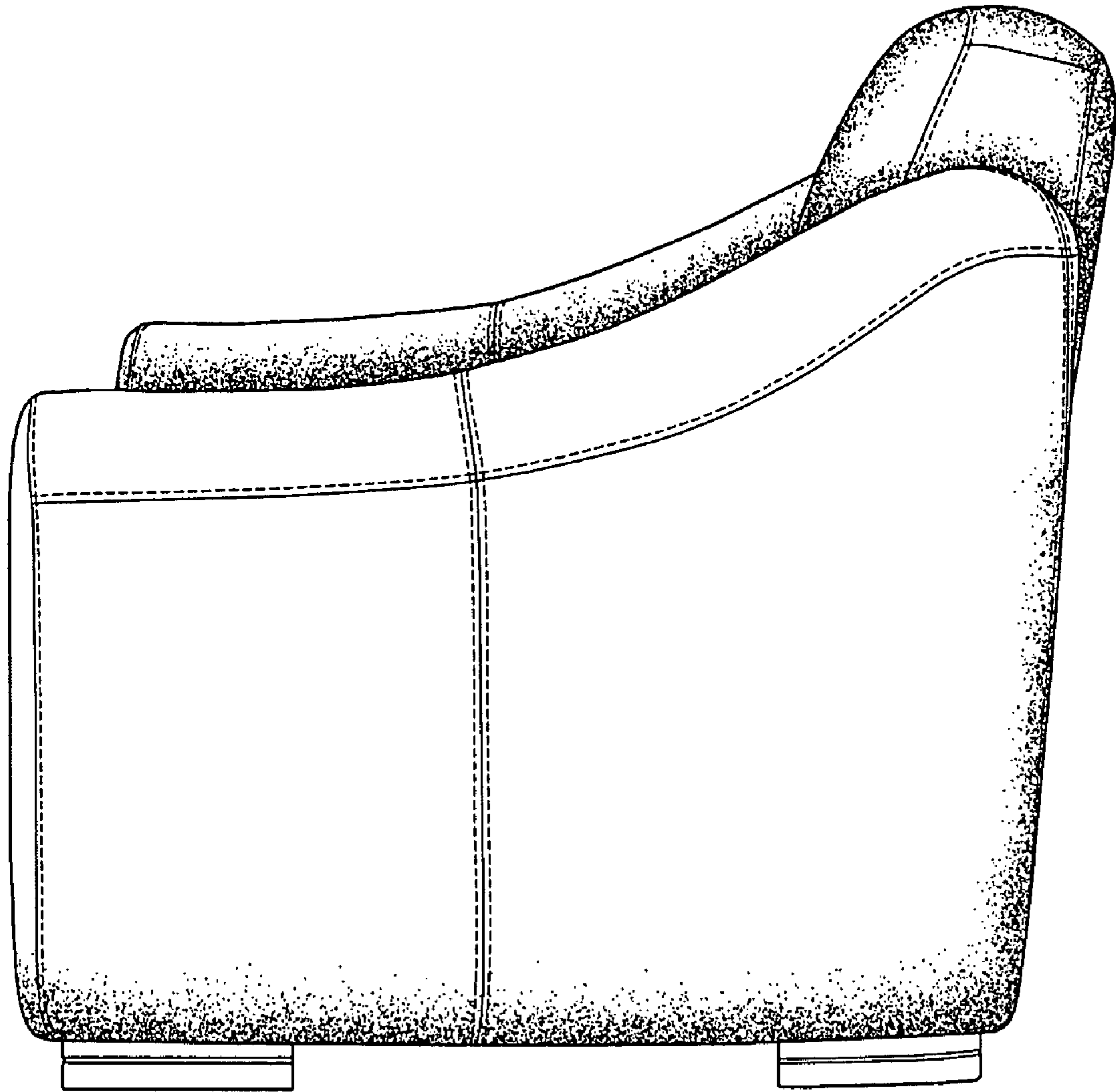

FIGURE 11

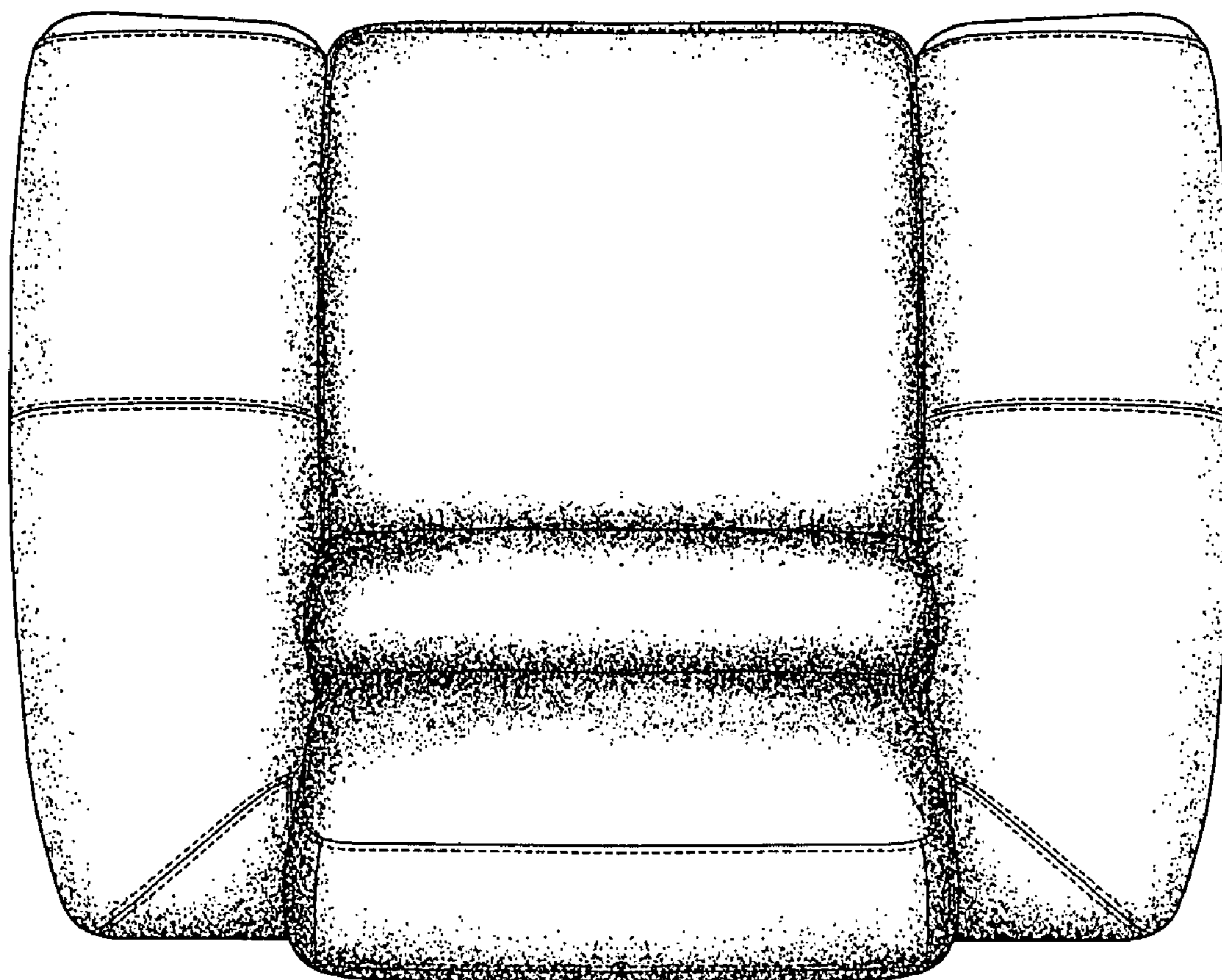

FIGURE 12

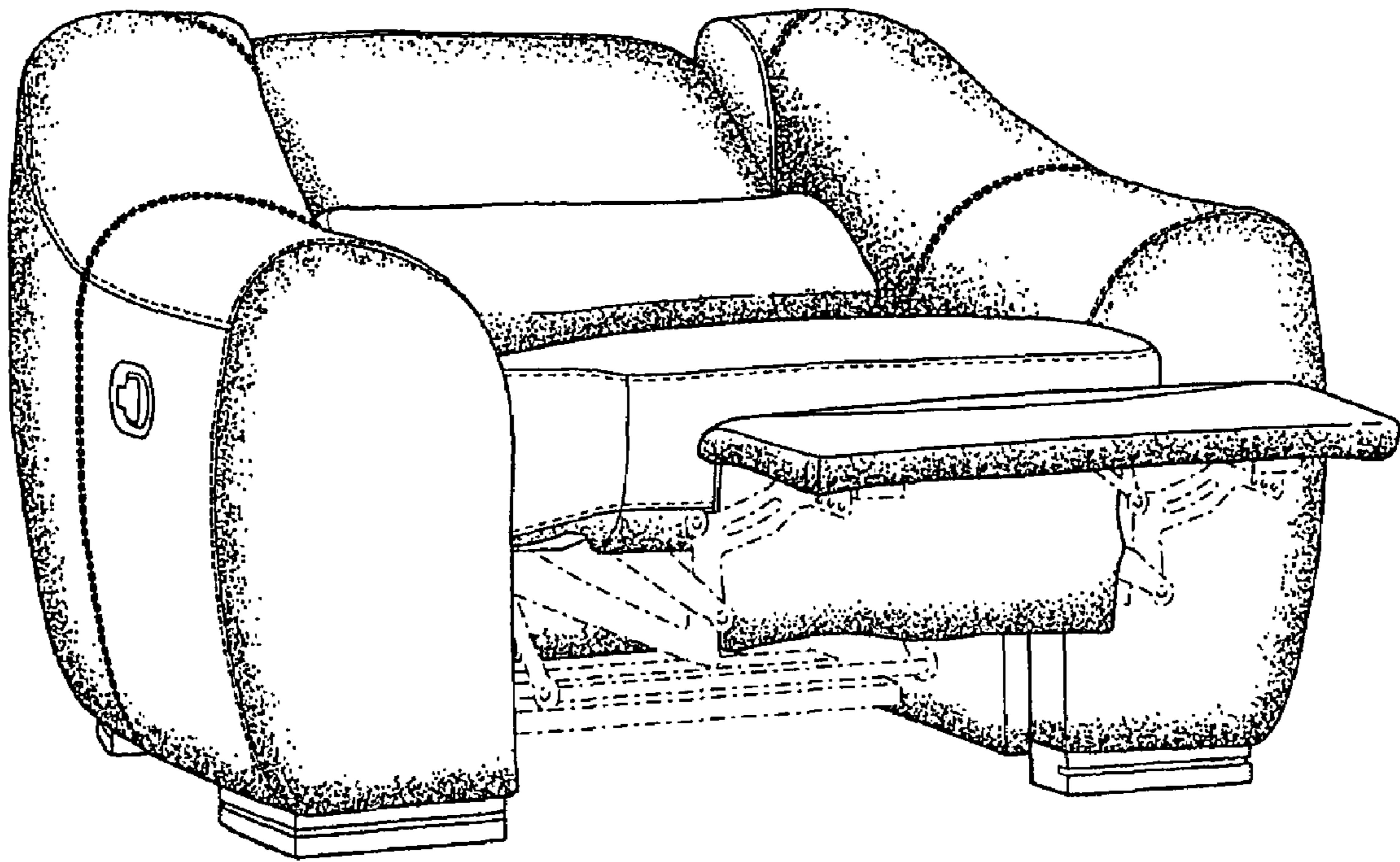

FIGURE 13