



US00D558976S

(12) **United States Design Patent**
Bailey et al.

(10) **Patent No.: US D558,976 S**
(45) **Date of Patent: ** Jan. 8, 2008**

(54) **HANDBAG**

D501,315 S * 2/2005 Delafontaine D3/246
D522,238 S * 6/2006 Stulman D3/243

(76) Inventors: **Christopher Bailey**, 58-59 Haymarket,
London SW1Y 4BL (GB); **Rory**
O'Hanlon, 58-59 Haymarket, London
SW1Y 4BL (GB)

* cited by examiner

Primary Examiner—Stella M. Reid
(74) *Attorney, Agent, or Firm*—Arnold & Porter LLP; Holly
Logue Prutz

(**) Term: **14 Years**

(21) Appl. No.: **29/232,798**

(57) **CLAIM**

(22) Filed: **Jun. 24, 2005**

The ornamental design for a handbag, as shown and
described.

(51) **LOC (8) Cl.** **03-01**

(52) **U.S. Cl.** **D3/243**

(58) **Field of Classification Search** D3/201,
D3/205, 226, 230–246, 254, 276, 289, 303,
D3/305, 322, 324, 327, 901–903; 190/109,
190/113, 1, 100, 119, 102–110, 112, 115;
150/110–115, 117–122, 127, 128, 130, 900,
150/902, 903

See application file for complete search history.

DESCRIPTION

FIG. 1 is a front left perspective view of a handbag showing
our new design;

FIG. 2 is a front view thereof;

FIG. 3 is a rear view thereof;

FIG. 4 is a right side view thereof;

FIG. 5 is a top view thereof; and,

FIG. 6 is a bottom view thereof.

The broken line showing in FIGS. 1–6 is included for the
purpose of illustrating the stitching that appears on portions
of the handbag.

(56) **References Cited**

U.S. PATENT DOCUMENTS

D275,241 S * 8/1984 Schimmel D3/243
D461,953 S * 8/2002 Guyon D3/243
D500,593 S * 1/2005 Stulman D3/243

1 Claim, 5 Drawing Sheets

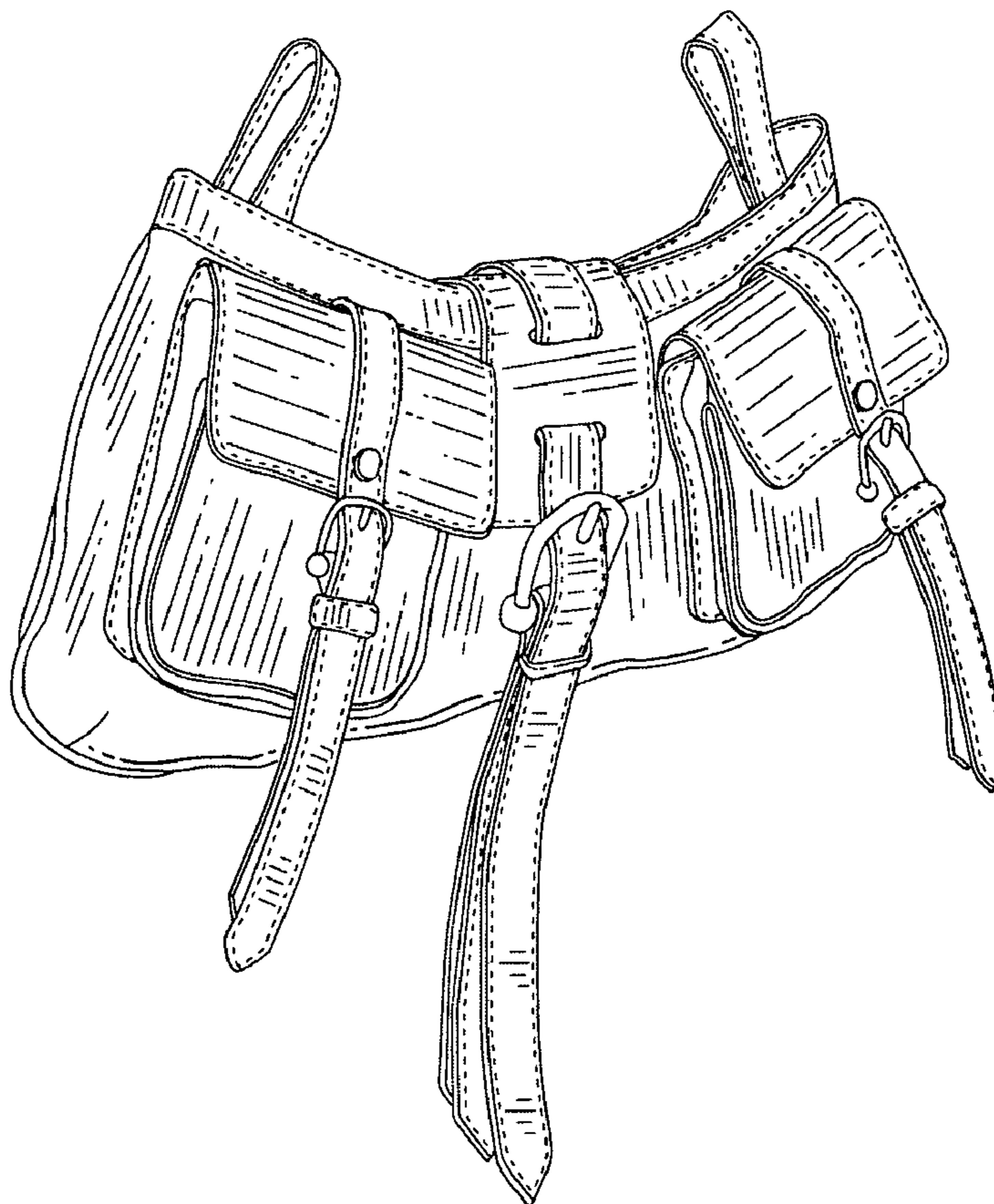

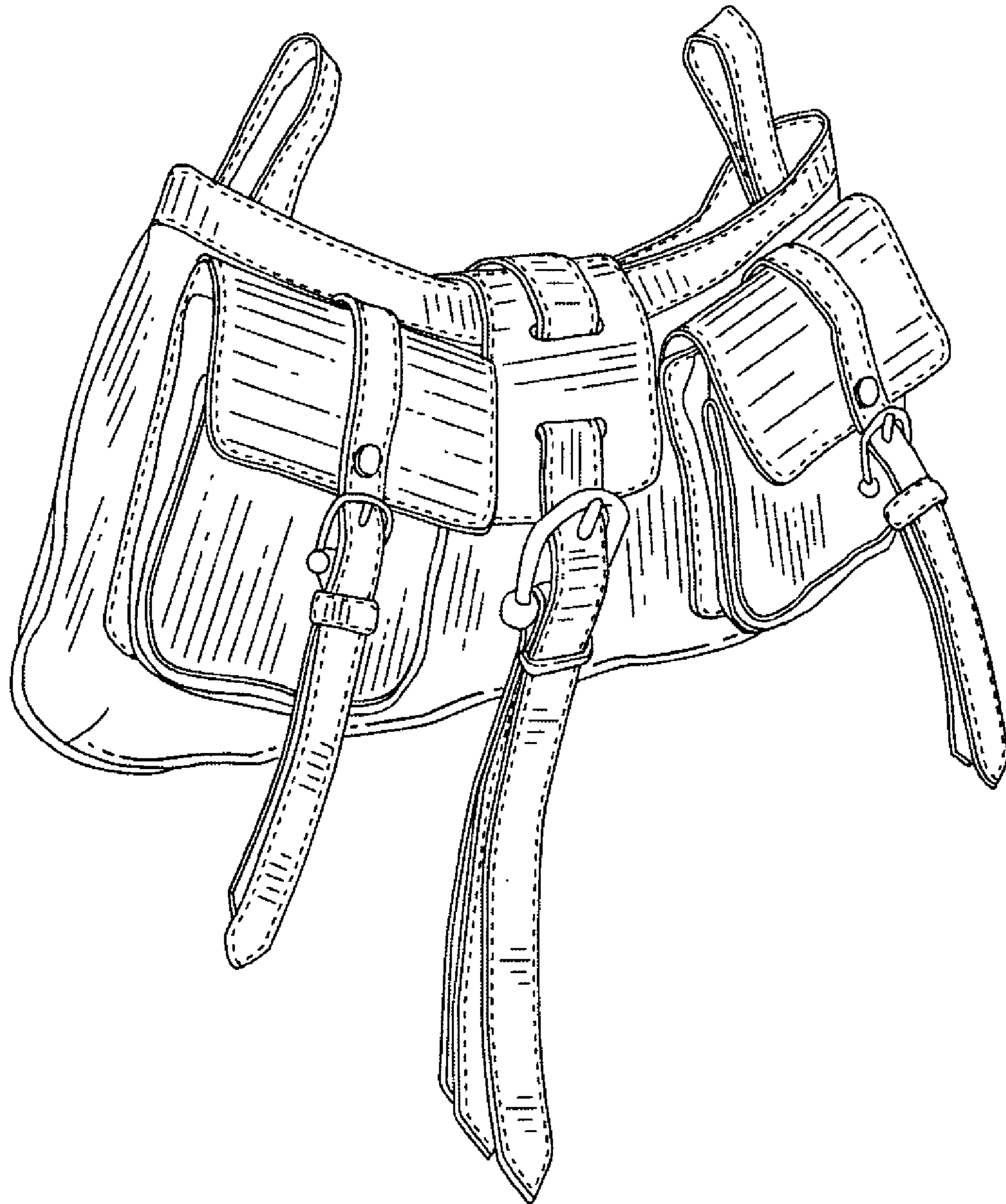

FIG. 1

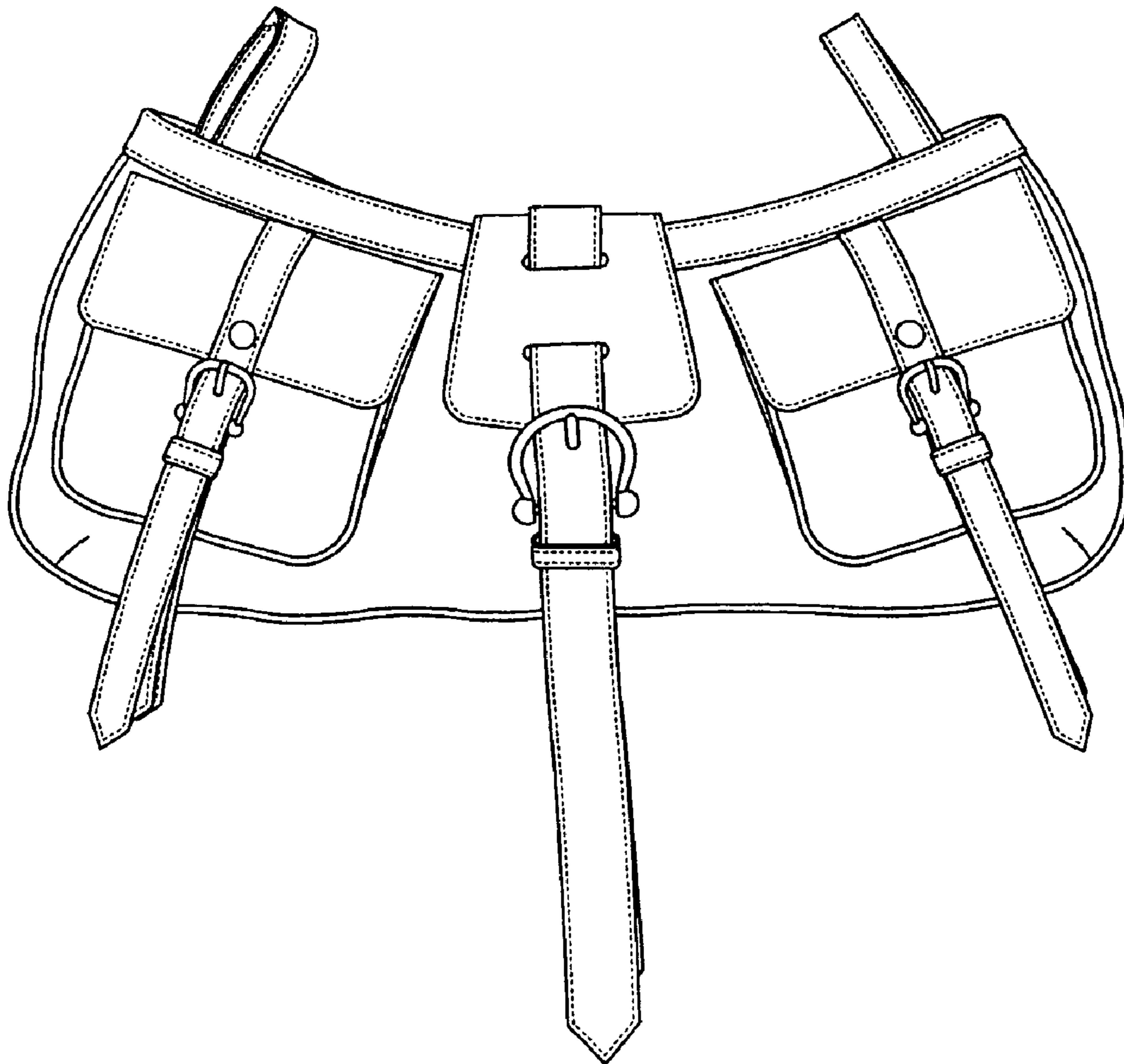

FIG. 2

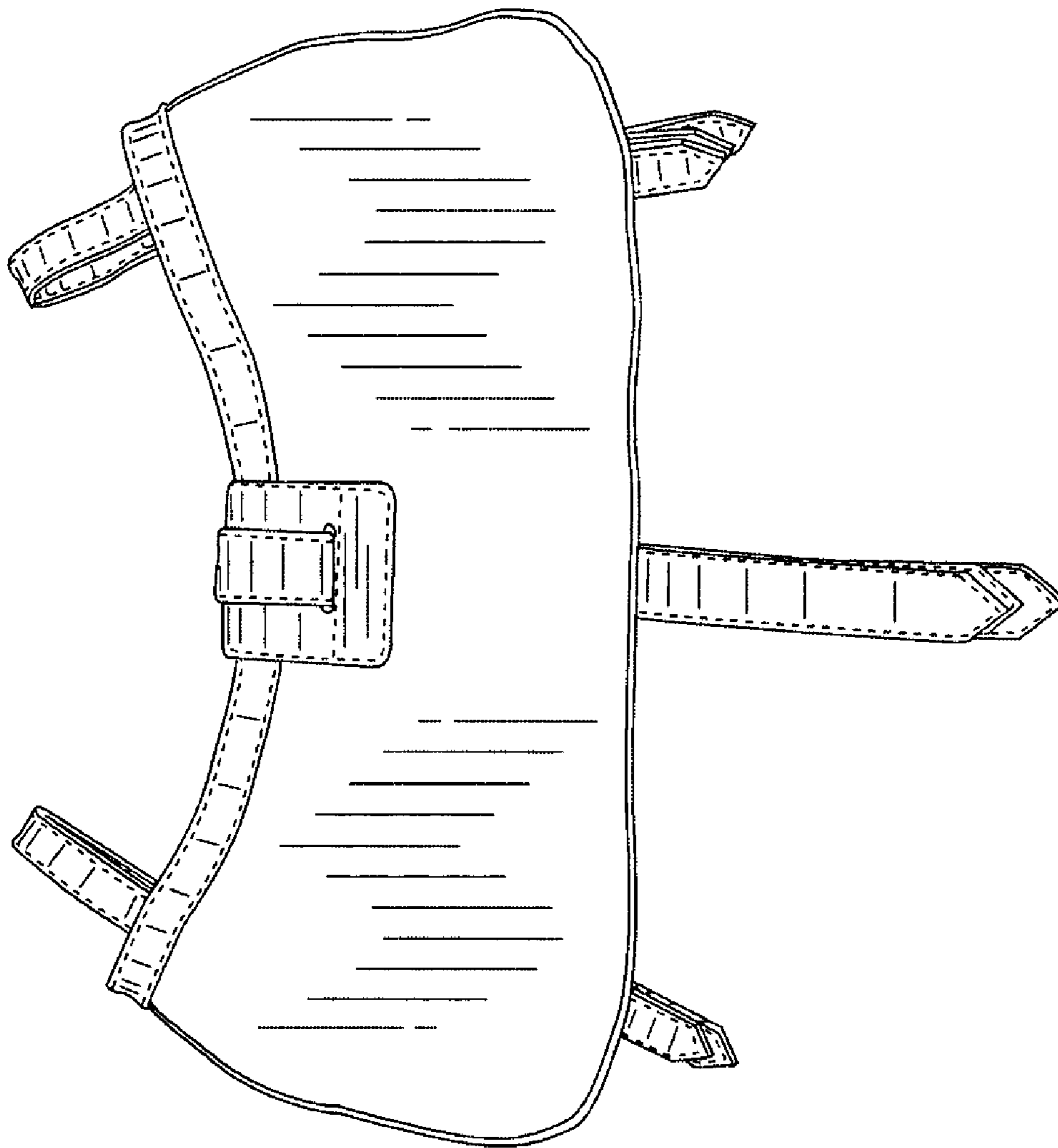

FIG. 3

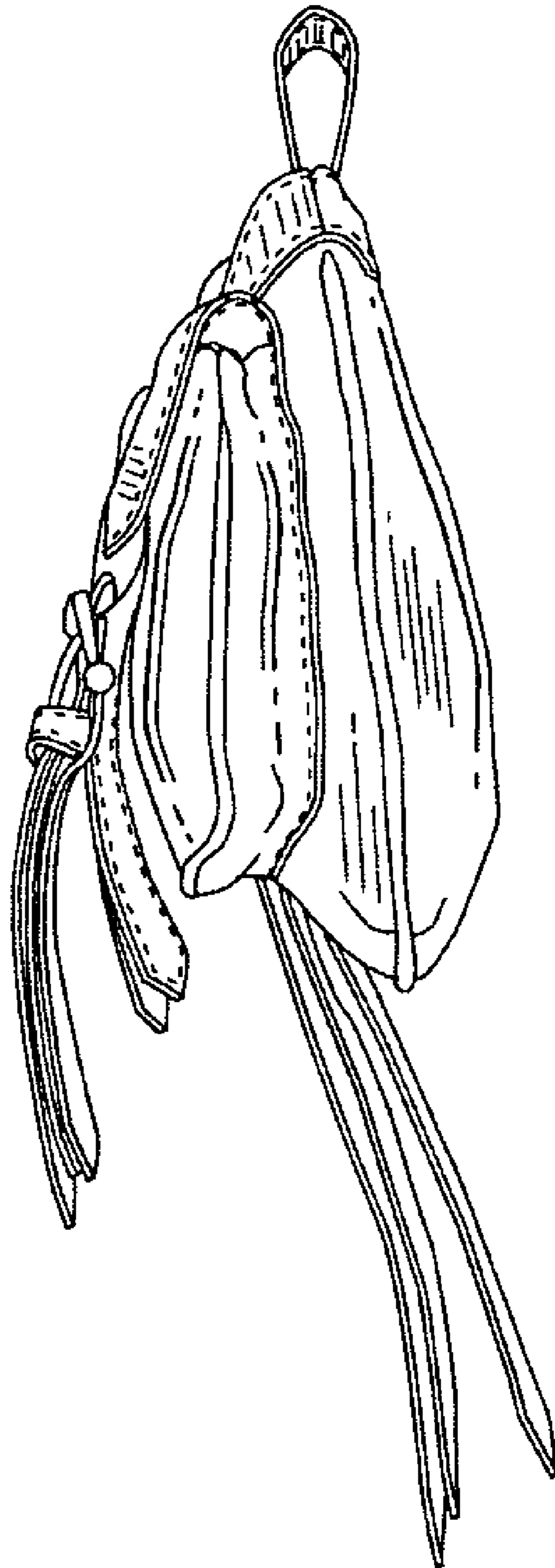

FIG. 4

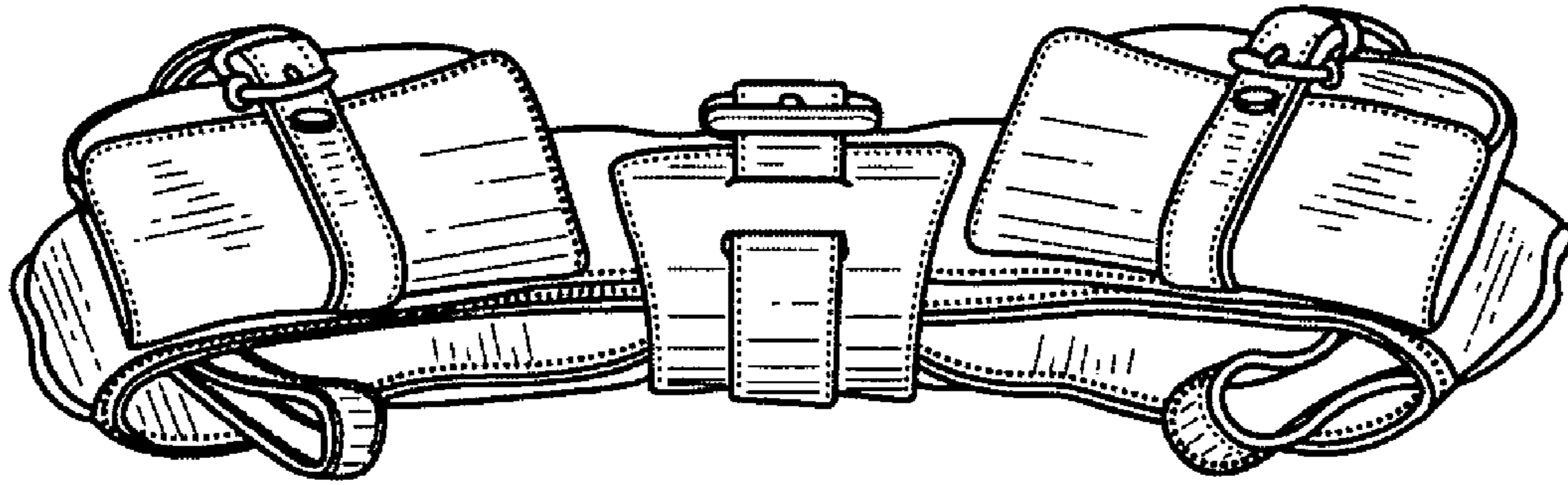

FIG. 5

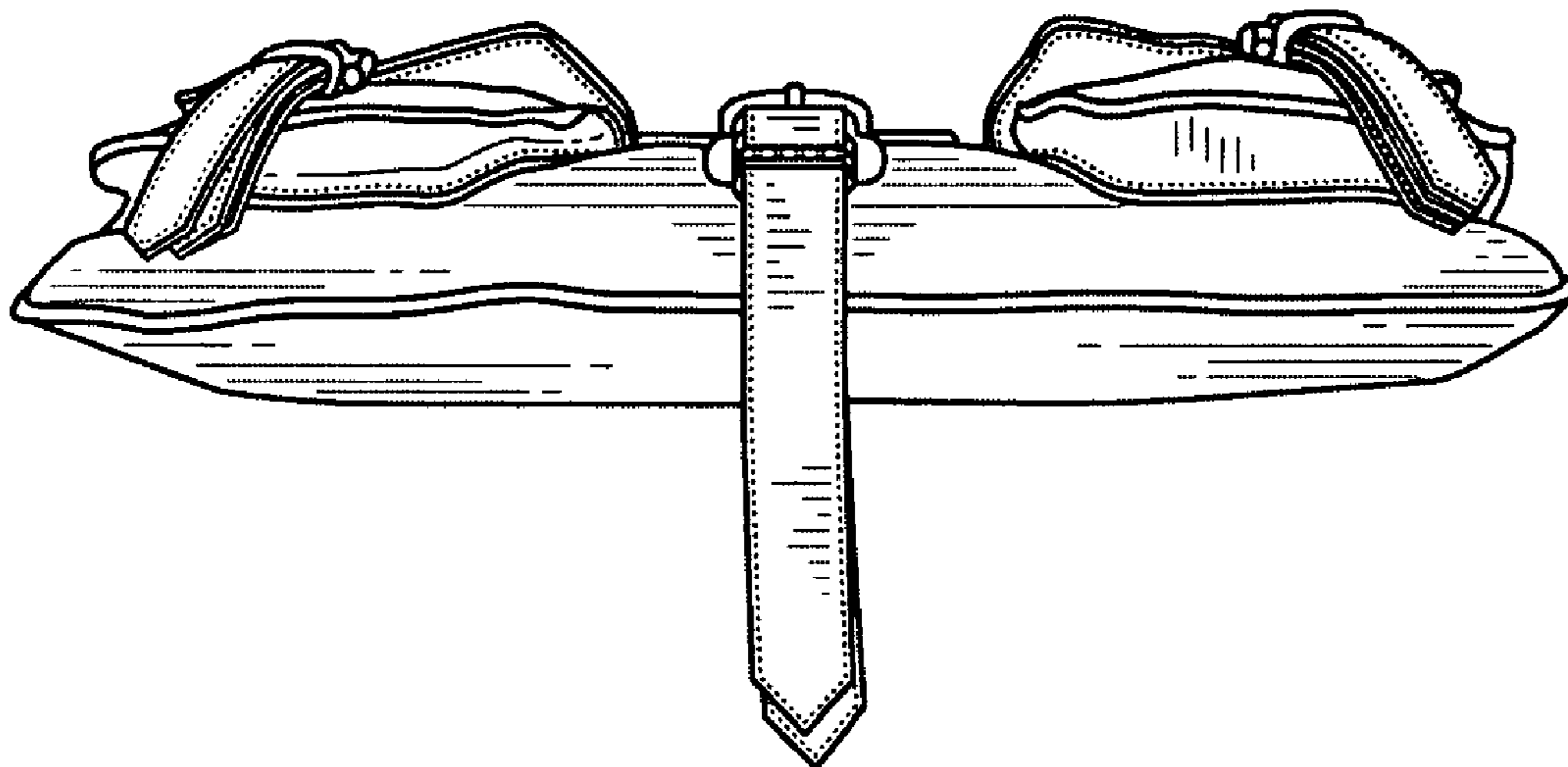

FIG. 6